

PEDESTALS, PULL OUT AND UNDER DESK UNITS

STORAGE: PEDESTALS, PULL OUT, AND UNDER DESK UNITS

● Available
□ Not available

Pedestals 22.5" High



22.5" D	22.5" H	22.5" H
17" W	●	●

Pedestals 25" High



22.5" D	25" H	25" H
13" W	●	□
17" W	□	●

Pedestals 29" High



29" H	24" D	30" D
17" W	●	●

STORAGE: PEDESTALS, PULL OUT, AND UNDER DESK UNITS

● Available
□ Not available

Desk End Combined Pedestal Tops

* Only applicable to 29" High Pedestal



	48" W	60" W
17" D	●	●

Pull Out Tower Units

29"-45" High



17" W	29" H	45" H
30" D	●	●
62" D	●	□

Under Desk Personal Storage Units

22" High

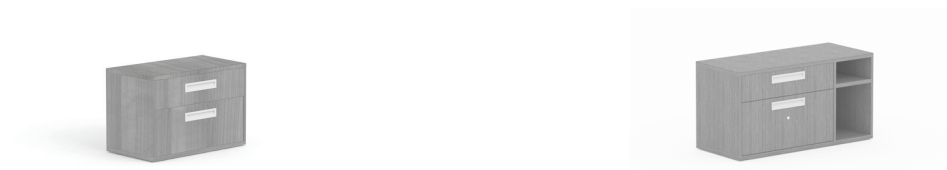

Personal Drawer / Lateral Drawer

Personal Drawer / Lateral Drawer / Open Space with Fixed Shelf

18" D	22" H	22" H
30" W	●	□
36" W	●	□
42" W	□	●

STORAGE: PEDESTALS, PULL OUT, AND UNDER DESK UNITS

PERSONAL STORAGE UNITS



Grain Direction
Grain direction side to side on horizontal panels and top to bottom on vertical panels.

1 x personal drawer
1 x file drawer (locking)
Open storage with shelf (42" wide option only)

42" wide option available in LH or RH

DIMENSIONS

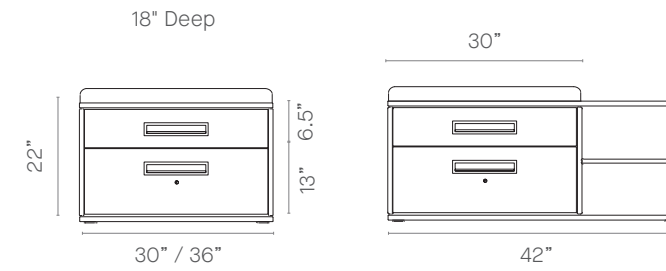

Seat pad optional

FEATURES

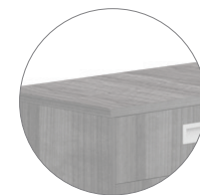

Upholstered seat pad as an option for collaboration and informal meetings.

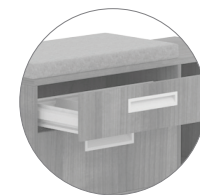

Drawers feature heavy duty full extending drawer runners with soft close to hold drawers shut and a steel drawer box.



42" wide option comes complete with additional open storage with a fixed shelf.

FILING

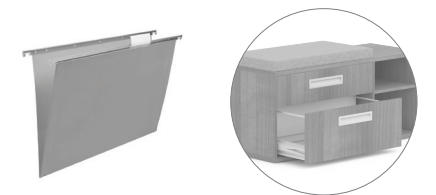

Filing drawer comes complete with filing cradle to support letter filing.

STORAGE: PEDESTALS, PULL OUT, AND UNDER DESK UNITS

PEDESTALS

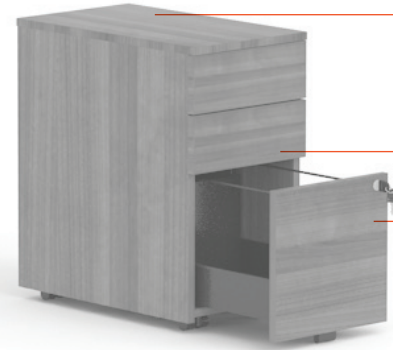

Grain Direction
Grain direction front to back on horizontal panels and top to bottom on vertical panels. Drawer fronts are side to side 24" deep desk high units, top panel grain runs front and back

All units feature locking bar and anti-tilt (heavy duty option also features drawer selector device)

Storage Options
22.5" High Units
1 x Personal drawer plus 1 x file drawer OR
3 x Personal drawer

25" High Units
2 x Personal drawer plus 1 x file drawer

29" High Units
2 x Personal drawer plus 1 x file drawer

DIMENSIONS

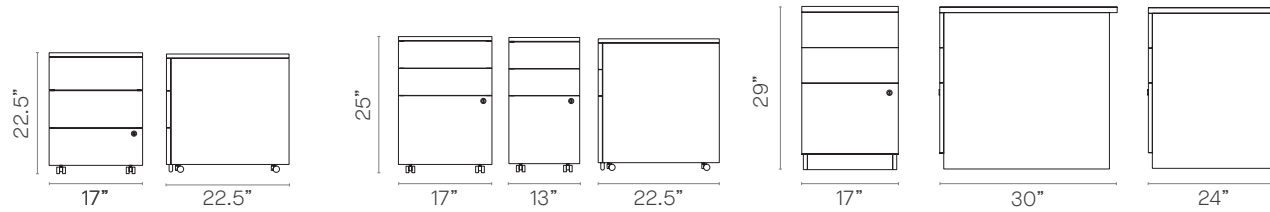

CONSTRUCTION – TFL PEDESTAL

All panels are 3/4" TFL with 2 mm laser edge band

* The 29" high pedestal has a 1" thick top to match the desk surface.

HEAVY DUTY DRAWERS

Heavy duty pedestals feature metal sided drawers, metal runners and 5/8" thick drawer base.

STORAGE: PEDESTALS, PULL OUT, AND UNDER DESK UNITS

ACCESSORIES – TFL PEDESTAL



Desk End Combined Pedestal Top*
48" or 62" wide

* Attaches to two desks back to back. Replaces standard desk high pedestal tops on installation. When a screen is trapped between two desks the extension top increases in size.

Filing Drawer Converter
Converts a filing drawer to high capacity storage.

FEATURES

Locking Bar
Locking bar allows one lock to lock all drawers safely securing items within.

Drawer Selector
Ensures only one drawer can be opened at any one time.

Anti-tilt
Bottom drawer filled with counterbalance to prevent unit becoming unstable.

FILING



Filing drawers accept letter files

STORAGE: PEDESTALS, PULL OUT, AND UNDER DESK UNITS

PULL OUT TOWER UNIT

Pull out depth: 27.5"



Grain Direction
Grain direction side to side on horizontal panels and drawer fronts, and top to bottom on vertical panels

- 2 x Storage Shelf
- 1 x Molded pen tray
- 2 x Soft close drawers (45" H only)
- 1 x Cubby (45" H only)
- 1 x Accessory rail (45" H only)
- Screen accessories (45" H only)

Available in LH and RH configurations

DIMENSIONS

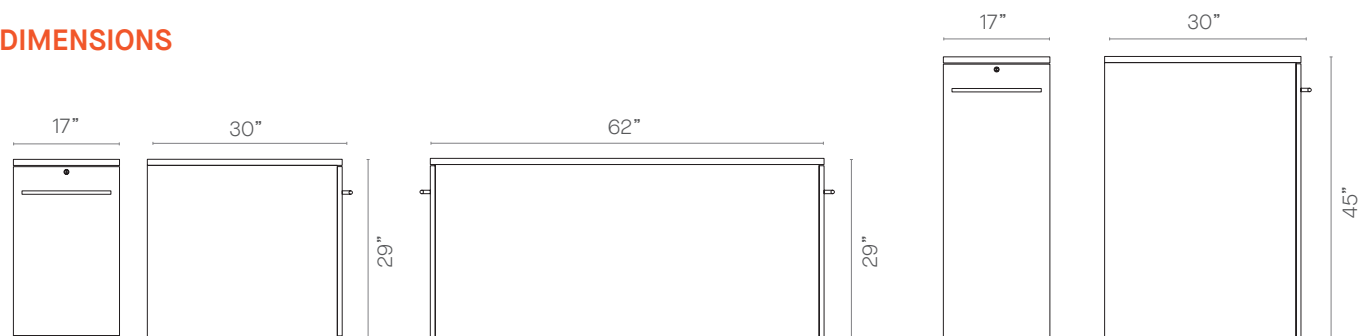

ADJUSTMENT (PULL OUT TOWER UNIT)

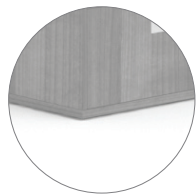

Concealed leveling foot offers 5/8" of adjustment.

ADJUSTMENT (OPEN PULL OUT UNIT)

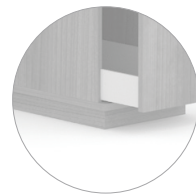

Concealed leveling foot which can be accessed from inside the unit, offers 1.25" of adjustment.

FEATURES (PULL OUT TOWER UNIT)

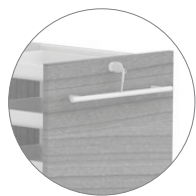

Features a pair of heavy duty full extensions drawer runners. Supported on casters with functional handle. Allows items to be safely stored and easily accessed.

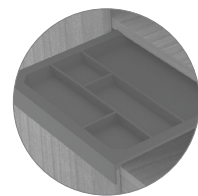

Pull out molded pen tray located discreetly under shelf.

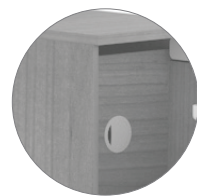

Cable port access gives access to power within the unit allowing items to be charged safely.



45" high option comes complete with storage cubby and 2 x soft close personal drawers.

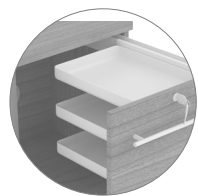

45" high option allows mounting of screen accessories such as paper trays for additional storage.

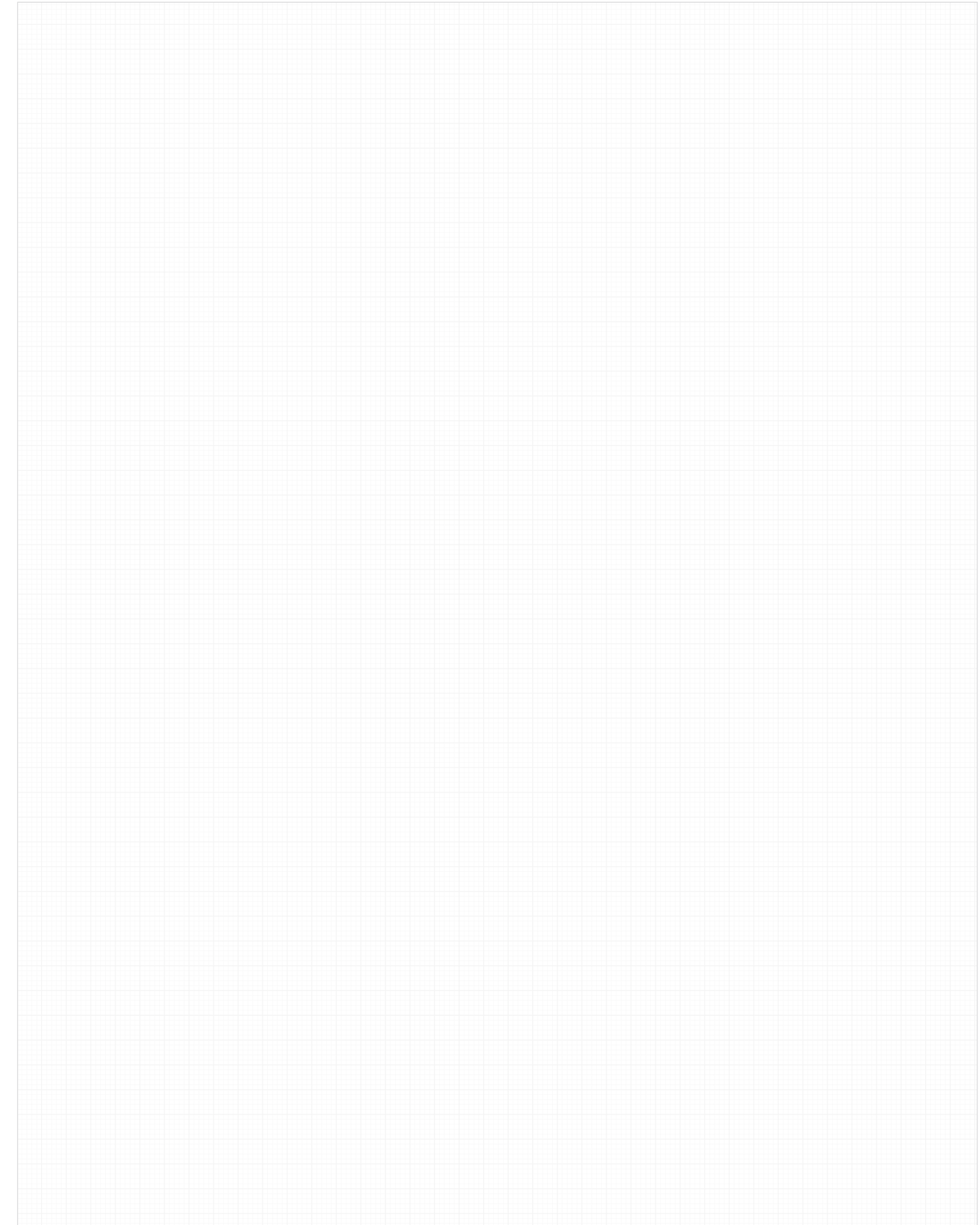

STORAGE: UNDER DESK MOBILE PEDESTALS

STORAGE: DESK HIGH STATIC PEDESTALS

22.5" H Box / File

22.5" depth
1 x box / 1 x file drawer
Drawer selector device, anti-tilt, and locking bar
Metal sided drawers
5/8" thick drawer base



Width (inch)		
13" W	17" W	
-	UMA2XD 752 SEE NOTES 1 & 3	Code TFL
-	UMA3XD 822 SEE NOTES 1 & 3	Code TFL
UNTMA3XD 870 SEE NOTE 2	-	Code TFL
-	UTMA3XD 883 SEE NOTES 2 & 3	Code TFL
UNMA2XD 740		

Note 1: If pen tray is required, please order a PTM for \$34.
 Note 2: If pen tray is required, please order a PTF for \$34.
 Note 3: Seat pad is optional and must be ordered separately.
[Click here to see details](#)

All prices listed in USD \$
 Ships KD = Knock Down (Assembly Required)

22.5" H Box / Box / Box

22.5" depth
3 x box drawers
Drawer selector device, anti-tilt, and locking bar
Metal sided drawers
5/8" thick drawer base



25" H Box / Box / File

22.5" depth
2 x box / 1 x file drawer
Drawer selector device, anti-tilt, and locking bar
Metal sided drawers
5/8" thick drawer base



25" H Box / Box / File

22.5" depth
2 x box / 1 x file drawer
Drawer selector device, anti-tilt, and locking bar
Metal sided drawers
5/8" thick drawer base



Mobile Ped

22.5" depth
22.5" height



29" H Box / Box / File

24" depth
2 x box / 1 x file drawer
Drawer selector device, anti-tilt, and locking bar
Metal sided drawers
5/8" thick drawer base



29" H Box / Box / File

30" depth
2 x box / 1 x file drawer
Drawer selector device, anti-tilt, and locking bar
Metal sided drawers
5/8" thick drawer base



Converts a filing drawer to high capacity storage

Width (inch)		
17" W		
U6DHA3XD 959 SEE NOTES 2 & 3		Code TFL
U8DHA3XD 1,088 SEE NOTES 1 & 3		Code TFL
UPFIF 81		Code Price

Note 1: If pen tray is required, please order a PTM for \$34.
 Note 2: If pen tray is required, please order a PTF for \$34.
 Note 3: Grain runs 'front to back,' if 'side to side' is required, add /SS to code.

All prices listed in USD \$
 Ships KD = Knock Down (Assembly Required)

Finishes & Features Available...

TFL HD Highland Oak | UM Urban Maple | WH White | AT Autumn | WK Winter Oak | SO Strata Oak | CW Carini Walnut | DN Denim | LG Light Gray

To specify your storage...

1. Select the Codes of the individual items you need to achieve your configuration
2. Choose Finishes where appropriate: 'top' finishes / frame color / fabric color

STORAGE: PEDESTALS

Desk End Combined Pedestal Top

22.5" depth

Attaches to 2 desks, back to back
Replaces standard desk height pedestal top on installation
Does not include pedestals



Desk End Combined Pedestal Top

22.5" depth

Attaches to 2 desks, back to back
Replaces standard desk height pedestal top on installation
Does not include pedestals



Width (inch)		Code
50" W	62" W	
<p>UP50DE 227</p>	<p>—</p>	TFL
<p>—</p>	<p>UP62DE 252</p>	TFL

All prices listed in USD \$
Ships KD = Knock Down (Assembly Required)

STORAGE: PULL OUT TOWER UNITS

29" H Single Pull Out Tower

30" depth

Pull out tower unit



29" H Double Pull Out Tower

62" depth

Double pull out tower unit
Drawer selector device, 62" deep desk end storage unit to be used on end of back to back desks

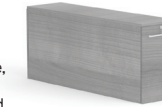

45" H Single Pull Out Tower

30" depth

Pull out tower unit



Width (inch)		Code
18" W		
<p>M2930-FD 1,996</p> <p>SEE NOTES 1 & 2</p>		TFL
<p>M2962-FD 3,249</p> <p>SEE NOTE 1</p>		TFL
<p>M4530-FD 2,807</p> <p>SEE NOTES 1 & 2</p>		TFL

Note 1: Please specify Silver, Black, or White pulls
Note 2: Please specify if L/H or R/H (right hand shown)

All prices listed in USD \$
Ships KD = Knock Down (Assembly Required)

Finishes & Features Available...

TFL	HD Highland Oak UM Urban Maple WH White AT Autumn WK Winter Oak SO Strata Oak CW Carini Walnut DN Denim LG Light Gray
Pull Color	Silver Black White

To specify your storage...

- Select the Codes of the individual items you need to achieve your configuration
- Choose Finishes where appropriate: "top" finishes / frame color / fabric color

STORAGE: UNDER DESK PERSONAL UNIT

22" H Box / Lateral
18" depth
1 x file drawer
1 x personal box drawer



22" H Box / Lateral / Open
18" depth
1 x file drawer
1 x personal box drawer
1 x open space with fixed shelf



22" H Combination Cabinet
18" depth
2 x door
1 x box drawer
1 x lateral file drawer



22" H Storage Cabinet
18" depth
2 x sliding doors



Width (inch)			Code
30" W	36" W	42" W	
<p>M2230-2DW 2,182</p> <p>SEE NOTES 1 & 3</p>	<p>M2236-2DW 2,207</p> <p>SEE NOTES 1 & 3</p>	-	TFL
-	-	<p>M2242-2DW 2,239</p> <p>SEE NOTES 1, 2, & 3</p>	TFL

Width (inch)				Code
30" W	36" W	66" W	72" W	
-	-	<p>M2266-2DW2DR 2,900</p> <p>SEE NOTES 1 & 3</p>	<p>M2272-2DW2DR 3,119</p> <p>SEE NOTES 1 & 3</p>	TFL
<p>M2230-SL 1,926</p> <p>SEE NOTES 1 & 3</p>	<p>M2236-SL 1,986</p> <p>SEE NOTES 1 & 3</p>	-	-	TFL

Note 1: Please specify Silver, Black, or White pulls
 Note 2: Please specify if L/H or R/H (left hand shown)
 Note 3: Seat pad is optional and must be ordered seperately.
[Click here to see details](#)

All prices listed in USD \$
 Ships KD = Knock Down (Assembly Required)

Finishes & Features Available...

TFL	HD Highland Oak UM Urban Maple WH White AT Autumn WK Winter Oak SO Strata Oak CW Carini Walnut DN Denim LG Light Gray
Pull Color	Silver Black White

STORAGE: UNDER DESK PERSONAL UNIT

22" H Open / Lateral
18" depth
1 x lateral file drawer
1 x open shelf



22" H Book Case
18" depth
1 x opening with fixed shelf

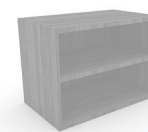

Width (inch)			Code
24" W	30" W	36" W	
-	<p>M2230-DW 1,926</p> <p>SEE NOTES 1 & 2</p>	<p>M2236-DW 1,986</p> <p>SEE NOTES 1 & 2</p>	TFL
<p>M2224-C 793</p> <p>SEE NOTE 2</p>	<p>M2230-C 839</p> <p>SEE NOTE 2</p>	<p>M2236-C 865</p> <p>SEE NOTE 2</p>	TFL

Note 1: Please specify Silver, Black, or White pulls
 Note 2: Seat pad is optional and must be ordered separately.
[Click here to see details.](#)

All prices listed in USD \$
 Ships KD = Knock Down (Assembly Required)

To specify your storage...

1. Select the Codes of the individual items you need to achieve your configuration
2. Choose Finishes where appropriate: 'top' finishes / frame color / fabric color

STORAGE: SEAT PADS

18" D Storage Seat Pad

Seat pad adheres to the top of personal storage units for informal meetings and collaboration sessions.



Width (inch)					
15" W	30" W	36" W	42" W	66" W	72" W
MSP15	MSP30	MSP36	MSP42	MSP66	MSP72
80	128	149	169	248	256
108	179	216	255	355	372
154	258	324	394	535	561
197	341	430	535	716	894
242	421	540	675	894	938
* 1.25 yds	* 1.25 yds	* 1.25 yds	* 1.25 yds	* 1.25 yds	* 1.25 yds

Code
Grade 0
Grade 1 / COM
Grade 2
Grade 3
Grade 4

22.5" D Storage Seat Pad

Seat pad adheres to the top of personal storage units for informal meetings and collaboration sessions.



Width (inch)	
17" W	
MSP17	
100	
141	
203	
265	
327	
* 1.25 yds	

Code
Grade 0
Grade 1 / COM
Grade 2
Grade 3
Grade 4

All prices listed in USD \$

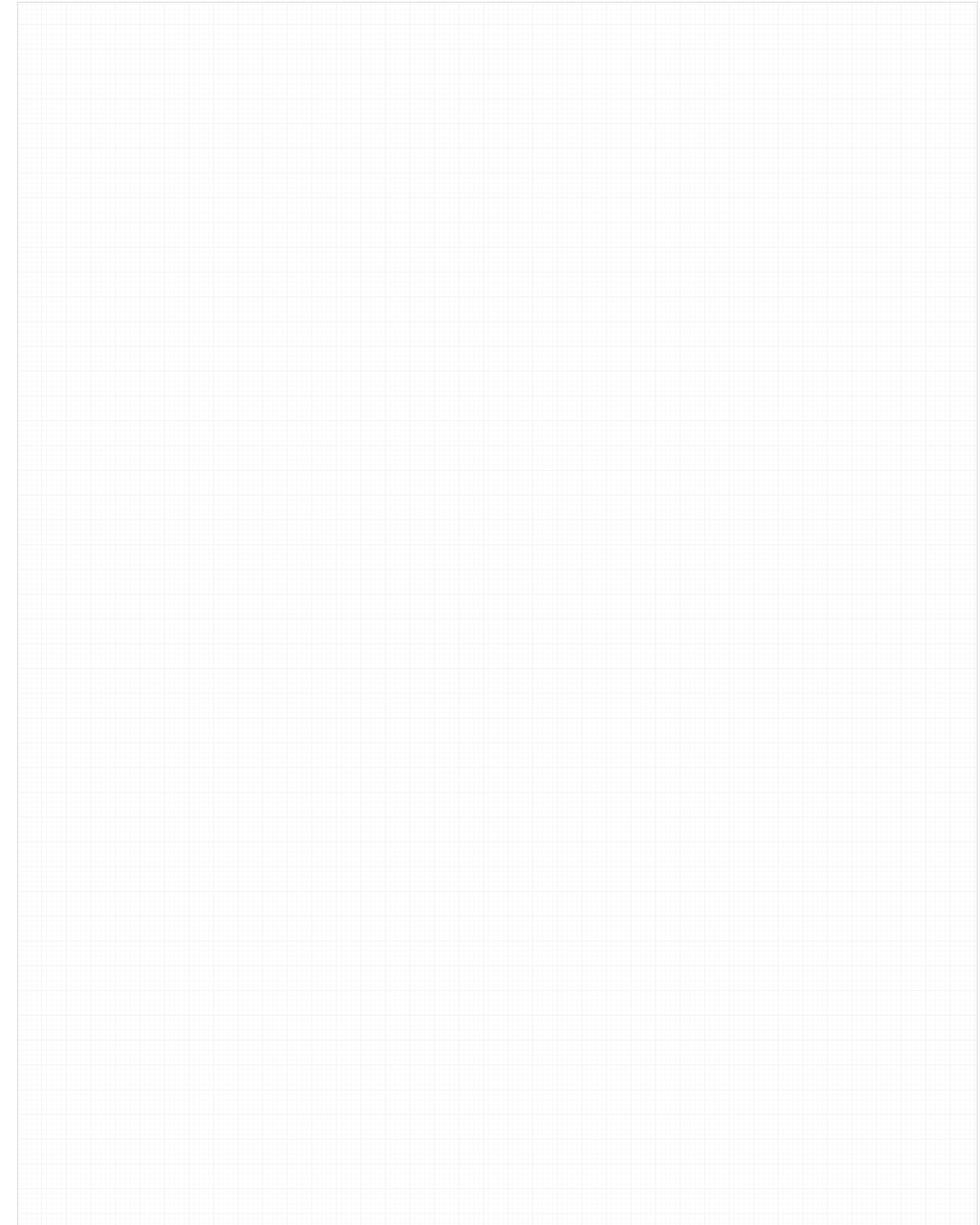

Finishes & Features Available...

Grade 0, 1, 2, 3, 4

[Click here to see available Fabric Options](#)

STORAGE DESK END UNITS

● Available
□ Not available

Desk End Storage Sliding Door Unit



18" D	29" H	45" H	62" H
62" W	●	●	●

Desk End Lockers

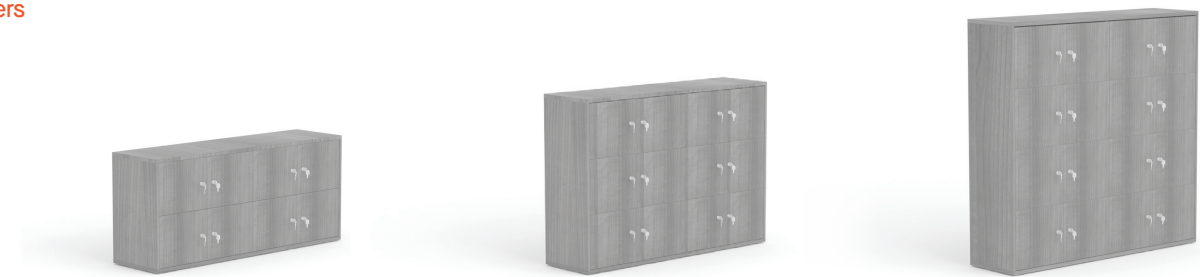

18" D	29" H	45" H	62" H
62" W	●	●	●

Desk End Lockers and Printer Hub



18" D	45" H
62" W	●

[Click here to see details](#)

DESK END UNITS

STORAGE: DESK END UNITS

STORAGE: DESK END UNITS

DESK END STORAGE WITH SLIDING DOORS

DESK END LOCKERS AND PRINTER HUB



Grain Direction
Grain direction front to back on horizontal panels and top to bottom on vertical panels.

Storage Options
29" high with one fixed storage shelf
45" high with two fixed storage shelves
62" high with three fixed storage shelves

Sliding doors offer a practical alternative to hinged doors where space is limited and comes complete with soft close fixings.



Grain Direction
Grain direction front to back on horizontal panels and top to bottom on vertical panels

6 x personal lockers with individual key locks
2 x open shelf unit complete with cable port access.

DIMENSIONS

18" Deep

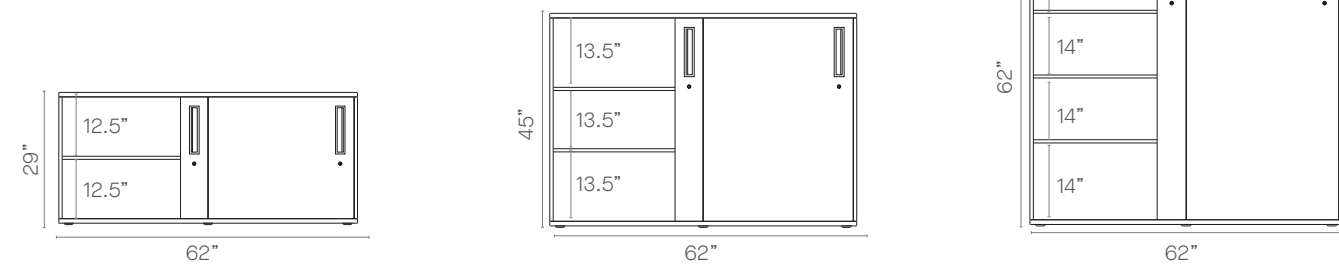

DIMENSIONS

18" Deep

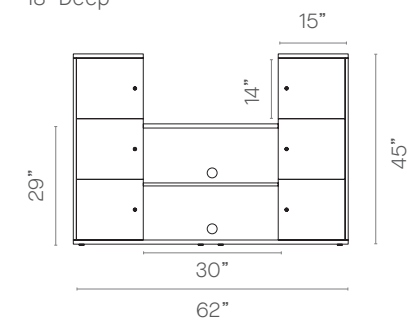

FEATURES



Printer can be positioned on either the top shelf or discretely in either of the open shelves below.

DESK END LOCKERS



Grain Direction
Grain direction front to back on horizontal panels and top to bottom on vertical panels.

Individual key locks

Storage Options
29" high with eight personal lockers
45" high with twelve personal lockers
62" high with sixteen personal lockers

DIMENSIONS

18" Deep

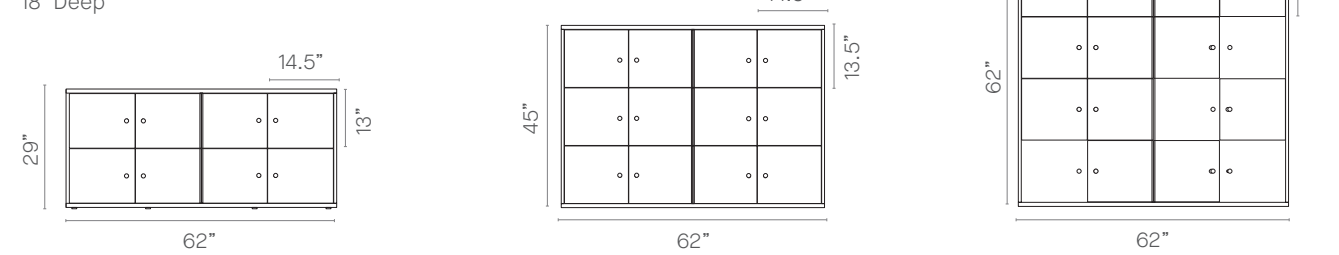

STORAGE: DESK END UNITS

29" H Desk End Storage with Sliding Doors

18" depth
Sliding door unit



45" H Desk End Storage with Sliding Doors

18" depth
Sliding door unit



62" H Desk End Storage with Sliding Doors

18" depth
Sliding door unit



Width (inch)			
62" W			
	M2962-SL	Code TFL	
	2,612		
	SEE NOTE 1		
	M4562-SL	Code TFL	
	2,888		
	SEE NOTE 1		
	M6262-SL	Code TFL	
	3,213		
	SEE NOTE 1		

Note 1: Please specify Silver, Black, or White pulls

All prices listed in USD \$

Ships KD = Knock Down (Assembly Required)

STORAGE: DESK END UNITS

29" Desk End Lockers

18" depth
Locker unit



45" Desk End Lockers

18" depth
Locker unit



62" Desk End Lockers

18" depth
Locker unit



45" Desk End Printer Hub

18" depth
Locker and Printer Hub



Width (inch)			
62" W			
	M2962-LU	Code TFL	
	1,844		
	SEE NOTE 1		
	M4562-LU	Code TFL	
	2,574		
	SEE NOTE 1		
	M6262-LU	Code TFL	
	3,350		
	SEE NOTE 1		
	M4562-LP	Code TFL	
	2,458		
	SEE NOTE 1		

Note 1: Please specify Silver, Black, or White pulls

All prices listed in USD \$

Ships KD = Knock Down (Assembly Required)

Finishes & Features Available...

TFL	HD Highland Oak UM Urban Maple WH White AT Autumn WK Winter Oak SO Strata Oak CW Carini Walnut DN Denim LG Light Gray
Pull Color	Silver Black White

To specify your storage...

1. Select the Codes of the individual items you need to achieve your configuration
2. Choose Finishes where appropriate: 'top' finishes / frame color / fabric color

MODULAR STORAGE

STORAGE: DESK, SCREEN, AND SPACE DIVIDER HEIGHT

● Available
□ Not available

Desk Height 29" High

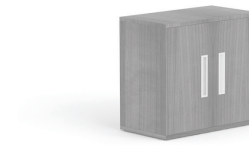

2 Door



2 x Personal Drawers
1 x File Drawer



2 x File Drawers

18" D	29" H	29" H	29" H
30" W	●	●	●
36" W	●	●	●

Screen Height 45" High



2 x File Drawers
1 x Flipper Drawer



2 x File Drawers
1 x Closed Back Section



2 x File Drawers
1 x Open Back Section



File Drawer
2 x Personal Drawers
1 x Flipper Unit



File Drawer
2 x Personal Drawers
1 x Closed Back Section

18" D	45" H	45" H	45" H	45" H	45" H
30" W	●	●	●	●	●
36" W	●	●	●	●	●

Screen Height 45" High



1 x File Drawer
2 x Personal Drawers
1 x Open Back Section



2 Doors
1 x Flipper Door



2 Doors
1 x Closed Back Section

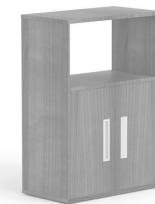

2 Doors
1 x Open Back Section



3 x File Drawers

18" D	45" H	45" H	45" H	45" H	45" H
30" W	●	●	●	●	●
36" W	●	●	●	●	●

STORAGE: DESK, SCREEN, AND SPACE DIVIDER HEIGHT

● Available
□ Not available

Space Divider
62" High



18" D	62" H	62" H	62" H	62" H
30" W	●	●	●	●
36" W	●	●	●	●

Space Divider
62" High



18" D	62" H	62" H	62" H	62" H
30" W	●	●	●	●
36" W	●	●	●	●

Space Divider
62" High



18" D	62" H	62" H	62" H	62" H
30" W	●	●	●	●
36" W	●	●	●	●

STORAGE: DESK, SCREEN, AND SPACE DIVIDER HEIGHT

DESK HEIGHT – 29"



Grain Direction
Grain direction front to back on horizontal panels and top to bottom on vertical panels.

Storage Options
Multiple storage configurations available

DIMENSIONS

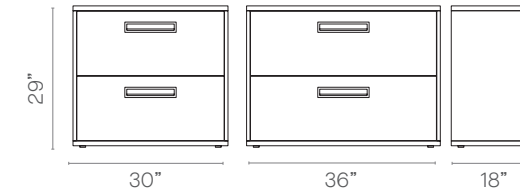

SCREEN HEIGHT – 45"



Grain Direction
Grain direction front to back on horizontal panels and top to bottom on vertical panels.

Storage Options
Multiple storage configurations available

DIMENSIONS

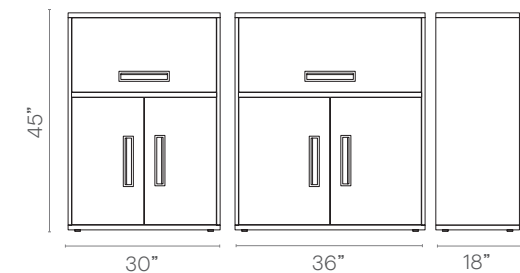

STORAGE: DESK, SCREEN, AND SPACE DIVIDER HEIGHT

SPACE DIVIDER HEIGHT – 62"



Grain Direction
Grain direction front to back on horizontal panels and top to bottom on vertical panels.

Storage Options
Multiple storage configurations available, please see features below.

DIMENSIONS



FEATURES

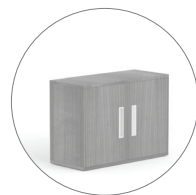

Doors
Features 95 degree sprung inset mounted hinges, rim lock with catch plate and adjustable divider shelf.



Personal Drawer
Features heavy duty full extension drawer runners with soft close to hold drawer shut and a steel drawer box.

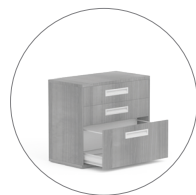

Filer Drawer
Features heavy duty full extension drawer runners with soft close to hold drawer shut and a steel drawer box comes complete with a filing cradle for letter filing.



Open Shelf*
Ideal for display storage.



Closed Shelf*
Ideal for shelf storage.



Flipper*
Utilizes top box lift up mechanism.

* Only available in screen height and/or space divider

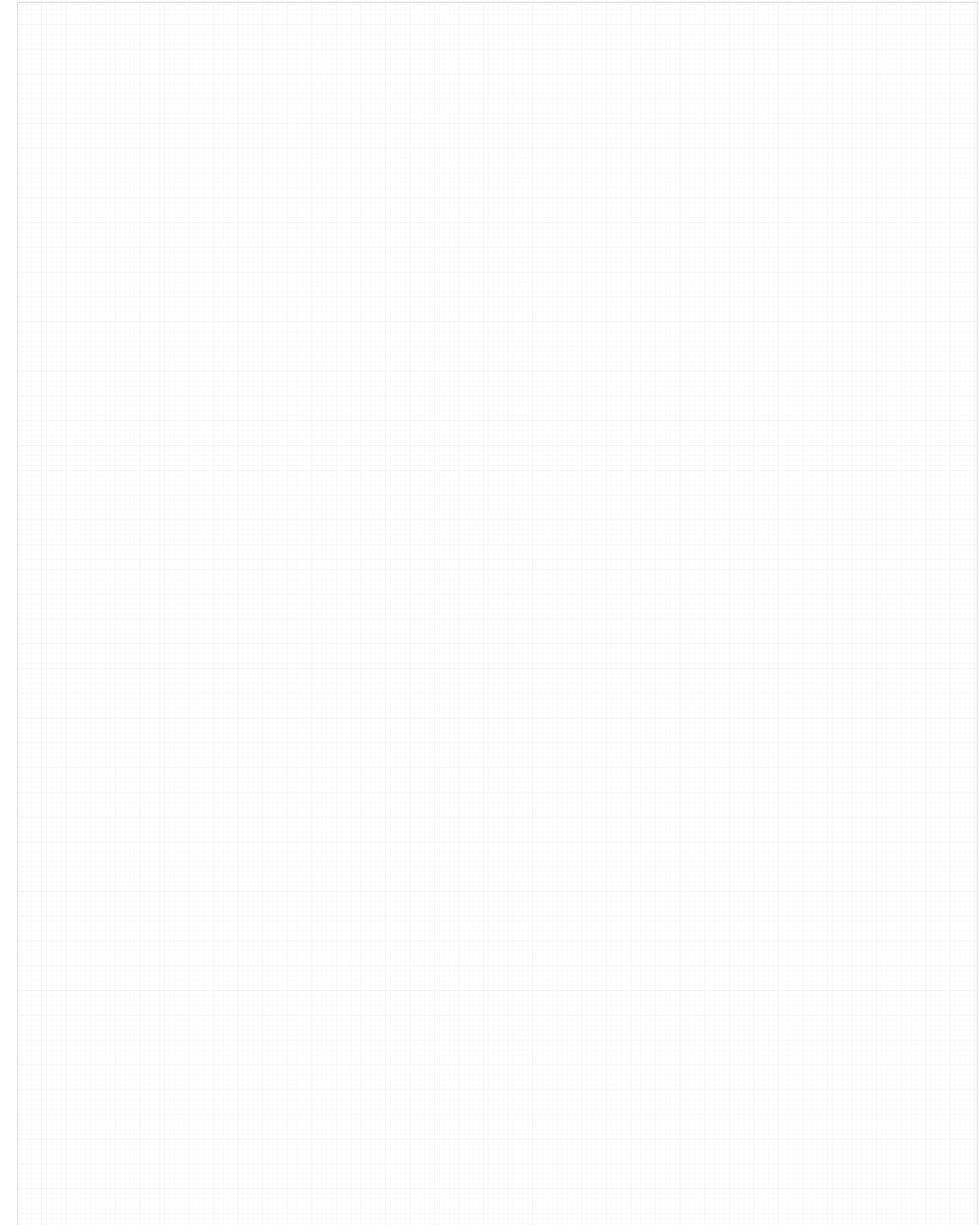

STORAGE: DESK HEIGHT

29" H Desk Height Storage
18" depth
2 x doors



29" H Desk Height Storage
18" depth
2 x personal drawers
1 x file drawer



29" H Desk Height Storage
18" depth
2 x file drawers



Width (inch)		Code
30" W	36" W	TFL
M2930-2DR 947 SEE NOTE 1	M2936-2DR 1,108 SEE NOTE 1	
M2930-3DW 2,647 SEE NOTE 1	M2936-3DW 2,761 SEE NOTE 1	
M2930-2DW 2,180 SEE NOTE 1	M2936-2DW 2,279 SEE NOTE 1	

STORAGE: SCREEN HEIGHT

45" H Freestanding Storage
18" depth
2 x file drawers
1 x flipper door



45" H Freestanding Storage
18" depth
2 x file drawers
1 x closed back section



45" H Freestanding Storage
18" depth
2 x file drawers
1 x open back section



Width (inch)		Code
30" W	36" W	TFL
M4530-2DWF 2,684 SEE NOTE 1	M4536-2DWF 2,756 SEE NOTE 1	
M4530-2DWC 2,381 SEE NOTE 1	M4536-2DWC 2,435 SEE NOTE 1	
M4530-2DWO 2,325 SEE NOTE 1	M4536-2DWO 2,385 SEE NOTE 1	

Note 1: Please specify Silver, Black, or White pulls

All prices listed in USD \$

If Under 63": Ships Fully Assembled
If Over 63": Ships KD = Knock Down (Assembly Required)

Finishes & Features Available...

TFL	HD Highland Oak UM Urban Maple WH White AT Autumn WK Winter Oak SO Strata Oak CW Carini Walnut DN Denim LG Light Gray
Pull Color	Silver Black White

STORAGE: SCREEN HEIGHT

45" H Freestanding Storage
18" depth
1 x file drawer
2 x personal drawers
1 x flipper door



45" H Freestanding Storage
18" depth
1 x file drawer
2 x personal drawers
1 x closed back section



45" H Freestanding Storage
18" depth
1 x file drawer
2 x personal drawers
1 x open back section



45" H Freestanding Storage
18" depth
2 x doors
1 x flipper door



45" H Freestanding Storage
18" depth
2 x doors
1 x closed back section



45" H Freestanding Storage
18" depth
2 x doors
1 x open back section



45" H Freestanding Storage
18" depth
3 x file drawers



Width (inch)		Code
30" W	36" W	TFL
M4530-3DWF 3,238 SEE NOTE 1	M4536-3DWF 3,350 SEE NOTE 1	
M4530-3DWC 2,935 SEE NOTE 1	M4536-3DWC 3,102 SEE NOTE 1	
M4530-3DWO 2,880 SEE NOTE 1	M4536-3DWO 2,982 SEE NOTE 1	
M4530-2DRF 1,462 SEE NOTE 1	M4536-2DRF 1,533 SEE NOTE 1	
M4530-2DRC 1,187 SEE NOTE 1	M4536-2DRC 1,224 SEE NOTE 1	
M4530-2DRO 1,154 SEE NOTE 1	M4536-2DRO 1,188 SEE NOTE 1	
M4530-3DW 3,113 SEE NOTE 1	M4536-3DW 3,202 SEE NOTE 1	

Note 1: Please specify Silver, Black, or White pulls







All prices listed in USD \$

If Under 63": Ships Fully Assembled
If Over 63": Ships KD = Knock Down (Assembly Required)

To specify your storage...

1. Select the Codes of the individual items you need to achieve your configuration
2. Choose Finishes where appropriate: 'top' finishes / frame color / fabric color

STORAGE: SPACE DIVIDERS





		Width (inch)			
		30" W	36" W		
62" H Freestanding Storage 18" depth 2 x file drawers 2 x closed back sections		M6230-2DW2C 2,589 SEE NOTE 1	M6236-2DW2C 3,446 SEE NOTE 1	Code	TFL
62" H Freestanding Storage 18" depth 2 x file drawers 2 x flipper doors		M6230-2DW2F 3,211 SEE NOTE 1	M6236-2DW2F 3,561 SEE NOTE 1	Code	TFL
62" H Freestanding Storage 18" depth 2 x file drawers 1 x closed back section 1 x flipper door		M6230-2DWCF 2,976 SEE NOTE 1	M6236-2DWCF 3,237 SEE NOTE 1	Code	TFL
62" H Freestanding Storage 18" depth 2 x file drawers 1 x open back section 1 x flipper door		M6230-2DWOF 2,851 SEE NOTE 1	M6236-2DWOF 3,188 SEE NOTE 1	Code	TFL
62" H Freestanding Storage 18" depth 1 x file drawer 2 x personal drawers 2 x closed back sections		M6230-3DW2C 3,198 SEE NOTE 1	M6236-3DW2C 3,488 SEE NOTE 1	Code	TFL
62" H Freestanding Storage 18" depth 1 x file drawer 2 x personal drawers 2 x flipper doors		M6230-3DW2F 3,719 SEE NOTE 1	M6236-3DW2F 4,108 SEE NOTE 1	Code	TFL

Note 1: Please specify Silver, Black, or White pulls

All prices listed in USD \$

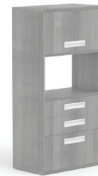
If Under 63": Ships Fully Assembled
 If Over 63": Ships KD = Knock Down (Assembly Required)

STORAGE: SPACE DIVIDERS

		Width (inch)			
		30" W	36" W		
62" H Freestanding Storage 18" depth 1 x file drawer 2 x personal drawers 1 x closed back section 1 x flipper door		M6230-3DWCF 3,500 SEE NOTE 1	M6236-3DWCF 3,794 SEE NOTE 1	Code	TFL
62" H Freestanding Storage 18" depth 1 x file drawer 2 x personal drawers 1 x open back section 1 x flipper door		M6230-3DWOF 3,448 SEE NOTE 1	M6236-3DWOF 3,736 SEE NOTE 1	Code	TFL
62" H Freestanding Storage 18" depth 2 x doors 2 x closed back sections		M6230-2DR2C 1,436 SEE NOTE 1	M6236-2DR2C 1,505 SEE NOTE 1	Code	TFL
62" H Freestanding Storage 18" depth 2 x doors 2 x flipper doors		M6230-2DR2F 1,967 SEE NOTE 1	M6236-2DR2F 2,078 SEE NOTE 1	Code	TFL
62" H Freestanding Storage 18" depth 2 x doors 1 x closed back section 1 x flipper door		M6230-2DRCF 1,603 SEE NOTE 1	M6236-2DRCF 1,687 SEE NOTE 1	Code	TFL
62" H Freestanding Storage 18" depth 2 x doors 1 x open back section 1 x flipper door		M6230-2DR2F 1,554 SEE NOTE 1	M6236-2DR2F 1,681 SEE NOTE 1	Code	TFL

Note 1: Please specify Silver, Black, or White pulls
 Note 2: Please specify if L/H or R/H (left hand shown)

All prices listed in USD \$
 If Under 63": Ships Fully Assembled
 If Over 63": Ships KD = Knock Down (Assembly Required)

Finishes & Features Available...

TFL	HD Highland Oak UM Urban Maple WH White AT Autumn WK Winter Oak SO Strata Oak CW Carini Walnut DN Denim LG Light Gray
Pull Color	Silver Black White

To specify your storage...

- Select the Codes of the individual items you need to achieve your configuration
- Choose Finishes where appropriate: 'top' finishes / frame color / fabric color

HANG ON

STORAGE: HANG ON

● Available
 □ Not available

Hang On
 62" High



Storage Cupboard



Media Unit
 TV/Monitor Not Included

19.5" D	62" H	62" H
65" W	●	●

Hang On
 62" High



Closed Shelf Unit



Personal Locker

19.5" D	62" H	62" H
65" W	●	●

Accessories

62" Wide

Modular back panels link seamlessly with hang on storage, allowing greater versatility and use. As well as a standard TFL panel, you can also specify an acoustic or dry erase option.



Acoustic Header*



Dry Erase Header*

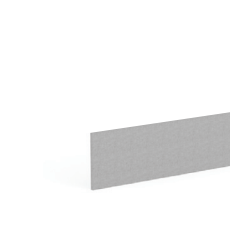

Acoustic Kicker



TFL Rear Panel

*Acoustic Header and Dry Erase Header must be ordered with an Acoustic Kicker

STORAGE: HANG ON

HANG ON



TV/Monitor Not Included

Grain Direction
Grain direction side to side on horizontal panels and top to bottom on vertical panels. Locker door fronts are side to side.

Storage Options
Storage Cupboard: 4 x Door / 3 x Shelf
Media Unit
Closed Shelf Unit
Personal Lockers

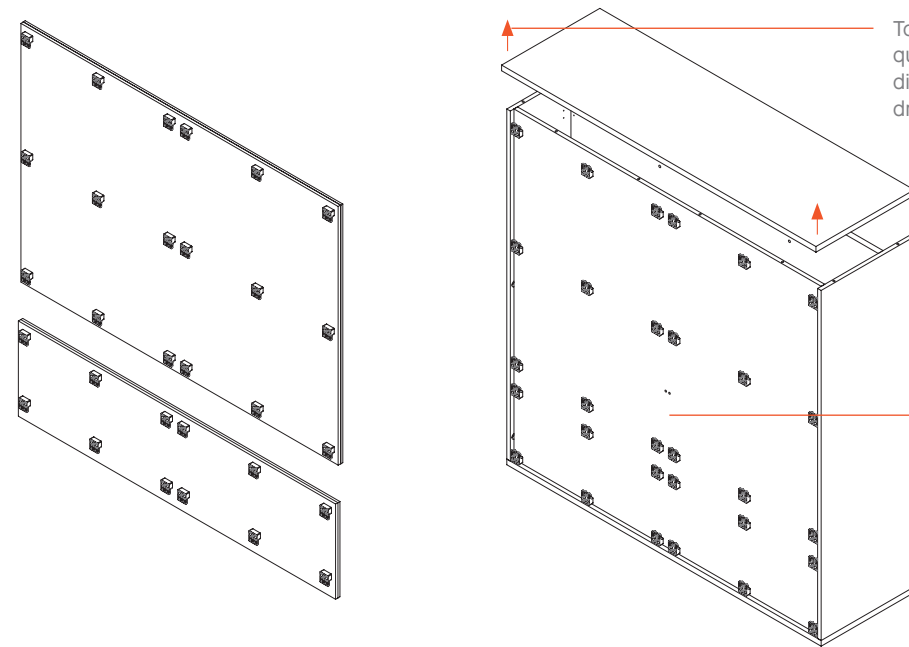

Top can be easily removed via quick release fittings allowing different accessory panels to be dropped in to place.

These versatile units allow Acoustic, Dry Erase and TFL panels to be easily interchanged. A rear panel must be ordered with the unit.

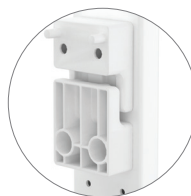

Panels are simply dropped into place using the pre-positioned 'male' and 'female' mounting clips.

STORAGE: HANG ON

ACCESSORIES



Acoustic Rear Panels allow the user to create an interesting space while controlling environments with high noise levels.



Dry Erase Panels are effective in numerous settings that require spontaneous, interactive, quick feedback.



TFL Rear Panel allows the back to match with the complete unit.

UNIT TYPES



Storage Unit
6 x adjustable shelves with lockable doors

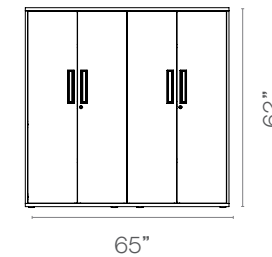

Personal Locker
12 x personal locker doors with individual locks

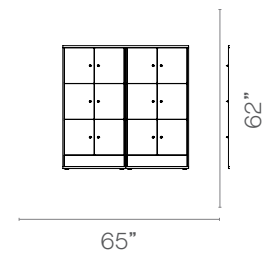

Media Unit
2 x adjustable shelves with lockable doors. Media mounting display panel

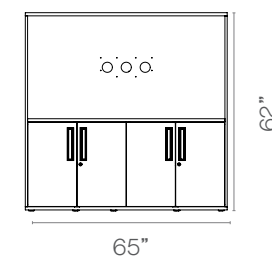

Closed Shelf Unit
2 x fixed shelves 2 x adjustable shelves with lockable doors

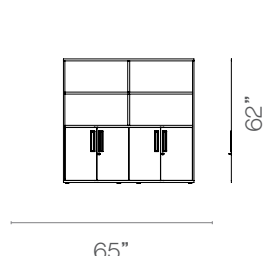

* All units are 19.5" deep overall when an accessory back hung on the rear of the unit.

STORAGE: HANG ON

62" H Storage Cupboard

19.5" depth
6 x shelves
Lockable doors



62" H Media Unit

19.5" depth



62" H Closed Shelf Unit

19.5" depth
2 x fixed shelves
2 x adjustable shelves
Lockable doors



62" H Personal Locker

19.5" depth
12 x personal lockers
Individual locking doors



Width (inch)	
65" W	
<p>HO6562-4DR 3,345</p> <p>SEE NOTES 1 & 2</p>	Code TFL
<p>HO6562-MU 3,223</p> <p>SEE NOTES 1 & 2</p>	Code TFL
<p>HO6562-CS 2,925</p> <p>SEE NOTES 1 & 2</p>	Code TFL
<p>HO6562-LU 4,395</p> <p>SEE NOTE 2</p>	Code TFL

Note 1: Please specify Silver, Black, or White pulls
Note 2: Storage units are knocked down

All prices listed in USD \$
If Under 63": Ships Fully Assembled
If Over 63": Ships KD = Knock Down (Assembly Required)

STORAGE: HANG ON ACCESSORIES

Back Acoustic Header



Dry Erase Header



Back Acoustic Kicker



TFL Rear Panel



Width (inch)	
65" W	
<p>HOAH65 1,091</p> <p>SEE NOTES 1 & 2</p>	Code Price
<p>HODWBP65 1,035</p> <p>SEE NOTE 1</p>	Code Price
<p>HOAK65 630</p> <p>SEE NOTE 2</p>	Code Price
<p>HOBP65 473</p>	Code TFL

Note 1: Headers must be ordered with a kicker
Note 2: Upholstered in Camira Blazer

All prices listed in USD \$
If Under 63": Ships Fully Assembled
If Over 63": Ships KD = Knock Down (Assembly Required)

Finishes & Features Available...

TFL	HD Highland Oak UM Urban Maple WH White AT Autumn WK Winter Oak SO Strata Oak CW Carini Walnut DN Denim LG Light Gray
Pull Color	Silver Black White
Fabric	Camira Blazer

To specify your storage...

- Select the Codes of the individual items you need to achieve your configuration
- Choose Finishes where appropriate: "top" finishes / frame color / fabric color

MOTE STORAGE

STORAGE: MOTE

● Available
□ Not available

Mote Low Board Storage
23" High

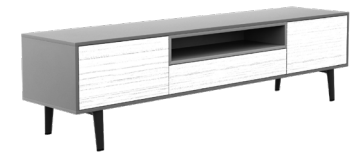

20" D	1 Single Drawer 1 Mitred insert 1 Door	1 Single Drawer 1 Mitred insert 2 Door
63" W	●	-
87" W	-	●

STATEMENT OF LINE

STORAGE: MOTE

● Available
□ Not available

Mote Side Board Storage
29" High



20" D	2 Single Drawers 1 Mitred Insert	1 Filing Drawer 1 Mitred insert	1 Drop Down 1 Mitred insert
40" W	●	●	●



20" D	2 Single Drawers 1 Mitred Insert 1 Door	1 Filing Drawer 1 Mitred insert 1 Door	1 Drop Down 1 Mitred insert 1 Door
63" W	●	●	●



20" D	2 Single Drawers 1 Mitred Insert 2 Doors	1 Filing Drawer 1 Mitred insert 2 Doors	1 Drop Down 1 Mitred insert 2 Doors
87" W	●	●	●

STATEMENT OF LINE

STORAGE: MOTE

● Available
□ Not available

Mote High Board Storage
35.5" High



20" D	3 Single Drawers 1 Mitred Insert	1 Filing Drawer 1 Mitred insert 1 Single Drawer	1 Drop Down 1 Mitred insert 1 Single Drawer
40" W	●	●	●



20" D	3 Single Drawers 1 Mitred Insert 1 Door	1 Filing Drawer 1 Mitred insert 1 Single Drawer 1 Door	1 Drop Down 1 Mitred insert 1 Single Drawer 1 Door
63" W	●	●	●



20" D	3 Single Drawers 1 Mitred Insert 1 Door with fridge & wine rack	1 Filing Drawer 1 Mitred insert 1 Single Drawer 1 Door with fridge & wine rack	1 Drop Down 1 Mitred insert 1 Single Drawer 1 Door with fridge & wine rack
63" W	●	●	●

STORAGE: MOTE

MOTE STORAGE LOW BOARD



Storage Combinations – mitred insert as standard
 63" combination options
 1 x single drawer, 1 x door
 87" combination options
 1 x single drawer, 2 x door

Grain Direction
 Grain direction side to side on all panels.

DIMENSIONS

20" Deep

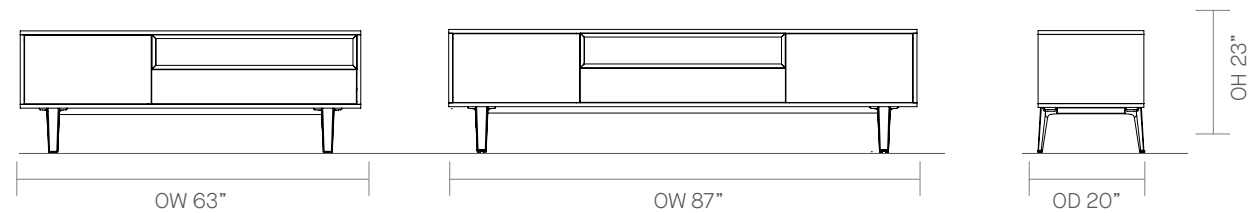

Optional cable management

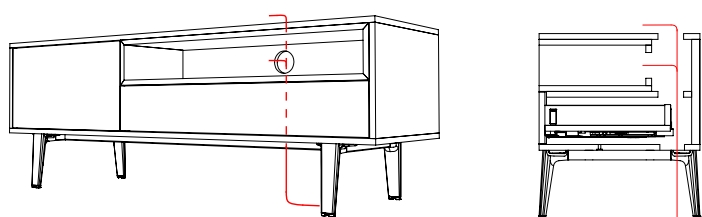

STORAGE: MOTE

MOTE STORAGE SIDE BOARD

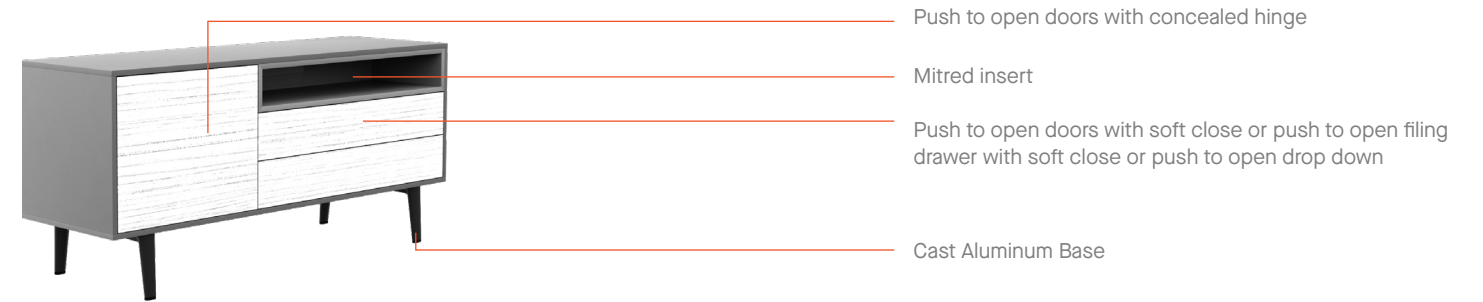

Storage Combinations – mitred insert as standard
 40" combination options
 2 x single drawer
 1 x filing drawer
 1 x drop down
 63" combination options
 2 x single drawer, 1 x door
 1 x filing drawer, 1 x door
 1 x drop down, 1 x door
 87" combination options
 2 x single drawer, 2 x door
 1 x filing drawer, 2 x door
 1 x drop down, 2 x door

Grain Direction
 Grain direction side to side on all panels.

DIMENSIONS

20" Deep

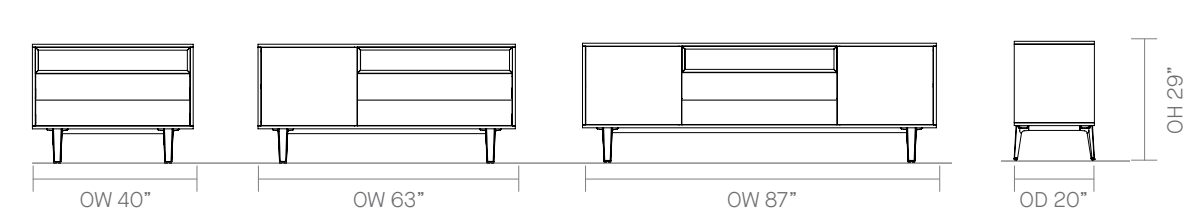

Optional cable management

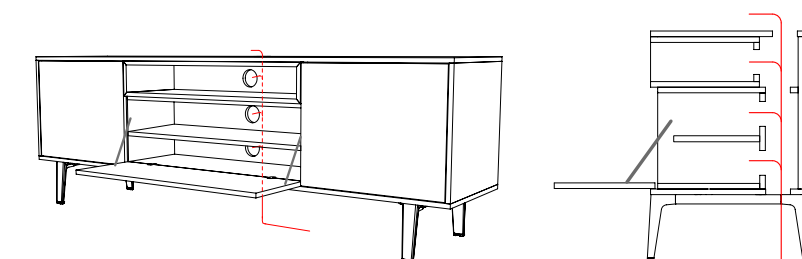

STORAGE: MOTE

MOTE STORAGE HIGH BOARD

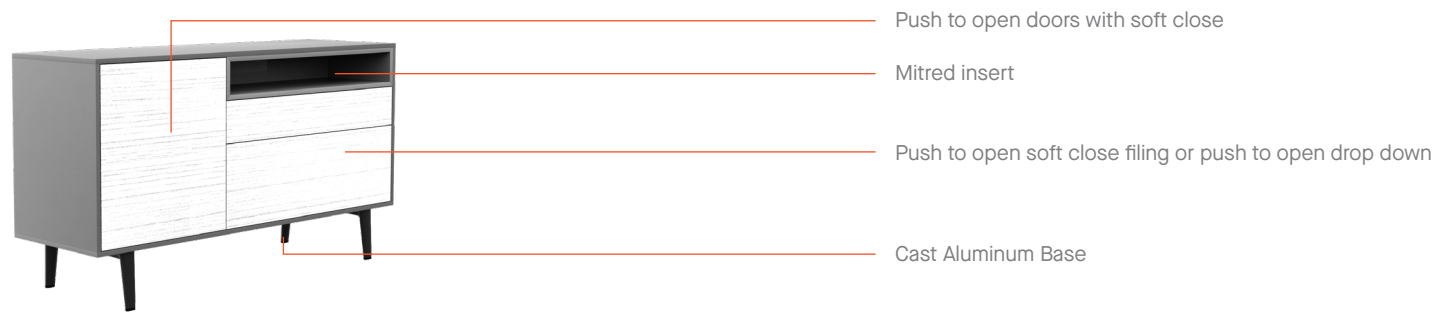

Storage Combinations – mitred insert as standard
 40" combination options
 3 x single drawer
 1 x single, 1 x filing drawer
 63" combination options
 3 x single drawer, 1 door
 1 x single, 1 x filing drawer, 1 x door
 1 x single, 1 x drop down, 1 x door
 87" combination options
 3 x single drawer, 1 x door with fridge/wine rack
 1 x single, 1 x drop down, 1 x door with fridge/wine rack

Grain Direction
 Grain direction side to side on all panels.

DIMENSIONS

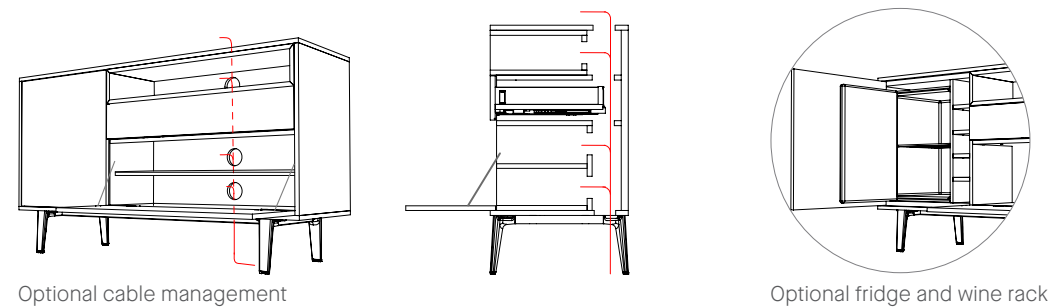
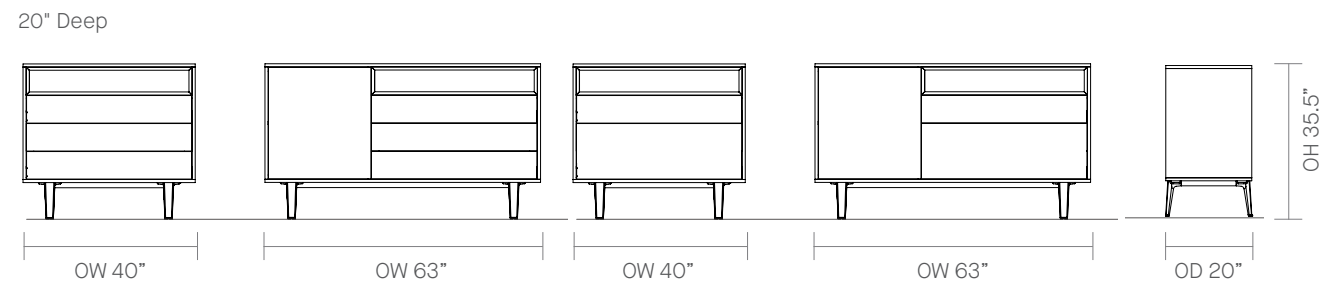

STORAGE: MOTE LOW BOARD

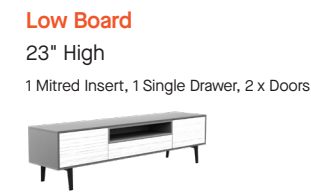

Width (inch)			Code
40" W	63" W	87" W	
-	MSL63DRDWC 3,671	-	TFL
-	-	MSL872DRDWC 4,378	TFL

All prices listed in USD \$
 Ships KD = Knock Down (Assembly Required)

To specify your storage...

1. Select the Codes of the individual items you need to achieve your configuration
2. Choose Finishes where appropriate: 'top' finishes / frame color / fabric color

PRODUCT PRICING

STORAGE: MOTE SIDE BOARD

		Width (inch)			
		40" W	63" W	87" W	
Mid Board 29" High 1 Mitred Insert, 2 Single Drawers		MSS402DWC 3,968 SEE NOTE 1	-	-	Code TFL
Mid Board 29" High 1 Mitred Insert, 1 Filing Drawer		MSS40DWC 3,591 SEE NOTE 1	-	-	Code TFL
Mid Board 29" High 1 Mitred Insert, 1 Drop Down		MSS40FC 3,423 SEE NOTE 1	-	-	Code TFL
Mid Board 29" High 1 Mitred Insert, 2 Single Drawers, 1 Door		-	MSS63DR2DWC 4,424 SEE NOTE 1	-	Code TFL
Mid Board 29" High 1 Mitred Insert, 1 Filing Drawer, 1 Door		-	MSS63DRDWC 4,095 SEE NOTE 1	-	Code TFL
Mid Board 29" High 1 Mitred Insert, 1 Drop Down, 1 Door		-	MSS63DRFC 3,611 SEE NOTE 1	-	Code TFL
Mid Board 29" High 1 Mitred Insert, 2 Single Drawers, 2 Doors		-	-	MSS872DR2DWC 5,323 SEE NOTE 1	Code TFL
Mid Board 29" High 1 Mitred Insert, 1 Filing Drawer, 2 Doors		-	-	MSS872DRDWC 4,990 SEE NOTE 1	Code TFL
Mid Board 29" High 1 Mitred Insert, 1 Drop Down, 2 Doors		-	-	MSS872DRFC 4,648 SEE NOTE 1	Code TFL

Note 1: For porthole cable management add \$135

All prices listed in USD \$

Ships KD = Knock Down (Assembly Required)

Finishes & Features Available...

TFL	HD Highland Oak UM Urban Maple WH White AT Autumn WK Winter Oak SO Strata Oak CW Carini Walnut DN Denim LG Light Gray
Leg Colors	Black (Textured), Anthracite Gray, Light Gray

PRODUCT PRICING

STORAGE: MOTE HIGH BOARD

		Width (inch)			
		40" W	63" W	87" W	
Mid Board 35.5" High 1 Mitred Insert, 3 Single Drawers		MSH403DWC 4,616 SEE NOTE 1	-	-	Code TFL
Mid Board 35.5" High 1 Mitred Insert, 1 Filing Drawer, 1 Single Drawer		MSH402DWC 4,321 SEE NOTE 1	-	-	Code TFL
Mid Board 35.5" High 1 Mitred Insert, 1 Drop Down, 1 Single Drawer		MSH40FDWC 3,622 SEE NOTE 1	-	-	Code TFL
Mid Board 35.5" High 1 Mitred Insert, 3 Single Drawers, 1 Door		-	MSH63DR3DWC 5,136 SEE NOTE 1	-	Code TFL
Mid Board 35.5" High 1 Mitred Insert, 1 Filing Drawer, 1 Single Drawer, 1 Door		-	MSH63DR2DWC 4,802 SEE NOTE 1	-	Code TFL
Mid Board 35.5" High 1 Mitred Insert, 1 Drop Down, 1 Single Drawer, 1 Door		-	MSH63DRFDWC 4,600 SEE NOTE 1	-	Code TFL
Mid Board 35.5" High 1 Mitred Insert, 3 Single Drawers, 1 Door with Fridge & Wine Rack		-	MSH63DR3DWCD 7,682 SEE NOTE 1	-	Code TFL
Mid Board 35.5" High 1 Mitred Insert, 1 Single Drawer, 1 Filing Drawer, 1 Door with Fridge & Wine Rack		-	MSH63DR2DWCD 7,337 SEE NOTE 1	-	Code TFL
Mid Board 35.5" High 1 Mitred Insert, 1 Single Drawer, 1 Drop Down, 1 Door with Fridge & Wine Rack		-	MSH63DRFDWCD 7,082 SEE NOTE 1	-	Code TFL

Note 1: For porthole cable management add \$135

All prices listed in USD \$

Ships KD = Knock Down (Assembly Required)

To specify your storage...

1. Select the Codes of the individual items you need to achieve your configuration
2. Choose Finishes where appropriate: 'top' finishes / frame color / fabric color

CONFERENCE

[Back to Index](#)

STATEMENT OF LINE

STORAGE: CONFERENCE

● Available
□ Not available

Credenza
25" High



	4 Door	2 Door 3 Drawer
78" W x 19.5" D	●	●

STORAGE: CONFERENCE

CREDENZA

Pull out depth: 27.5"



Grain Direction
Grain direction side to side on horizontal panels, side to side on vertical panels, and side to side on door and drawer fronts

Storage Options
4 doors and 4 drawers (non-locking)
2 doors and 3 drawers (non-locking)

Construction
Top, base, back, divider, doors and drawer fronts 3/4" TFL
End panels 1" TFL

DIMENSIONS

19.5" Deep

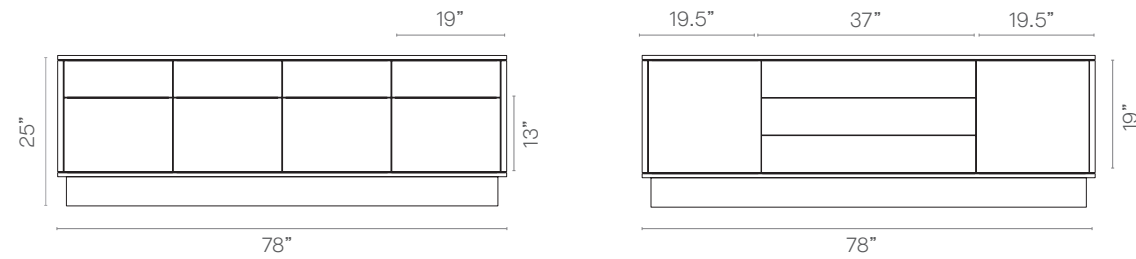

FEATURES

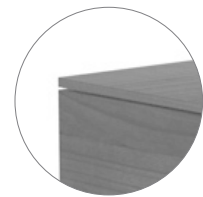

1/4" shadow gap between top and carcass and 1/4" shadow gap between base and carcass

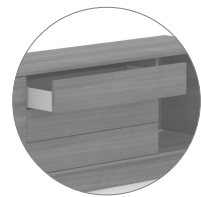

Metal sided personal drawers come complete with "Push-to-open" function

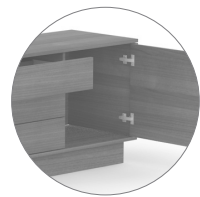

Doors also feature "Push-to-open" function

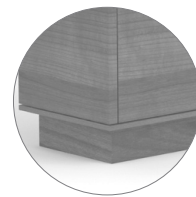

Carcass sits on an inset plinth with integrated 0.5" leveling feet

STORAGE: CONFERENCE

Conference Credenza Storage Unit

19.5" depth
78" width
4 doors, 4 drawers

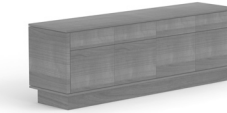

Conference Credenza Storage Unit

19.5" depth
78" width
2 doors, 3 drawers



Height (inch)		Code
25" H		TFL
SMSR20-1 2,682		TFL
SMSR20-2 2,334		TFL

All prices listed in USD \$
If Under 63": Ships Fully Assembled
If Over 63": Ships KD = Knock Down (Assembly Required)

Finishes & Features Available...

TFL | HD Highland Oak | UM Urban Maple | WH White | AT Autumn | WK Winter Oak | SO Strata Oak | CW Carini Walnut | DN Denim | LG Light Gray

WORKPLACE SUPPORT

[Back to Index](#)

STATEMENT OF LINE

STORAGE: ANCILLARY

● Available
□ Not available

AV Media Table



42" D	29" H	41" H
80.5" W	●	●

Not supplied with monitor arm and display

Tech Table



41" H	130" W	165" W
48" D	●	●

Not supplied with monitor arm and display

Coat Cupboard



24" D	39" W	78" W	117" W
62" H	●	●	●
78" H	●	●	●

STORAGE: ANCILLARY

Mobile Whiteboard
74" High

- Available
- Not available



Whiteboard



Whiteboard with Storage

24" D	74" H	74" H
50" W	●	●

Accessories



Monitor Arm



In Desk Power
(1 Power, 2 USB
Charging)

A large grid area for notes, consisting of a fine grid pattern.

STORAGE: ANCILLARY

AV MEDIA TABLE

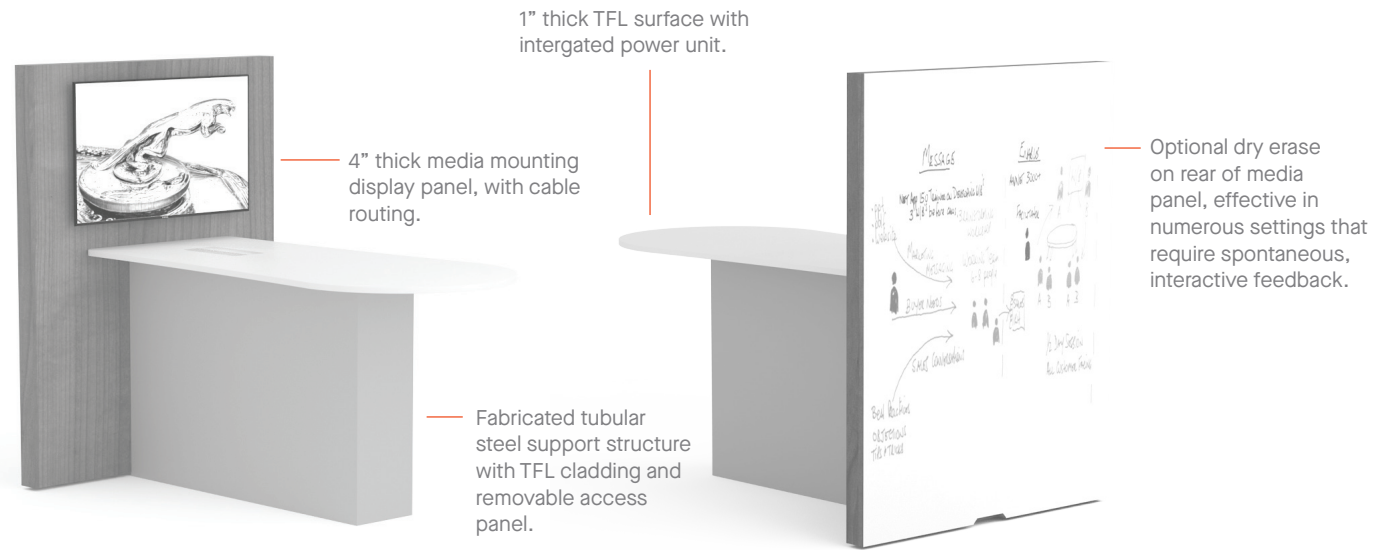

DIMENSIONS

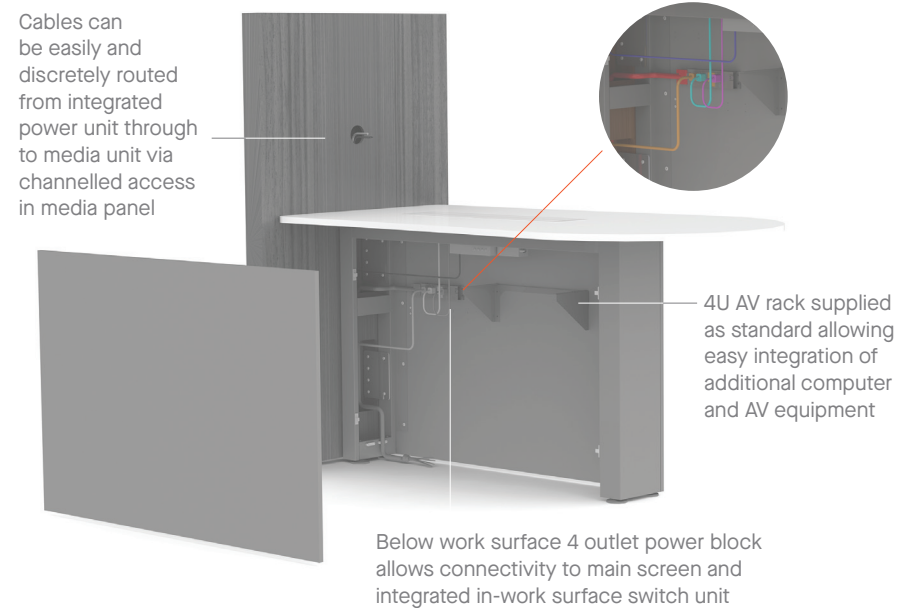
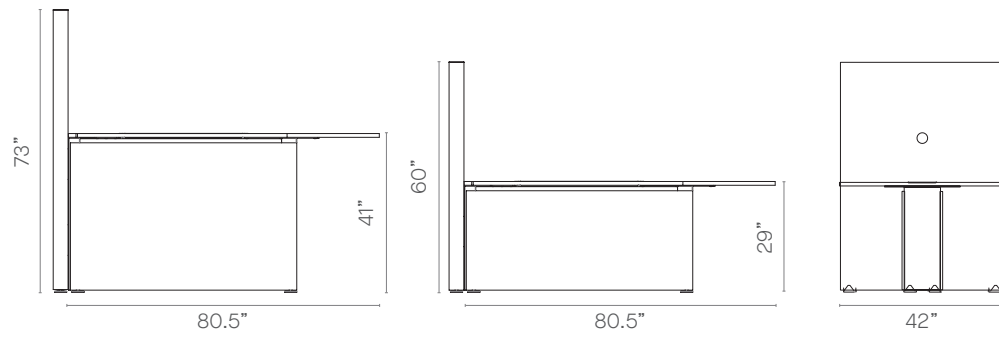

STORAGE: ANCILLARY

TECH TABLES

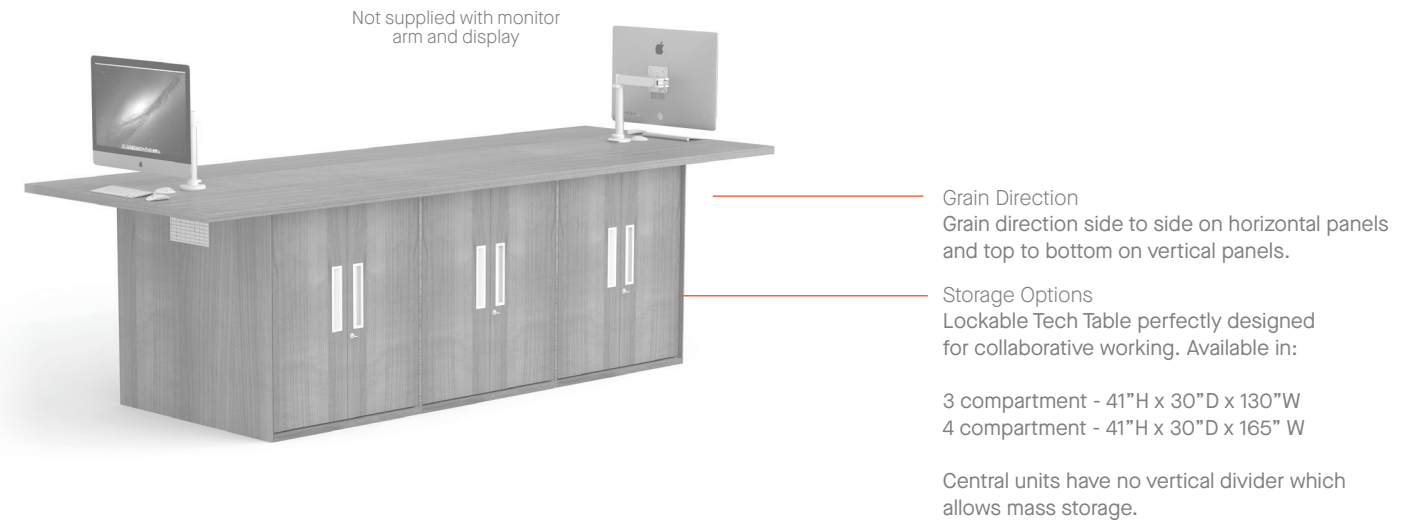

DIMENSIONS

48" Deep

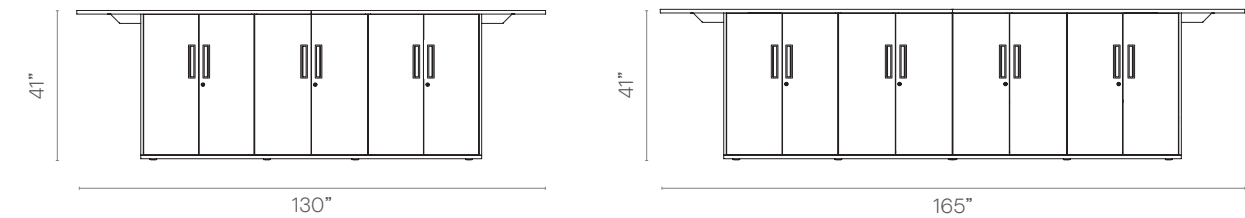

FEATURES



STORAGE: ANCILLARY

COAT CUPBOARD

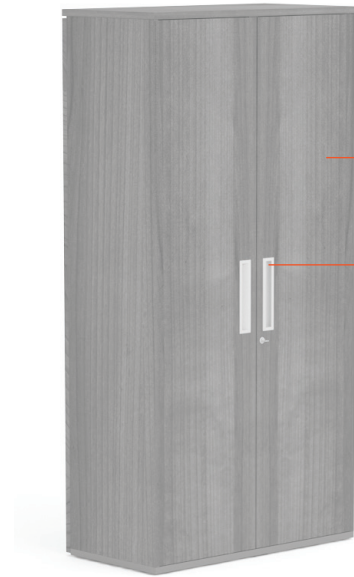

Grain Direction
Grain direction side to side on horizontal panels and top to bottom on vertical panels.

Storage Options
78" high lockable Coat Cupboard complete with storage shelf and hanging rail.
62" high lockable Coat Cupboard complete with hanging rail.

DIMENSIONS

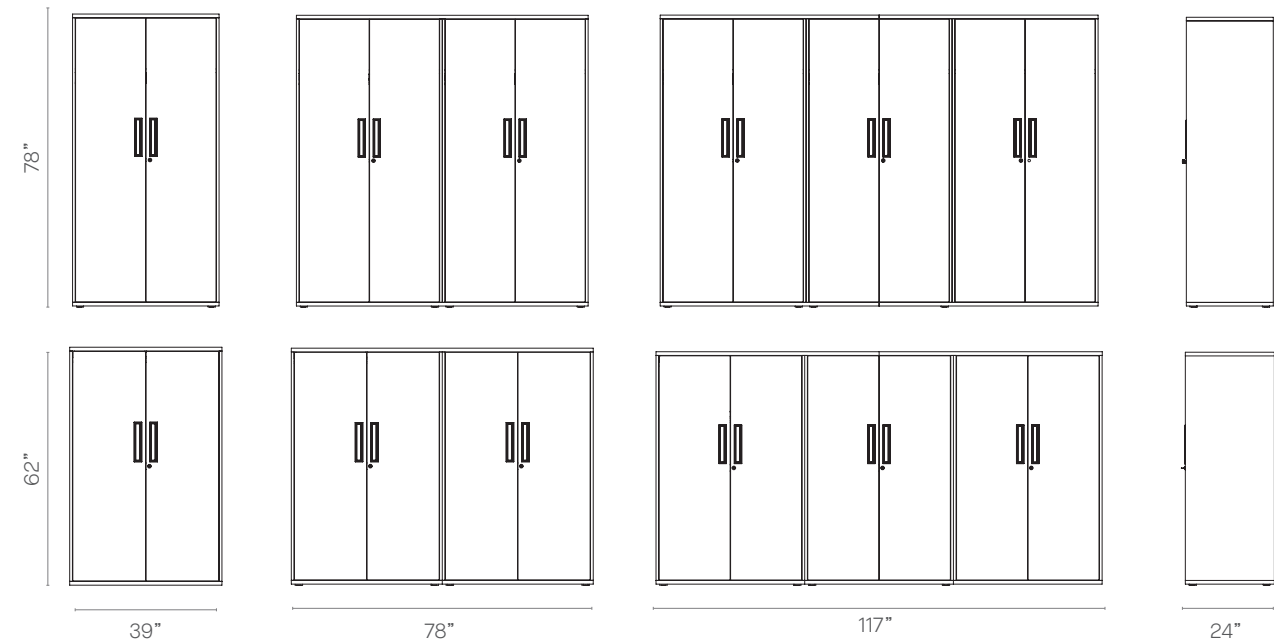

FEATURES

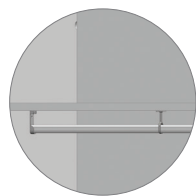

Unit comes complete with shelf for shoe and bag storage (78" only) plus hanging rail for coats and other garments.

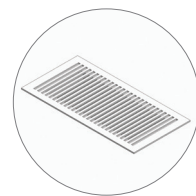

Top panel is fitted with vent to allow damp garments to air.

STORAGE: ANCILLARY

MOBILE WHITEBOARD



Dual sided whiteboard available in a magnetic and non-magnetic options.

Steel frame in a powder coated finish.

Storage Options
Shelf with 4 x pen pots or Shelf with 2 x pen pots and pull out storage drawer

DIMENSIONS

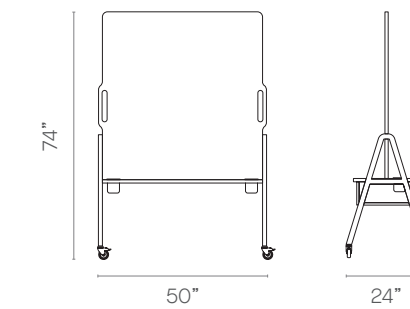

FEATURES



Pen pots are ideal for tidy placement of dry erase markers.



Tactile handles allow unit to be easily repositioned.



Lockable casters allow unit to be easily relocated and firmly held in position while in use.



Optional drawer gives additional easy access storage.



Magnetic Dry Erase board allows notes, presentations, and charts to be positioned on the board, increasing functionality.

STORAGE: AV MEDIA TABLE & TECH TABLE

29"H x 39"D AV Media Table

Dark gray frame
Black media mounting display
Indesk power/AV



41"H x 39"D AV Media Table

Dark gray frame
Black media mounting display
Indesk power/AV



41"H x 48"D Tech Table



In Desk Power
1x Power
2x USB Charging



Width (inch)		Code
80.5" W		
		TG8045M
		15,130
		15,264
		SEE NOTE 1
		TG8045H
		15,499
		15,632
		SEE NOTE 1
Width (inch)		Code
130" W	165" W	
		TT13048-KD
		6,775
		SEE NOTES 1 & 2
		TT16548-KD
		8,419
		SEE NOTES 1 & 2
		IDPTT
		334
		Code Price

Note 1: Ships knockdown and requires assembly.
Note 2: Please specify Silver, Black, or White pulls

All prices listed in USD \$
If Under 63": Ships Fully Assembled
If Over 63": Ships KD = Knock Down (Assembly Required)

STORAGE: COAT CUPBOARD

39"W x 24"D Coat Cupboard



78"W x 24"D Coat Cupboard



117"W x 24"D Coat Cupboard



Height (inch)		Code
62" H	78" H	
		CC6239-2DR
		1,584
		CC7839-2DR
		1,746
		CC6278-4DR
		2,756
		CC7878-4DR
		3,054
		CC62117-6DR
		3,952
		CC78117-6DR
		4,400
		Code TFL
		Code TFL
		Code TFL

Note 1: Please specify Silver, Black, or White pulls

All prices listed in USD \$
If Under 63": Ships Fully Assembled
If Over 63": Ships KD = Knock Down (Assembly Required)

Finishes & Features Available...

TFL HD Highland Oak | UM Urban Maple | WH White | AT Autumn | WK Winter Oak | SO Strata Oak | CW Carini Walnut | DN Denim | LG Light Gray

To specify your storage...

1. Select the Codes of the individual items you need to achieve your configuration
2. Choose Finishes where appropriate: 'top' finishes / frame color / fabric color

STORAGE: MOBILE WORKING WHITEBOARD

74"H x 24"D
Mobile Whiteboard



74"H x 24"D
Mobile Whiteboard
with Storage



Width (inch)			
50" W			
MWWB	3,021	Code	Dry Erase
	4,459		Magnetic
			Dry Erase
SEE NOTE 1			
MWWBS	4,375	Code	Dry Erase
	5,752		Magnetic
			Dry Erase
SEE NOTE 1			

Note 1: Frame available in White or Black

All prices listed in USD \$
If Under 63": Ships Fully Assembled
If Over 63": Ships KD = Knock Down (Assembly Required)

Finishes & Features Available...

TFL (1")	HD Highland Oak UM Urban Maple WH White AT Autumn WK Winter Oak SO Strata Oak CW Carini Walnut DN Denim LG Light Gray
Frame / Leg Colors	White Black

FINISHES

STORAGE FINISHES – Standard Top Finishes – TFL (Edge 69)



Carini Walnut



Autumn



Strata Oak

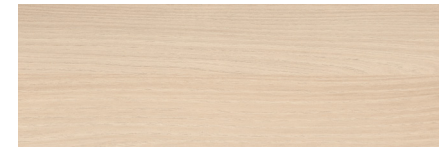

Urban Maple



Highland Oak



Winter Oak

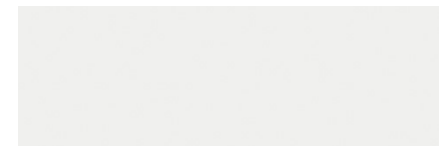

White



Light Gray



Denim

STANDARD CONSTRUCTION (UNLESS SPECIFIED)

Top, base, and shelf panels are 1" TFL with 2 mm matching laser edge band.

All other panels are 3/4" TFL with 2 mm matching laser edge band.

All units are designed to finish flush to avoid gaps when aligning units.

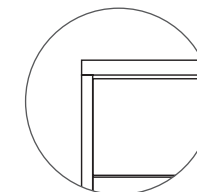
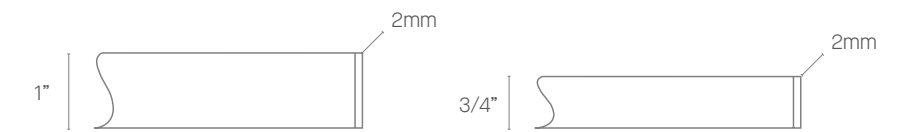

Top panels master side panels for increased strength and uninterrupted top surface.

STORAGE FINISHES

PULL FINISHES (* SELECT PRODUCTS)



White



Black

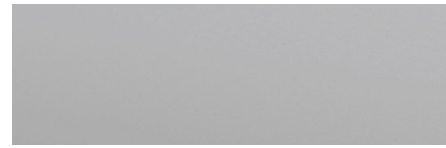

Silver

MOTE LEG FINISHES



Black (Textured)

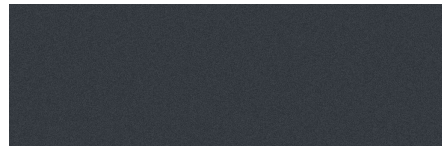

Anthracite Gray

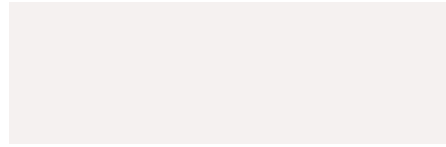

Light Gray

Concealed leveling feet, which can be accessed from inside the unit, offering 5/8" of adjustment available on:

- Under Desk Personal Storage
- Desk End Storage
- Lockers
- Desk Height
- Screen Height
- Space Divider
- Hang On
- Tech Table
- Coat Cupboard

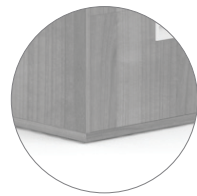

Cast Aluminum pulls in powder coated finish complete with lock, available on:

- Under Desk Personal Storage
- Desk End Storage - sliding door
- Lockers
- Desk Height
- Screen Height
- Space Divider
- Hang On
- Tech Table
- Coat Cupboard

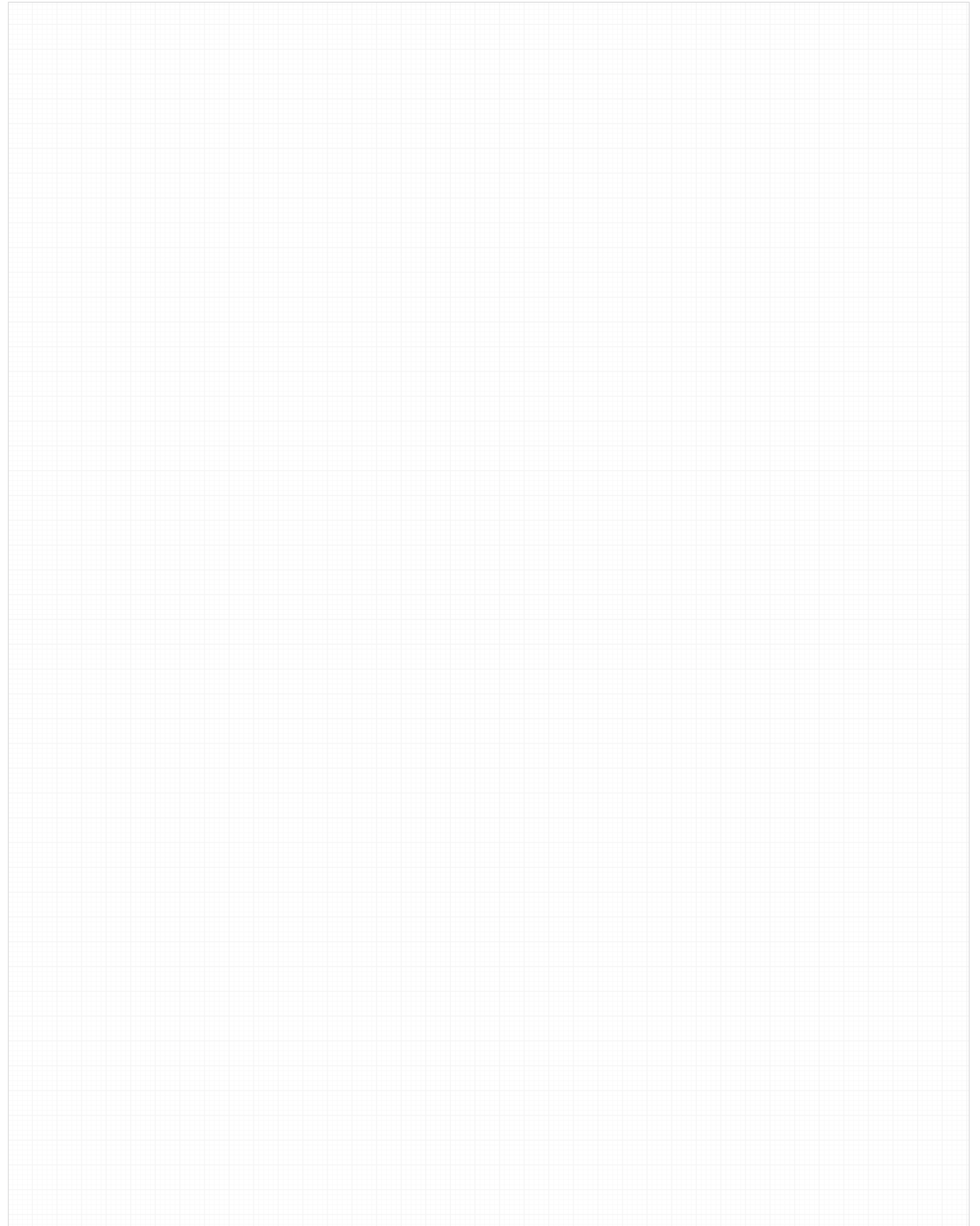
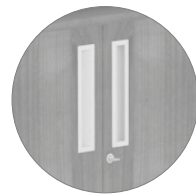

STORAGE FINISHES

PULL FINISHES (* SELECT PRODUCTS)



White



Black

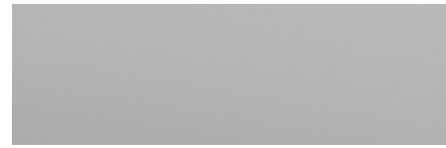

Silver

MOTE LEG FINISHES



Black (Textured)

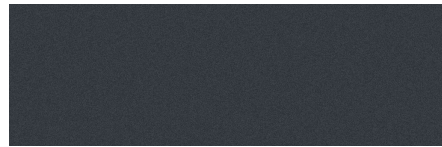

Anthracite Gray

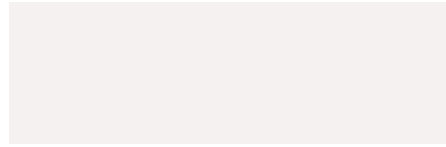

Light Gray

Concealed leveling feet, which can be accessed from inside the unit, offering 5/8" of adjustment available on:

- Under Desk Personal Storage
- Desk End Storage
- Lockers
- Desk Height
- Screen Height
- Space Divider
- Hang On
- Tech Table
- Coat Cupboard

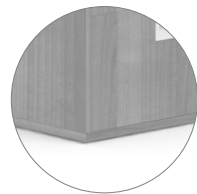

Cast Aluminum pulls in powder coated finish complete with lock, available on:

- Under Desk Personal Storage
- Desk End Storage - sliding door
- Lockers
- Desk Height
- Screen Height
- Space Divider
- Hang On
- Tech Table
- Coat Cupboard

