

SENATOR

MOTE

MOTE



MEET, RETREAT

Mote has been designed to provide a holistic solution when designing dynamic environments. Created as a complete lounge seating range, no detail is an afterthought, with every inch having been given careful consideration to eliminate dead space.

The Mote family includes sofas, ottomans, screens and accessories, each linking seamlessly to each other to create a combination of rectilinear and curvilinear forms for beautiful yet defined spaces.

WANT TO KNOW MORE?

Our literature is available to download from our resource section on our website. For training notes, you can contact usmarketing@thesenatorgroup.com or call +1 (419) 887 5806

A full range overview and the following resources are available on each product page of our website.

For quick inspiration and all the latest news, follow us on social @senator_social.



Specification Sheet



Symbols



Environmental Data



Images (High Res)

MOTE



STANDARD FEATURES (*Selected models only)

- Traditional carcass construction with multi density foam
- Fully upholstered
- Cast Aluminum frame
- Plastic glides with leveling adjustment

OPTIONAL FEATURES

- Frame fitted power units - 2x powered USB/TUF and 1x power outlet*
- Two-tone upholstery
- End arms
- Single arms - mid
- Double arms - intermediate

PERFORMANCE STANDARDS

- SCS-EC10.3-2014 v. 4.0 Indoor Advantage Gold



MATERIAL CONTENT

Components are constructed of the following

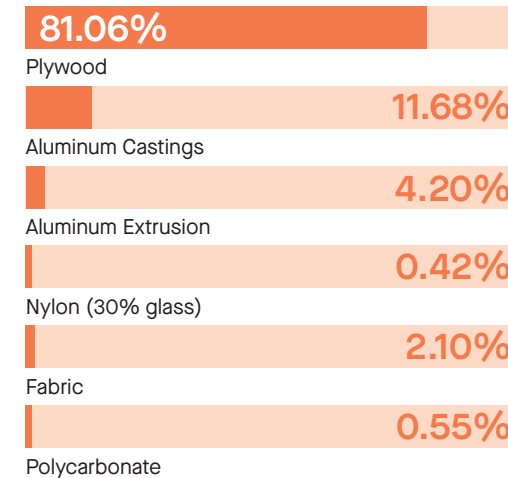

RECYCLED CONTENT

Contains up to 17.00% of Recycled Material

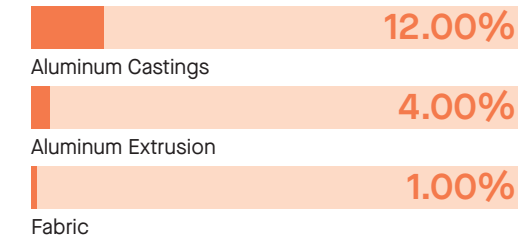

RECYCLABILITY

The range is 99% recyclable

99%

For more detail please refer to individual EPA sheets.



DESIGN

Senator

Our team of talented in house designers are responsible for creating elegant, innovative furniture designs which not only look beautiful, but minimize the impact on the world around us.

They come from all over the world, but are based in our Design Center located in a quiet Lancashire village just outside the Ribble Valley. Our dedicated facility is over three floors which include studios, a materials test center and prototyping lab.

MOTE

DIMENSIONS

OH-Overall Height OD-Overall Depth OW-Overall Width AH-Arm Height BH-Back Height SH-Seat Height SW-Seat Width SD-Seat Depth

OTTOMAN

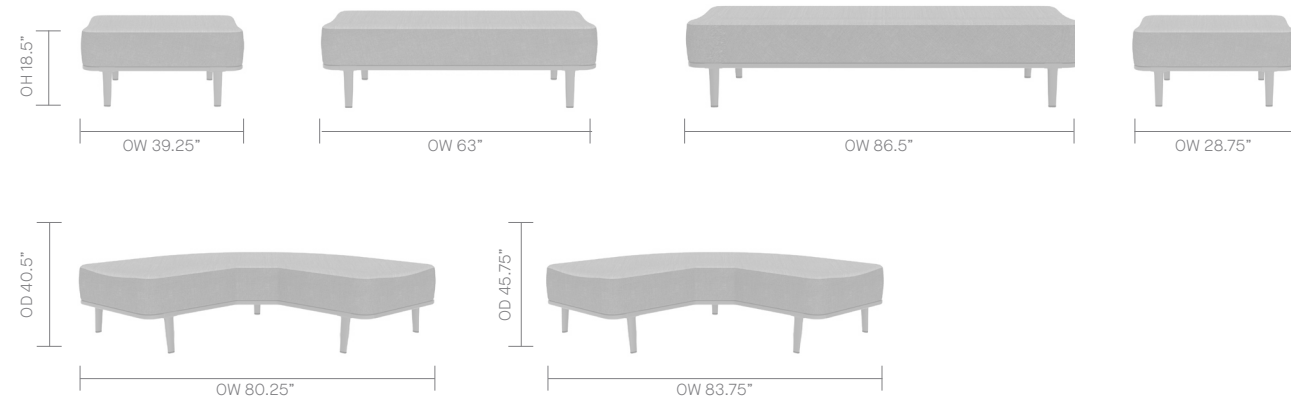

SOFA

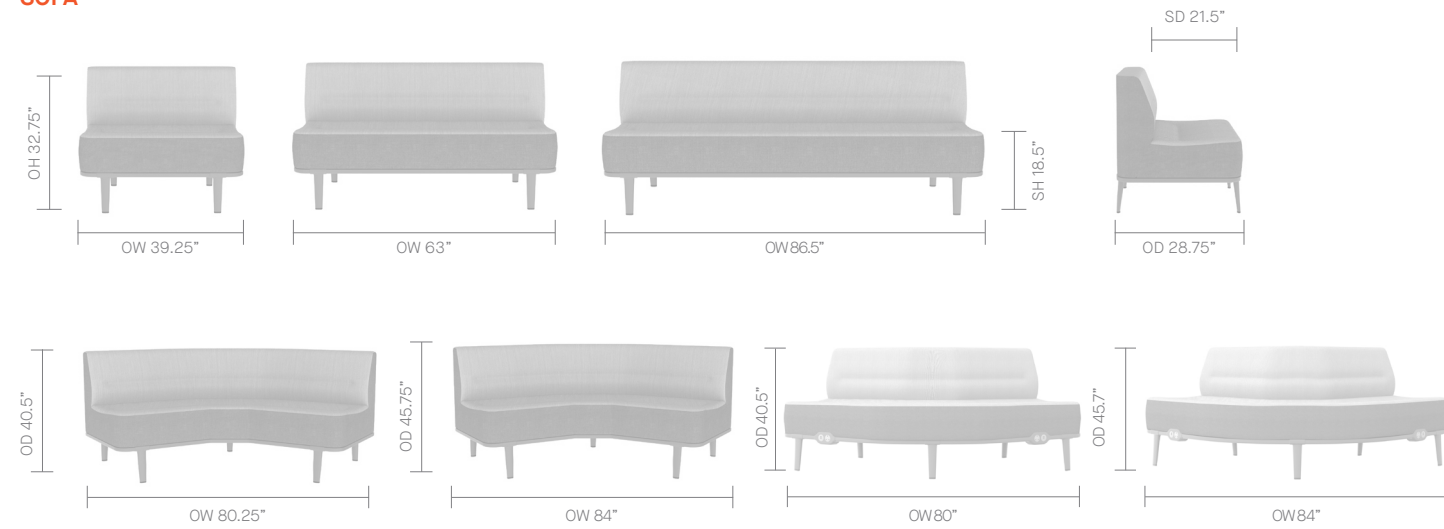

CANOPY

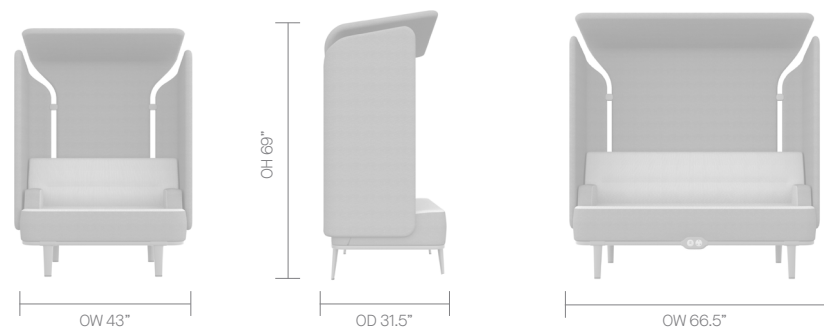

MOTE

DIMENSIONS

OH-Overall Height OD-Overall Depth OW-Overall Width AH-Arm Height BH-Back Height SH-Seat Height SW-Seat Width SD-Seat Depth

REAR SCREEN

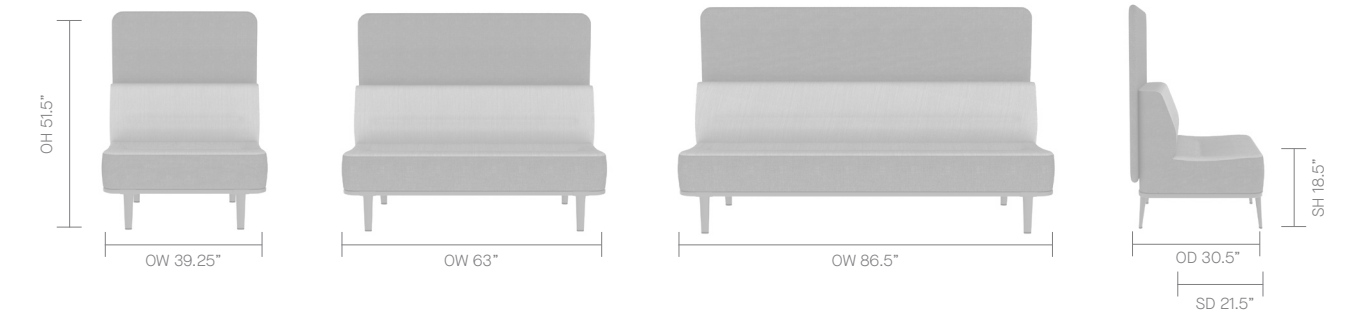

REAR & SIDE SCREEN



MOTE

DIMENSIONS

OH-Overall Height OD-Overall Depth OW-Overall Width AH-Arm Height BH-Back Height SH-Seat Height SW-Seat Width SD-Seat Depth

RETREAT

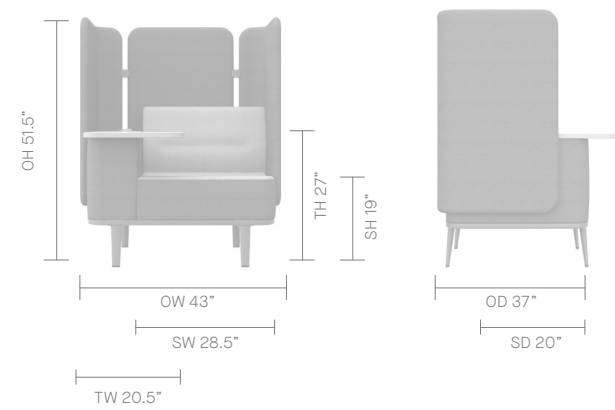

BRIDGING SCREEN

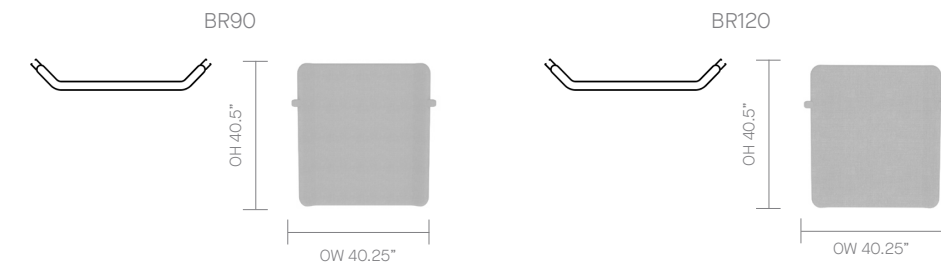

FOOTSTOOL

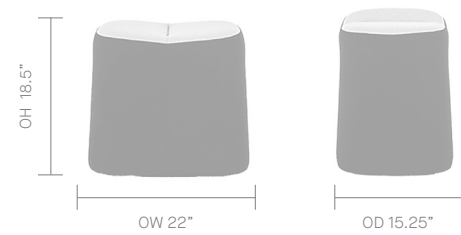

90° TWO LINK UNIT

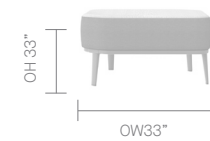

MOTE

FINISH OPTIONS

- Cast Aluminum frame available in Black, Anthracite Gray or Light Gray

FRAME FINISHES



TFL FINISHES

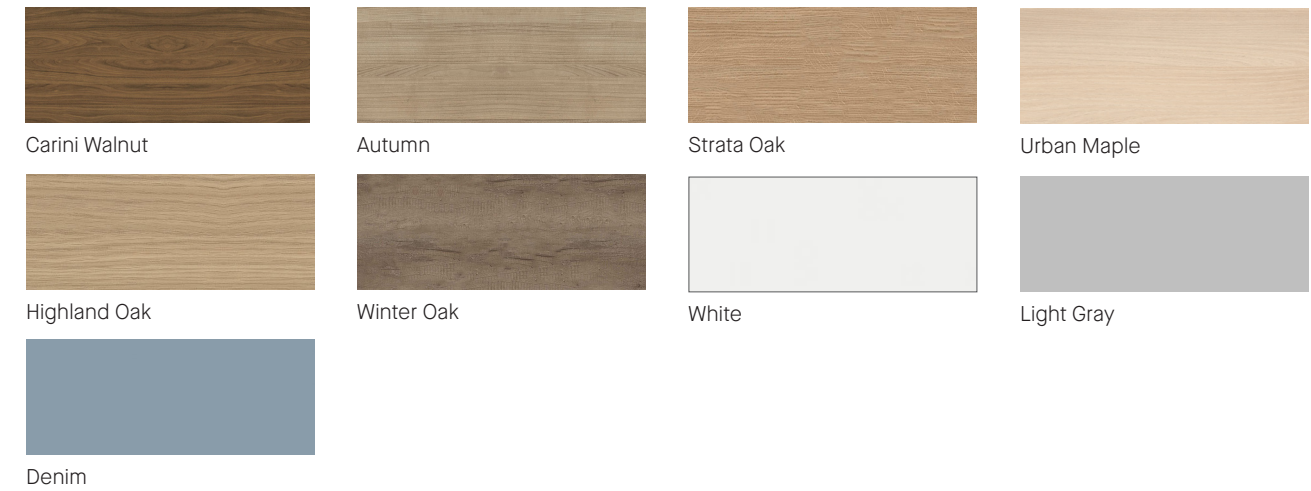

Color images above are for reference only. Please verify with actual color sample.

MOTE

- Standard feature
- Not available
- Optional feature





	MTEOT01	MTEOT02	MTEOT03	MTEOT90	MTEOT120	MTEOT2WC
	Single Seat Ottoman	Two Seat Ottoman	Three Seat Ottoman	90° Ottoman	120° Ottoman	90° Two way link unit
Weight	□	□	□	□	□	□
Ottoman - Traditional carcass construction with multi density foam	●	●	●	●	●	●
Fully upholstered	●	●	●	●	●	●
Cast aluminum legs finished in Black textured powder coat *	●	●	●	●	●	●
Plastic glides with leveling adjustment	●	●	●	●	●	●
Cast aluminum frame available in Anthracite Gray or Light Gray	+\$0	+\$0	+\$0	+\$0	+\$0	+\$0
End arms	□	□	□	□	□	□
Single arm - mid	□	+\$234	□	□	□	□
Double arms - intermediate	□	□	+\$396	□	□	□
1 x Front facing, frame integrated power unit - 2 x powered USB and 1 x power outlet	+\$750	+\$750	□	+\$750	+\$750	□
2 x Front facing, frame integrated power unit - 2 x powered USB and 1 x power outlet	□	□	+\$1,400	□	□	□
1 x Rear facing, frame integrated power unit - 2 x powered USB and 1 x power outlet	+\$750	+\$750	□	□	□	□
2 x Rear facing, frame integrated power unit - 2 x powered USB and 1 x power outlet	□	□	+\$1,400	+\$1,400	+\$1,400	□
Two-tone upholstery (use the price for the highest grade of the fabric selected)	+\$100	+\$150	+\$150	+\$150	+\$150	+\$100

Please note that Mote is not suitable for upholstery in leather.
 All fabrics will be railroad stitched due to the size of the product.
 * Click here to see available Finishes.
 * Click here to see available Fabrics.

Ships Fully Assembled

Linking Kit	
MTE-LINK Optional linking kit available to link two adjacent Mote units together	85

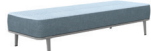
MOTE

Fabric Grade	0	1	2	3	4	5	6	7	8	9	A	B	COM	COL	
MTEOT01 Single seat ottoman	-	1,895	1,979	2,075	2,197	2,317	2,437	2,558	2,798	3,280	-	-	1,895	-	
													4.5 yds		
MTEOT02 Two seat ottoman	-	2,633	2,741	2,866	3,019	3,176	3,328	3,483	3,793	4,413	-	-	2,633	-	
													6.25 yds		
MTEOT03 Three seat ottoman	-	3,342	3,480	3,635	3,831	4,027	4,222	4,420	4,811	5,595	-	-	3,342	-	
													8 yds		
MTEOT90 90° angled ottoman	-	4,328	4,484	4,662	4,886	5,110	5,334	5,556	6,003	6,896	-	-	4,328	-	
													7 yds		
MTEOT120 120° angled ottoman	-	4,436	4,616	4,822	5,082	5,337	5,596	5,852	6,369	7,399	-	-	4,436	-	
													7.25 yds		
MTEOT2WC 90° two way link unit	-	1,895	1,979	2,075	2,197	2,317	2,437	2,558	2,796	3,280	-	-	1,895	-	

A, B = Leather

COM = Customers own Material (yds)

COL = Customers own Leather (sq ft.)

All prices listed in US \$

To specify your soft seating...

1. Check the Standard Features and Finishes and select the Model you require
2. Select the Fabric Band for the fabric you are using this will give you the basic price per item
3. Select any Optional Extras or Alternative Finishes you require and add on any extra costs as shown per item
4. You now have the total cost and specification for Your Item

When ordering, please ensure that you send us all this information, so we can correctly fulfil your requirements.

WORKSPACES

MOTE

- Standard feature
- Not available
- Optional feature

	MTESF01 Single Seat Sofa	MTESF02 Two Seat Sofa	MTESF03 Three Seat Sofa	MTESF90 90° Sofa	MTESF120 120° Sofa	MTESF240 90° Sofa reversed	MTESF270 120° Sofa reversed
Weight	□	□	□	□	□	□	□
Sofa - Traditional carcass construction with multi-density foam	●	●	●	●	●	●	●
Fully upholstered	●	●	●	●	●	●	●
Cast aluminum legs finished in Black textured powder coat	●	●	●	●	●	●	●
Plastic glides with leveling adjustment	●	●	●	●	●	●	●

Cast aluminum frame available in Anthracite Gray or Light Gray	+ \$0	+ \$0	+ \$0	+ \$0	+ \$0	+ \$0	+ \$0
End arms	+ \$396	+ \$396	+ \$396	□	□	□	□
Single arm - mid	□	+ \$236	□	□	□	□	□
Double arms - intermediate	□	□	+ \$396	□	□	□	□
1 x Front facing, frame integrated power unit - 2 x powered USB and 1 x power outlet	+ \$750	+ \$750	□	+ \$750	+ \$750	□	□
2 x Front facing, frame integrated power unit - 2 x powered USB and 1 x power outlet	□	□	+ \$1,400	□	□	+ \$1,400	+ \$1,400
1 x Rear facing, frame integrated power unit - 2 x powered USB and 1 x power outlet	+ \$750	+ \$750	□	□	□	+ \$750	+ \$750
2 x Rear facing, frame integrated power unit - 2 x powered USB and 1 x power outlet	□	□	+ \$1,400	+ \$1,400	+ \$1,400	□	□
Two-tone upholstery (use the price for the highest grade of the fabric selected)	+ \$100	+ \$150	+ \$150	+ \$150	+ \$150	+ \$150	+ \$150

Please note that Mote is not suitable for upholstery in leather.
 All fabrics will be railroad stitched due to the size of the product.
 * Click here to see available Finishes.
 * Click here to see available Fabrics.

Ships Fully Assembled

Linking Kit

MTE-LINK Optional linking kit available to link two adjacent Mote units together	85
--	----

WORKSPACES

MOTE

Fabric Grade	0	1	2	3	4	5	6	7	8	9	A	B	COM	COL	
MTESF01 Single seat sofa	-	2,611	2,715	2,835	2,989	3,139	3,289	3,442	3,742	4,348	-	-	2,611 5.5 yds	-	
MTESF02 Two seat sofa	-	3,585	3,735	3,904	4,117	4,329	4,543	4,755	5,782	6,035	-	-	3,585 8.25 yds	-	
MTESF03 Three seat sofa	-	4,644	4,838	5,057	5,331	5,607	5,883	6,157	6,706	7,806	-	-	4,644 11 yds	-	
MTESF90 90° angled sofa	-	6,581	6,822	7,097	7,441	7,783	8,128	8,471	9,158	10,532	-	-	6,581 9.5 yds	-	
MTESF120 120° angled sofa	-	6,757	7,023	7,326	7,703	8,080	8,458	8,837	9,593	11,103	-	-	6,757 8.25 yds	-	
MTESF240 90° angled sofa reversed	-	6,581	6,822	7,097	7,441	7,783	8,128	8,471	9,158	10,532	-	-	6,581 9.5 yds	-	
MTESF270 120° angled sofa reversed	-	6,757	7,023	7,326	7,703	8,080	8,458	8,837	9,593	11,103	-	-	6,757 8.25 yds	-	

A, B = Leather

COM = Customers own Material (yds)

COL = Customers own Leather (sq ft.)

All prices listed in US \$

To specify your soft seating...

1. Check the Standard Features and Finishes and select the Model you require
2. Select the Fabric Band for the fabric you are using this will give you the basic price per item
3. Select any Optional Extras or Alternative Finishes you require and add on any extra costs as shown per item
4. You now have the total cost and specification for Your Item

When ordering, please ensure that you send us all this information, so we can correctly fulfil your requirements.

MOTE

- Standard feature
- ☐ Not available
- Optional feature

	MTEBSS01 Single Seat Sofa With Rear Screen	MTEBSS02 Two Seat Sofa With Rear Screen	MTEBSS03 Three Seat Sofa With Rear Screen	MTEBSS90 90° Angled Sofa With Rear Screen	MTEBSS120 120° Rear Screen
Weight	☐	☐	☐	☐	☐
Sofa - Traditional carcass construction with multi density foam	●	●	●	●	●
Rear screens	●	●	●	●	●
Fully upholstered	●	●	●	●	●
Cast aluminum legs finished in Black textured powder coat *	●	●	●	●	●
Plastic glides with leveling adjustment	●	●	●	●	●
Cast aluminum frame available in Anthracite Gray or Light Gray	+\$0	+\$0	+\$0	+\$0	+\$0
End arms	+\$396	+\$396	+\$396	☐	☐
Single arm - mid	☐	+\$234	☐	☐	☐
Double arms - intermediate	☐	☐	+\$396	☐	☐
1 x Front facing, frame integrated power unit - 2 x powered USB and 1 x power outlet	+\$750	+\$750	☐	+\$750	+\$750
2 x Front facing, frame integrated power unit - 2 x powered USB and 1 x power outlet	☐	☐	+\$1,400	☐	☐
1 x Rear facing, frame integrated power unit - 2 x powered USB and 1 x power outlet	+\$750	+\$750	☐	☐	☐
2 x Rear facing, frame integrated power unit - 2 x powered USB and 1 x power outlet	☐	☐	+\$1,400	+\$1,400	+\$1,400
Two-tone upholstery (use the price for the highest grade of the fabric selected)	+\$100	+\$150	+\$150	+\$150	+\$150

Please note that Mote is not suitable for upholstery in leather.

All fabrics will be railroad stitched due to the size of the product.

* Click here to see available Finishes.

* Click here to see available Fabrics.

Ships Fully Assembled

Linking Kit

<p>MTE-LINK</p> <p>• Optional linking kit available to link two adjacent Mote units together</p>	85
---	----

MOTE

Fabric Grade	0	1	2	3	4	5	6	7	8	9	A	B	COM	COL
<p>MTEBSS01</p> <p>• Single seat sofa</p> <p>• Rear Screen</p>	-	3,533	3,689	3,870	4,090	4,314	4,538	4,762	5,209	6,100	-	-	3,533	-
													8.75 yds	
<p>MTEBSS02</p> <p>• Two seat sofa</p> <p>• Rear Screen</p>	-	4,776	5,005	5,265	5,592	5,918	6,244	6,570	7,224	8,528	-	-	4,776	-
													13 yds	
<p>MTEBSS03</p> <p>• Three seat sofa</p> <p>• Rear Screen</p>	-	6,029	6,330	6,673	7,102	7,531	7,961	8,392	9,249	10,967	-	-	6,029	-
													17.75 yds	
<p>MTEBSS90</p> <p>• 90° angled sofa</p> <p>• Rear screen</p>	-	8,842	9,227	9,667	10,217	10,768	11,317	11,878	12,964	15,163	-	-	8,842	-
													18.25 yds	
<p>MTEBSS120</p> <p>• 120° angled sofa</p> <p>• Rear screen</p>	-	8,993	9,400	9,869	10,451	11,035	11,621	12,203	13,373	15,709	-	-	8,993	-
													17 yds	

A, B = Leather

COM = Customers own Material (yds)

COL = Customers own Leather (sq ft.)

All prices listed in US \$



To specify your soft seating...

1. Check the Standard Features and Finishes and select the Model you require
2. Select the Fabric Band for the fabric you are using this will give you the basic price per item
3. Select any Optional Extras or Alternative Finishes you require and add on any extra costs as shown per item
4. You now have the total cost and specification for Your Item

When ordering, please ensure that you send us all this information, so we can correctly fulfil your requirements.

MOTE

- Standard feature
- Not available
- Optional feature

	MTEBSF01	MTEBSF02	MTEBSF03	MTEBCSLO1	MTEBCSR01
	Single seat sofa with rear and side screens	Two seat sofa with rear and side screens	Three seat sofa with rear and side screens	Single seat sofa with rear and left hand corner screen	Single seat sofa with rear and right hand corner screen
Weight	□	□	□	□	□
Sofa - Traditional carcass construction with multi density foam	●	●	●	●	●
Rear and side screens	●	●	●	□	□
Rear and left hand corner screen with arm	□	□	□	●	□
Rear and right hand corner screen with arm	□	□	□	□	●
Fully upholstered	●	●	●	●	●
End arms	●	●	●	□	□
Cast aluminum legs finished in Black textured powder coat *	●	●	●	●	●
Plastic glides with leveling adjustment	●	●	●	●	●
Cast aluminum frame available in Anthracite Gray or Light Gray	+ \$0	+ \$0	+ \$0	+ \$0	+ \$0
Single arm - mid	□	+ \$234	□	□	□
Double arms - intermediate	□	□	+ \$396	□	□
2 x Bag/Coat hooks finished in satin chrome fitted to the outer left hand screen	□	□	□	+ \$130	□
2 x Bag/Coat hooks finished in satin chrome fitted to the outer right hand screen	□	□	□	□	+ \$130
4 x Bag/Coat hooks finished in satin chrome fitted to left and right hand outer screens	+ \$260	+ \$260	+ \$260	□	□
1 x Front facing, frame integrated power unit - 2 x powered USB and 1 x power outlet	+ \$750	+ \$750	□	+ \$750	+ \$750
2 x Front facing, frame integrated power unit - 2 x powered USB and 1 x power outlet	□	□	+ \$1,400	□	□
1 x Rear facing, frame integrated power unit - 2 x powered USB and 1 x power outlet	+ \$750	+ \$750	□	+ \$750	+ \$750
2 x Rear facing, frame integrated power unit - 2 x powered USB and 1 x power outlet	□	□	+ \$1,400	□	□
Two-tone upholstery (use the price for the highest grade of the fabric selected)	+ \$150	+ \$150	+ \$150	+ \$150	+ \$150

Please note that Mote is not suitable for upholstery in leather.

Ships Fully Assembled

All fabrics will be railroad stitched due to the size of the product.

* Click here to see available Finishes.

* Click here to see available Fabrics.

Linking Kit	
MTE-LINK · Optional linking kit available to link two adjacent Mote units together	85

MOTE

Fabric Grade	0	1	2	3	4	5	6	7	8	9	A	B	COM	COL	
MTEBSF01 · Single seat sofa · Rear and side screens	-	5,522	5,745	6,002	6,321	6,639	6,959	7,277	7,919	9,196	-	-	5,522	-	
													11.75 yds		
MTEBSF02 · Two seat sofa · Rear and side screens	-	6,857	7,153	7,491	7,912	8,337	8,758	9,181	10,025	11,716	-	-	6,857	-	
													16.25 yds		
MTEBSF03 · Three seat sofa · Rear and side screens	-	8,132	8,505	8,932	9,463	9,996	10,530	11,062	12,127	14,256	-	-	8,132	-	
													20.75 yds		
MTEBCSLO1 · Single seat sofa · Rear and left hand corner screen	-	4,681	4,878	5,102	5,385	5,667	5,959	6,231	6,793	7,920	-	-	4,681	-	
													10.5 yds		
MTEBCSR01 · Single seat sofa · Rear and right hand corner screen	-	4,681	4,878	5,102	5,385	5,667	5,959	6,231	6,793	7,920	-	-	4,681	-	
													10.5 yds		

A, B = Leather

COM = Customers own Material (yds)

COL = Customers own Leather (sq ft.)

All prices listed in US \$

To specify your soft seating...

1. Check the Standard Features and Finishes and select the Model you require
2. Select the Fabric Band for the fabric you are using this will give you the basic price per item
3. Select any Optional Extras or Alternative Finishes you require and add on any extra costs as shown per item
4. You now have the total cost and specification for Your Item

When ordering, please ensure that you send us all this information, so we can correctly fulfil your requirements.

WORKSPACES

MOTE

- Standard feature
- Not available
- Optional feature

	MTEBSF01SP Single seat with storage	MTEBSF10C Single seat sofa Canopy	MTEBSF10CSP Single seat with storage Canopy	MTEBSF20C Double Seat with canopy	MTE-FST Footstool
Weight	□	□	□	□	□
Sofa - Traditional carcass construction with multi density foam	●	●	●	●	●
Fully upholstered	●	●	●	●	●
Cast Aluminum legs and Aluminum perimeter frame finished in Black textured powder coat*	●	●	●	●	□
Plastic glides with levelling adjustment	●	●	●	●	□
Plastic glides	□	□	□	□	●
Back and side screens with cast Aluminum linking brackets in black powder coat	●	●	●	●	□
Hinged worksurface (RH) with incorporated 1 x power outlet, USB charging with 5 foot power cable - White	●	□	●	□	□
1" TFL top with a matching edge profile, available in Winter Oak, Strata Oak, Urban Maple, Highland Oak, Carini Walnut, Autumn, and White	●	□	●	□	□
End arms	□	●	□	●	□
Cast aluminum frame available in Anthracite Gray or Light Gray	+ \$0	+ \$0	+ \$0	+ \$0	+ \$0
Single arm - mid	-	-	-	+ \$234	-
2 x Bag/Coat hooks finished in Satin Chrome fitted to left or right hand outer screens	-	-	-	-	-
4 x Bag/Coat hooks finished in Satin Chrome fitted to left or right hand outer screens	-	-	-	-	-
1 x Front facing, frame integrated power unit - 2 x powered USB and 1 x power outlet	-	+ \$750	-	+ \$750	-
1 x Rear facing, frame integrated power unit - 2 x powered USB and 1 x power outlet	-	-	-	-	-
Two-tone upholstery (use the price for the highest grade of the fabric selected)	+ \$150	+ \$150	+ \$150	+ \$150	+ \$50
Felt glides	-	-	-	-	+ \$25

Please note that Mote is not suitable for upholstery in leather.

All fabrics will be railroad stitched due to the size of the product.

* Click here to see available Finishes.

* Click here to see available Fabrics.

Ships Fully Assembled

WORKSPACES

MOTE

Fabric Grade	0	1	2	3	4	5	6	7	8	9	A	B	COM	COL
MTE-BSF01SP • Single seat sofa • Storage • Rear and side screens	-	7,652	7,954	8,300	8,732	9,165	9,598	10,030	10,895	12,625	-	-	7,652	-
													11.75 yds	
MTE-BSF10C • Single seat sofa • Canopy • Side Screens • End Arms	-	7,307	7,554	7,835	8,188	8,541	8,892	9,246	9,949	11,360	-	-	7,307	-
													11.0 yds	
MTE-BSF10CSP • Single seat sofa • Canopy • Side Screens • Lift Up Table Storage	-	8,915	9,238	9,609	10,069	10,533	10,996	11,457	12,384	14,233	-	-	8,915	-
													14.25 yds	
MTE-BSF20C • Two seat sofa • Canopy • Side Screens • End Arms	-	8,835	9,341	9,920	10,641	11,363	12,086	12,809	14,254	17,142	-	-	8,835	-
													18.0 yds	
MTE-FST • Footstool	-	891	917	947	985	1,022	1,061	1,098	1,173	1,325	-	-	891	-
													2.25 yds	

A, B = Leather

COM = Customers own Material (yds)

COL = Customers own Leather (sq ft.)

All prices listed in US \$

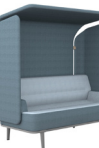

To specify your soft seating...

1. Check the Standard Features and Finishes and select the Model you require
2. Select the Fabric Band for the fabric you are using this will give you the basic price per item
3. Select any Optional Extras or Alternative Finishes you require and add on any extra costs as shown per item
4. You now have the total cost and specification for Your Item

When ordering, please ensure that you send us all this information, so we can correctly fulfil your requirements.

WORKSPACES

MOTE

- Standard feature
- Not available
- Optional feature

	MTEBR90 90° Bridging Screen	MTEBR120 120° Bridging Screen	MTEMED01 Media Panel	MTEMEDTB11 Two Seat Table	MTEMEDTB12 Four / Six Seat Table
Weight	□	□	□	□	□
Fully upholstered	●	●	●	□	□
Screen attachment brackets in Black *	●	●	●	□	□
1" TFL top with a clear edge profile, available in White TFL *	□	□	□	●	●
Fully upholstered table support in fabric matching bridging screen	□	□	□	●	●
Table support base plate finished in Black textured powder coat *	□	□	□	●	●
Plastic glides	□	□	□	●	●
Integral vertical cable management - cable exit point below table	□	□	+\$100	□	□
Integral vertical cable management - cable exit point above table	□	□	+\$100	□	□
Table edge profile can be stained in Solid Black, Espresso or Solid White	□	□	□	+\$30	+\$30
Table support base plate available in Anthracite Gray or Light Gray	□	□	□	+\$0	+\$0
TFL table top available in: Highland Oak, Urban Maple, White, Autumn, Winter Oak, Strata Oak, Carini Walnut, Denim, Light Gray	□	□	□	+\$0	+\$0

Accessories

MTE-WBF Magnetic dry whiteboard - front facing	295
MTE-WBR Magnetic dry whiteboard - rear facing	295



Ships Fully Assembled

Please note that Mote is not suitable for upholstery in leather.
 All fabrics will be railroad stitched due to the size of the product.
 * Click here to see available Finishes.
 * Click here to see available Fabrics.

WORKSPACES

MOTE

Fabric Grade	0	1	2	3	4	5	6	7	8	9	A	B	COM	COL
MTEBR90 · 90° bridging screen	-	1,260	1,324	1,394	1,484	1,573	1,661	1,753	1,931	2,287	-	-	1,260	-
													3.5 yds	
MTEBR120 · 120° bridging screen	-	1,260	1,324	1,394	1,484	1,573	1,661	1,753	1,931	2,287	-	-	1,260	-
													3.5 yds	
MTEMED01 · Media panel	-	1,480	1,543	1,614	1,705	1,792	1,882	1,971	2,148	2,508	-	-	1,480	-
													3.5 yds	

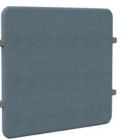

	0	1	2	3	4	5	6	7	8	9	A	B	COM	COL
MTE-MEDTB11 · Two seat table · TFL table top · Edge 44	-	1,743	1,790	1,842	1,909	1,974	2,041	2,106	2,239	2,502	-	-	1,743	-
													2.25 yds	
MTE-MEDTB12 · Four / six seat table · TFL table top · Edge 44	-	1,788	1,858	1,937	2,038	2,138	2,239	2,338	2,538	2,939	-	-	1,788	-
													3.25 yds	



A, B = Leather
 COM = Customers own Material (yds)
 COL = Customers own Leather (sq ft.)
 All prices listed in US \$

To specify your soft seating...

1. Check the Standard Features and Finishes and select the Model you require
2. Select the Fabric Band for the fabric you are using this will give you the basic price per item
3. Select any Optional Extras or Alternative Finishes you require and add on any extra costs as shown per item
4. You now have the total cost and specification for Your Item

When ordering, please ensure that you send us all this information, so we can correctly fulfil your requirements.

MOTE STORAGE

STORAGE: MOTE

● Available
 □ Not available

Mote Low Board Storage
 23" High

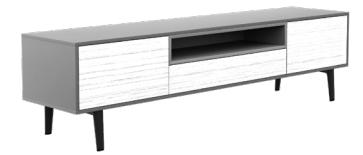

20" D	1 Single Drawer 1 Mitred insert 1 Door	1 Single Drawer 1 Mitred insert 2 Door
63" W	●	-
87" W	-	●

STATEMENT OF LINE

STORAGE: MOTE

● Available
□ Not available

Mote Side Board Storage
29" High



20" D	2 Single Drawers 1 Mitred Insert	1 Filing Drawer 1 Mitred insert	1 Drop Down 1 Mitred insert
40" W	●	●	●



20" D	2 Single Drawers 1 Mitred Insert 1 Door	1 Filing Drawer 1 Mitred insert 1 Door	1 Drop Down 1 Mitred insert 1 Door
63" W	●	●	●



20" D	2 Single Drawers 1 Mitred Insert 2 Doors	1 Filing Drawer 1 Mitred insert 2 Doors	1 Drop Down 1 Mitred insert 2 Doors
87" W	●	●	●

STATEMENT OF LINE

STORAGE: MOTE

● Available
□ Not available

Mote High Board Storage
35.5" High



20" D	3 Single Drawers 1 Mitred Insert	1 Filing Drawer 1 Mitred insert 1 Single Drawer	1 Drop Down 1 Mitred insert 1 Single Drawer
40" W	●	●	●



20" D	3 Single Drawers 1 Mitred Insert 1 Door	1 Filing Drawer 1 Mitred insert 1 Single Drawer 1 Door	1 Drop Down 1 Mitred insert 1 Single Drawer 1 Door
63" W	●	●	●



20" D	3 Single Drawers 1 Mitred Insert 1 Door with fridge & wine rack	1 Filing Drawer 1 Mitred insert 1 Single Drawer 1 Door with fridge & wine rack	1 Drop Down 1 Mitred insert 1 Single Drawer 1 Door with fridge & wine rack
63" W	●	●	●

STORAGE: MOTE

MOTE STORAGE LOW BOARD



Storage Combinations – mitred insert as standard
 63" combination options
 1 x single drawer, 1 x door
 87" combination options
 1 x single drawer, 2 x door

Grain Direction
 Grain direction side to side on all panels.

DIMENSIONS

20" Deep

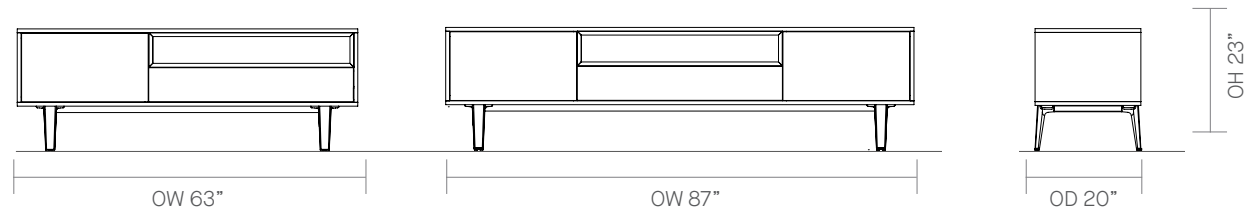

Optional cable management

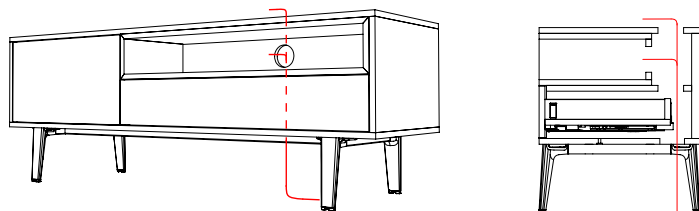

STORAGE: MOTE

MOTE STORAGE SIDE BOARD

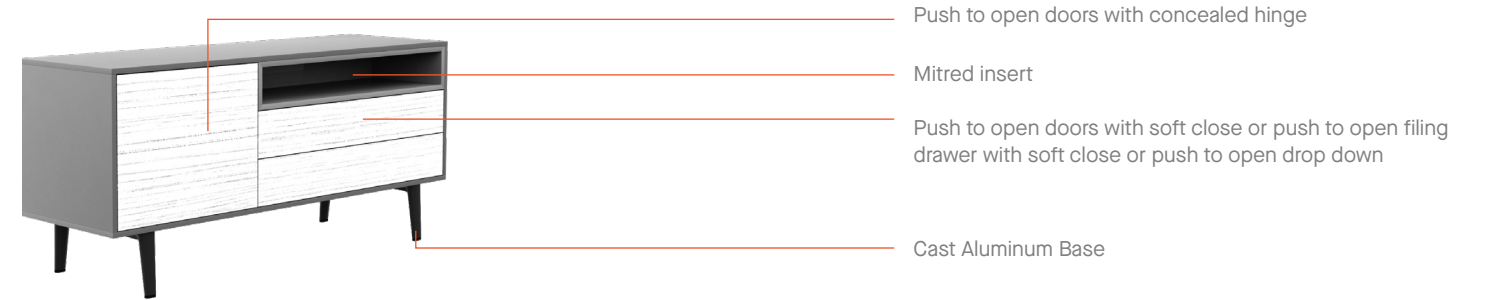

Storage Combinations – mitred insert as standard
 40" combination options
 2 x single drawer
 1 x filing drawer
 1 x drop down
 63" combination options
 2 x single drawer, 1 x door
 1 x filing drawer, 1 x door
 1 x drop down, 1 x door
 87" combination options
 2 x single drawer, 2 x door
 1 x filing drawer, 2 x door
 1 x drop down, 2 x door

Grain Direction
 Grain direction side to side on all panels.

DIMENSIONS

20" Deep

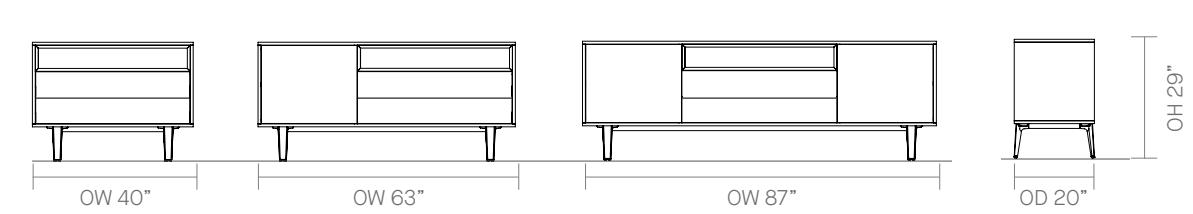

Optional cable management

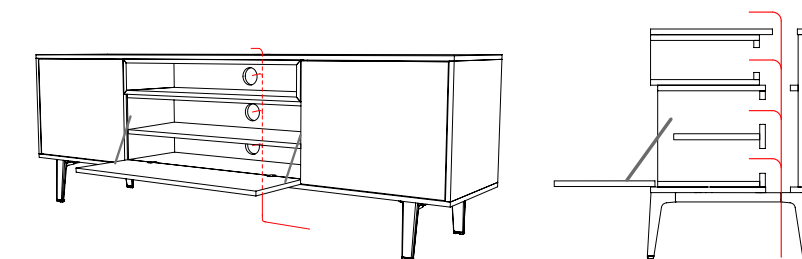

STORAGE: MOTE

MOTE STORAGE HIGH BOARD

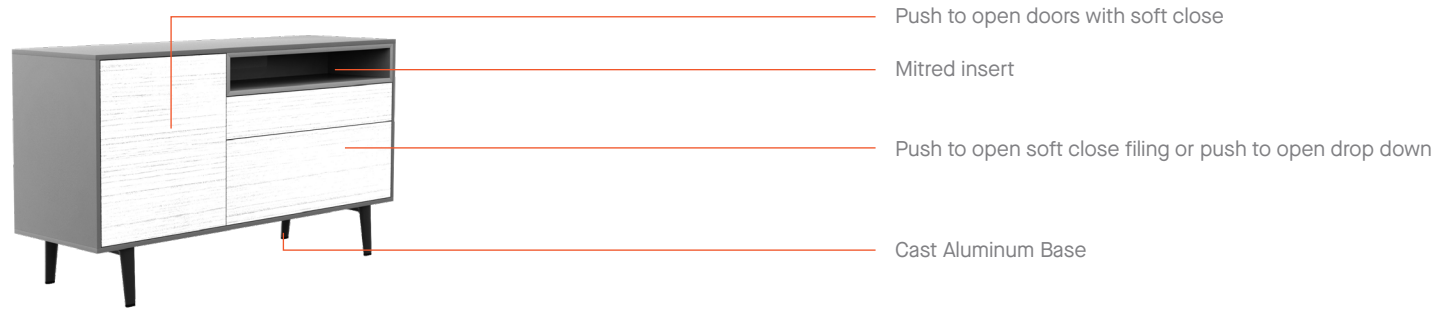

Storage Combinations – mitred insert as standard
 40" combination options
 3 x single drawer
 1 x single, 1 x filing drawer
 63" combination options
 3 x single drawer, 1 door
 1 x single, 1 x filing drawer, 1 x door
 1 x single, 1 x drop down, 1 x door
 87" combination options
 3 x single drawer, 1 x door with fridge/wine rack
 1 x single, 1 x drop down, 1 x door with fridge/wine rack

Grain Direction
 Grain direction side to side on all panels.

STORAGE: MOTE LOW BOARD

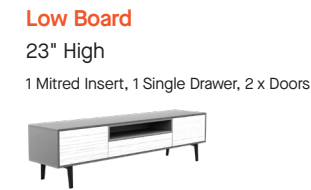
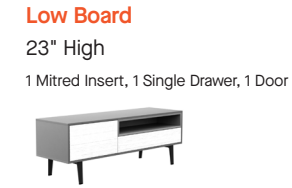

Width (inch)			Code
40" W	63" W	87" W	
-	MSL63DRDWC 3,671	-	TFL
-	-	MSL872DRDWC 4,378	TFL

All prices listed in USD \$
 Ships KD = Knock Down (Assembly Required)

DIMENSIONS

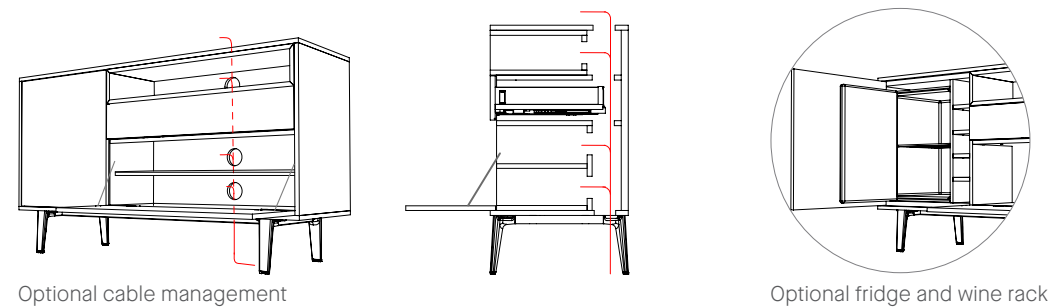
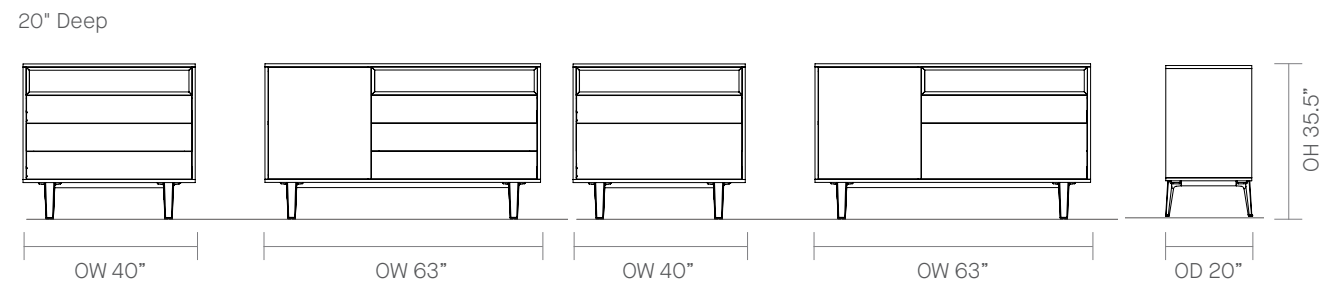

To specify your storage...

1. Select the Codes of the individual items you need to achieve your configuration
2. Choose Finishes where appropriate: 'top' finishes / frame color / fabric color

STORAGE: MOTE SIDE BOARD

		Width (inch)			
		40" W	63" W	87" W	
Mid Board 29" High 1 Mitred Insert, 2 Single Drawers		MSS402DWC 3,968 SEE NOTE 1	-	-	Code TFL
Mid Board 29" High 1 Mitred Insert, 1 Filing Drawer		MSS40DWC 3,591 SEE NOTE 1	-	-	Code TFL
Mid Board 29" High 1 Mitred Insert, 1 Drop Down		MSS40FC 3,423 SEE NOTE 1	-	-	Code TFL
Mid Board 29" High 1 Mitred Insert, 2 Single Drawers, 1 Door		-	MSS63DR2DWC 4,424 SEE NOTE 1	-	Code TFL
Mid Board 29" High 1 Mitred Insert, 1 Filing Drawer, 1 Door		-	MSS63DRDWC 4,095 SEE NOTE 1	-	Code TFL
Mid Board 29" High 1 Mitred Insert, 1 Drop Down, 1 Door		-	MSS63DRFC 3,611 SEE NOTE 1	-	Code TFL
Mid Board 29" High 1 Mitred Insert, 2 Single Drawers, 2 Doors		-	-	MSS872DR2DWC 5,323 SEE NOTE 1	Code TFL
Mid Board 29" High 1 Mitred Insert, 1 Filing Drawer, 2 Doors		-	-	MSS872DRDWC 4,990 SEE NOTE 1	Code TFL
Mid Board 29" High 1 Mitred Insert, 1 Drop Down, 2 Doors		-	-	MSS872DRFC 4,648 SEE NOTE 1	Code TFL

Note 1: For porthole cable management add \$135

All prices listed in USD \$

Ships KD = Knock Down (Assembly Required)

Finishes & Features Available...

TFL	HD Highland Oak UM Urban Maple WH White AT Autumn WK Winter Oak SO Strata Oak CW Carini Walnut DN Denim LG Light Gray
Leg Colors	Black (Textured), Anthracite Gray, Light Gray

STORAGE: MOTE HIGH BOARD

		Width (inch)			
		40" W	63" W	87" W	
Mid Board 35.5" High 1 Mitred Insert, 3 Single Drawers		MSH403DWC 4,616 SEE NOTE 1	-	-	Code TFL
Mid Board 35.5" High 1 Mitred Insert, 1 Filing Drawer, 1 Single Drawer		MSH402DWC 4,321 SEE NOTE 1	-	-	Code TFL
Mid Board 35.5" High 1 Mitred Insert, 1 Drop Down, 1 Single Drawer		MSH40FDWC 3,622 SEE NOTE 1	-	-	Code TFL
Mid Board 35.5" High 1 Mitred Insert, 3 Single Drawers, 1 Door		-	MSH63DR3DWC 5,136 SEE NOTE 1	-	Code TFL
Mid Board 35.5" High 1 Mitred Insert, 1 Filing Drawer, 1 Single Drawer, 1 Door		-	MSH63DR2DWC 4,802 SEE NOTE 1	-	Code TFL
Mid Board 35.5" High 1 Mitred Insert, 1 Drop Down, 1 Single Drawer, 1 Door		-	MSH63DRFDWC 4,600 SEE NOTE 1	-	Code TFL
Mid Board 35.5" High 1 Mitred Insert, 3 Single Drawers, 1 Door with Fridge & Wine Rack		-	MSH63DR3DWCD 7,682 SEE NOTE 1	-	Code TFL
Mid Board 35.5" High 1 Mitred Insert, 1 Single Drawer, 1 Filing Drawer, 1 Door with Fridge & Wine Rack		-	MSH63DR2DWCD 7,337 SEE NOTE 1	-	Code TFL
Mid Board 35.5" High 1 Mitred Insert, 1 Single Drawer, 1 Drop Down, 1 Door with Fridge & Wine Rack		-	MSH63DRFDWCD 7,082 SEE NOTE 1	-	Code TFL

Note 1: For porthole cable management add \$135

All prices listed in USD \$

Ships KD = Knock Down (Assembly Required)

To specify your storage...

1. Select the Codes of the individual items you need to achieve your configuration
2. Choose Finishes where appropriate: 'top' finishes / frame color / fabric color

FINISHES

MOTE STORAGE FINISHES – Standard Top Finishes – TFL (Edge 69)



Carini Walnut



Autumn



Strata Oak



Urban Maple



Highland Oak



Winter Oak

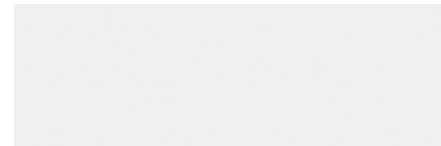

White



Light Gray



Denim

MOTE LEG FINISHES



Black (Textured)

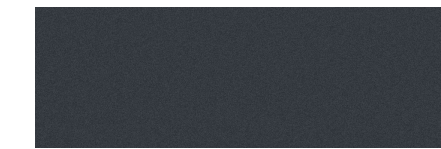

Anthracite Gray

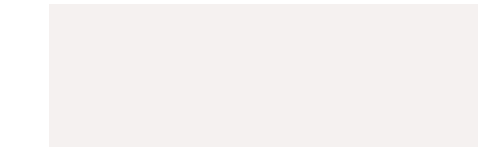

Light Gray

Color images above are for reference only. Please verify with actual color sample.