

**SENATOR**

**PAILO**

# PAILO

With every Senator design comes a great deal of thought. The design process starts way before pencil reaches paper, beginning with looking at you. We look at how you sit, reach, move and work to create a design which not only looks beautiful, but is a pleasure to use too.

Behind every Senator product is a fusion of intelligent thinking and innovative engineering to create products which support people whether they're focusing, collaborating, presenting or organizing.

## PAILO

### STANDARD FEATURES (\*Selected models only)

- Solid Ash sculpted legs
- Tooled Aluminum components
- Hidden frame attachments
- Leveling feet
- Scalloped cable access
- 1" TFL table tops (Edge 69), or 1" Laminate on ply tops (Edge 33)

### SPECIFIABLE FEATURES

- In-line or back to back frames

### COMPLEMENTARY OPTIONS

- Desk gantry for hanging screens
- Adjustable drupe screens
- Hanging screens
- Bench desk cloud screens
- Single desk cloud screens (integrated modesty panel)
- Suspended lighting
- In-desk power modules for project tables
- Cable trays in accent colors
- Wire under-desk storage caddy

### ACCESSORIES

- Monitor arms
- Electrical accessories

### PERFORMANCE STANDARDS

Designed to conform to and where applicable is tested to the following standards:

- BIFMA X5.5 x2014

## DIMENSIONS

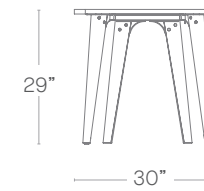

Single desk

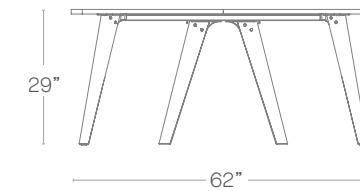

Back to back bench

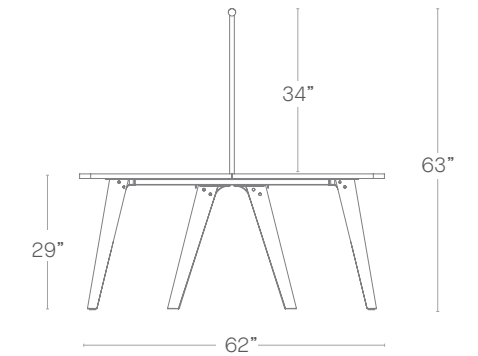

Back to back bench with gantry



Single executive desk  
Widths. 48" - 78"  
Depth. 30"



Stand alone desk  
Widths. 48" - 78"  
Depth. 30"



2 Person in-line desk

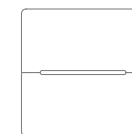

2 Person cluster  
Widths. 48" - 78"  
Depth. 62"

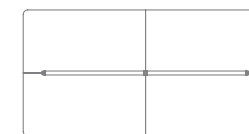

4 Person cluster



Project table  
Widths. 96" - 192"  
Depth. 62"

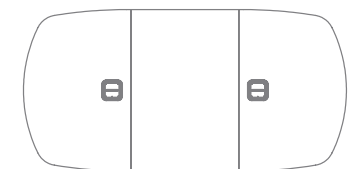

Boat shaped project table  
Widths. 96" - 192"  
Depth. 72"

STATEMENT OF LINE

PAILO SINGLE DESKS

● Available  
□ Not available

Single Desk

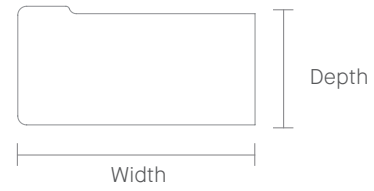

	48" W	54" W	60" W	72" W	78" W
30" D	●	●	●	●	●

Single Stand Alone Desk



	48" W	54" W	60" W	72" W	78" W
30" D	●	●	●	●	●

Executive Single Desk

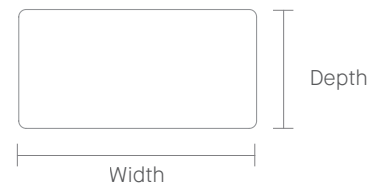

	48" W	54" W	60" W	72" W	78" W
30" D	●	●	●	●	●

Single Desk Screens / Cable Trays

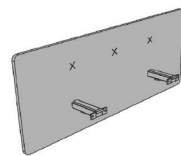
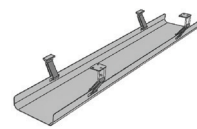

Single tray

Cloud screen with modesty panel

	48" W	54" W	60" W	72" W	78" W
	●	●	●	●	●

STATEMENT OF LINE

PAILO BACK TO BACK DESKS

● Available  
□ Not available

Back to Back Desk

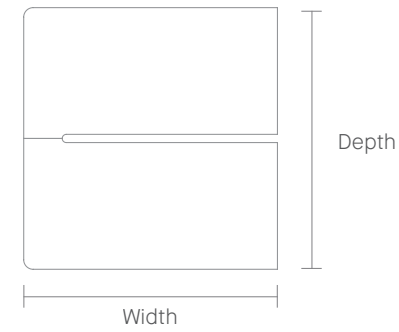

	48" W	54" W	60" W	72" W	78" W
62" D	●	●	●	●	●

Stand Alone Back to Back Desk

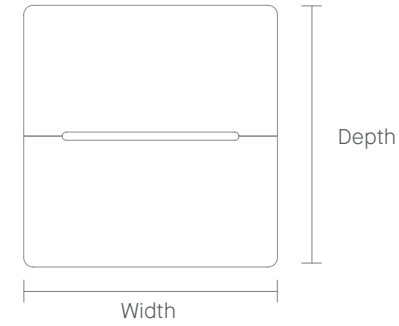

	48" W	54" W	60" W	72" W	78" W
62" D	●	●	●	●	●

Back to Back Desk Screens / Cable Trays

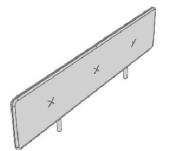
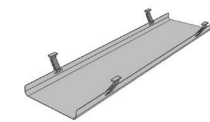

Double cable tray

Cloud screen

	48" W	54" W	60" W	72" W	78" W
	●	●	●	●	●

Wire Management



Vertical cable riser

PAILO SCREENS AND ACCESSORIES

● Available  
□ Not available

Gantry



Stand alone gantry



Starter gantry



Mid and end add on gantry

48" W	54" W	60" W	72" W	78" W
●	●	●	●	●

Screens

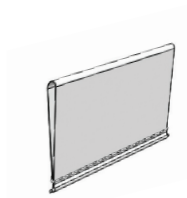

Adjustable drape screen

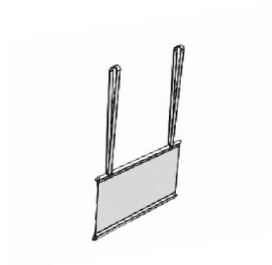

Hanging screen

48" W	54" W	60" W	72" W	78" W
●	●	●	●	●

Accessories

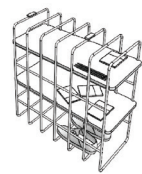

Wire caddy

PAILO PROJECT TABLES

● Available  
□ Not available

Project Table

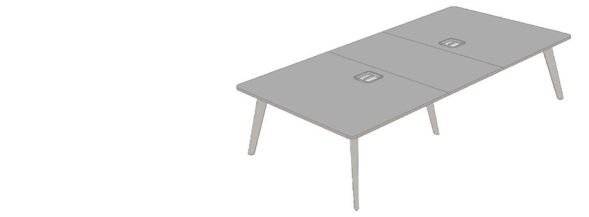
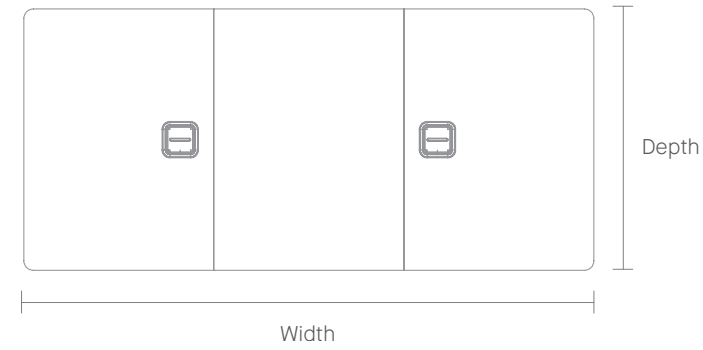

62" D	96" W	144" W	192" W
	●	●	●

Boat Shaped Project Table

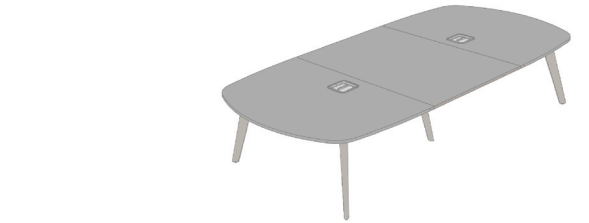
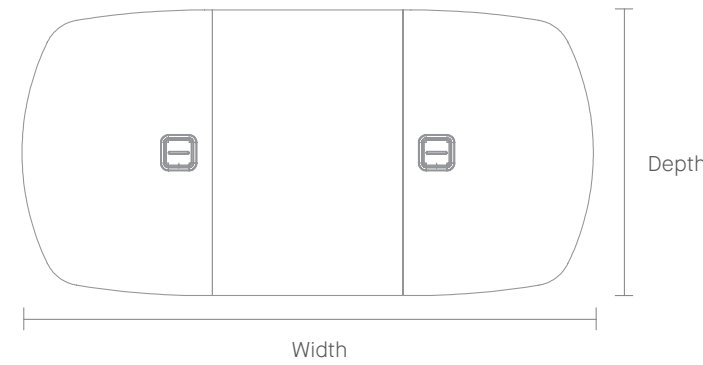

72" D	96" W	144" W	192" W
	●	●	●

PAILO SINGLE DESK

STARTER DESK

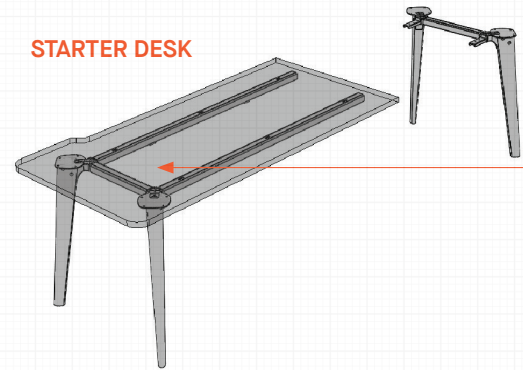

In-line desks are created by connecting an add on desk to a starter desk. You are able to link as many add on desks as necessary to complete your configuration.

**Starter Desk**  
A Starter Desk is comprised of (2) end legs, (2) beams, (1) starter work surface and all corresponding hardware.

MID ADD ON

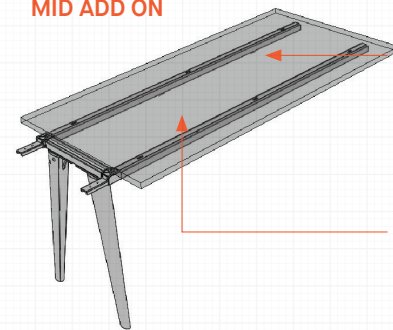

**Beams**  
Beams connect the legs together and support the tops. The beams feature an extruded profile which can be used to attach accessories.

**Mid Add On**  
A Mid Add On desk is comprised of (1) mid leg, (2) beams, (1) mid work surface and all corresponding hardware and components.

END ADD ON

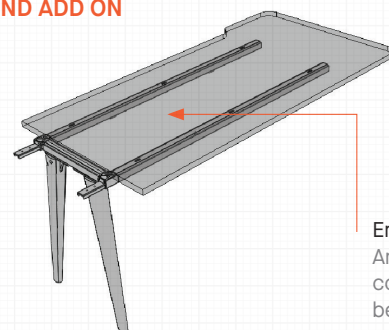

**End Add On**  
An End Add On desk is comprised of (1) mid leg, (2) beams, (1) end work surface and all corresponding hardware and components.

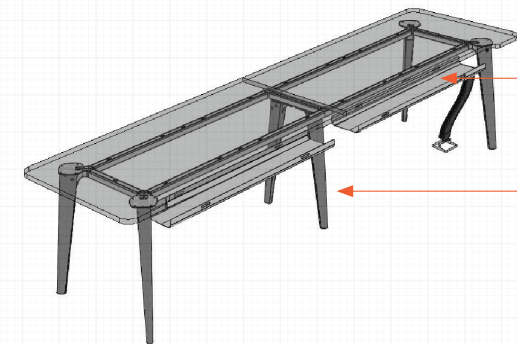

**Cable Tray**  
Cable trays are available to manage power options. (1) Single cable tray is needed per starter desk and every additional add on.

**Vertical Riser**  
The vertical riser is used to transport power cables from the ground to the cable tray. It is attached to the underside of the cable tray and can be positioned along the tray for central desk or end desk fed power.

BENCH WITH SCREENS

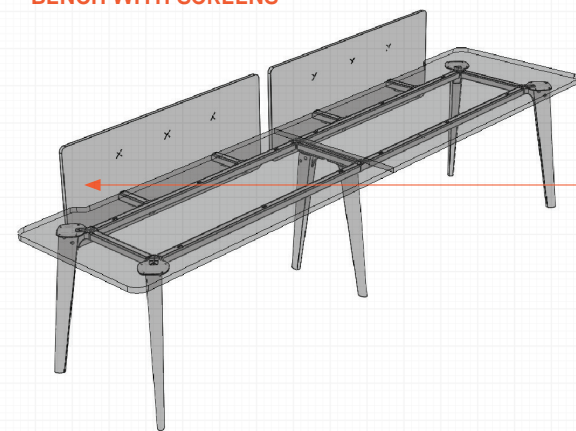

**Screen / Modesty Panel**  
Screens are also available to separate benches to allow for more private working. The screens for single desks extend below the desk surface to act as an integral modesty panel.

WORK SURFACES

On single benches, one top is supplied per starter desk.

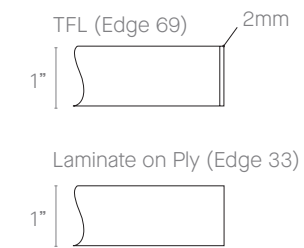
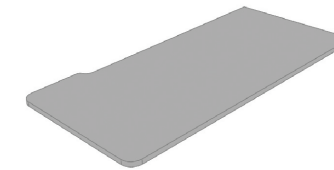

Pailo tops are available in 30" depth and lengths of 48", 54", 60", 72" and 78". Surfaces can be specified in TFL (Edge 69) or Laminate faced plywood.

FRAMEWORK

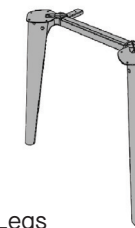

**End Legs**  
Single end legs are for 30" deep tops. Each end leg has spigots protruding from the frame to allow the beam to be attached into place. Adjustable feet are standard.

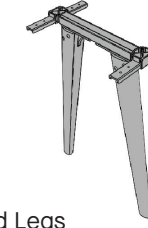

**Mid Legs**  
Mid legs are used to connect starter desks and add-on desks. They have double sided spigots to attach beams to both sides and come with adjustable feet as standard.



**Beams**  
Extruded Aluminum beams are used to connect the legs together. They bolt at each end to the spigots and also through to the top with a channel to hide the attachments. Beams come in widths of 48", 54", 60", 72" and 78".

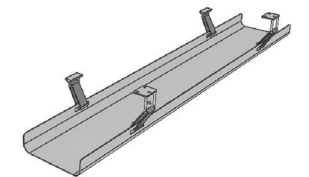

**Cable Trays**  
Cable trays hang from the beams using leather straps. These allow for power blocks to be housed along with any wires or loose cables.

SCREENS AND ACCESSORIES



**Vertical Riser**  
An optional fabric vertical cable riser with zip opening is available to allow power cables to be taken neatly from the floor to the cable tray or directly to the work surface. The riser attaches to the cable tray and has a weighted wire base. Available in black fabric.

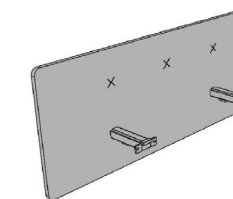

**Cloud Screen with Modesty Panel**  
The cloud screen mounts directly to the desks understructure. The screens for single desks extend below the desk surface to act as an integral modesty panel. Cloud screens measure 40.5" from the floor to the top of the screen.



**Above Desk Power**  
An optional above desk power module can be added for convenient power access. 2 power outlets, and 2 charging USB ports are included. Above desk power is available with a 10 foot 3 prong plug, or 10 foot hardwire infeed.

**PAILO BACK TO BACK BENCH**

**STARTER DESK**

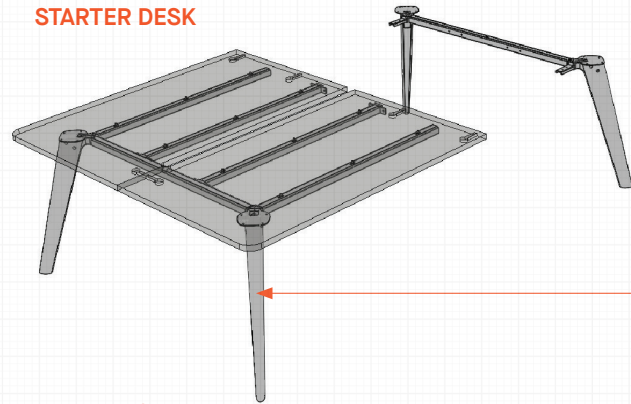

Benches are created by connecting an add on desk to a starter desk. You are able to link as many add on desks as necessary to complete your configuration.

**Starter Bench**

A Starter bench is comprised of (2) end legs, (4) beams, (2) starter work surfaces and all corresponding hardware and plastic components.

**MID ADD ON**

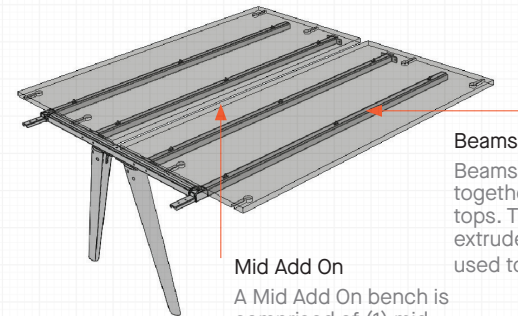

**Mid Add On**

A Mid Add On bench is comprised of (1) mid leg, (4) beams, (2) mid work surfaces and all corresponding hardware and components.

**Beams**

Beams connect the legs together and support the tops. The beams feature an extruded profile which can be used to attach accessories.

**END ADD ON**

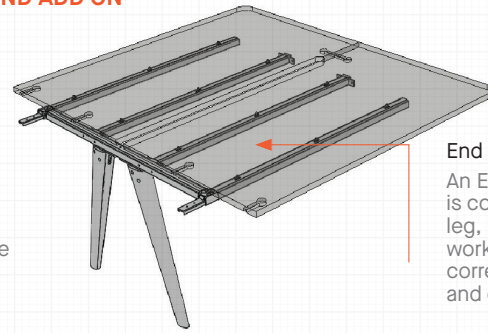

**End Add On**

An End Add On bench is comprised of (1) mid leg, (4) beams, (2) end work surfaces and all corresponding hardware and components.

**BENCH WITH CABLE MANAGEMENT**

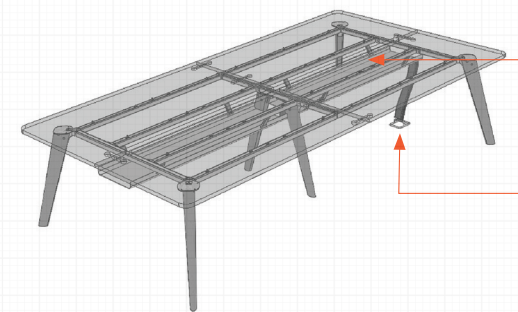

**Cable Tray**

Cable trays are available to manage power options. (1) Single cable tray is needed per starter desk and every additional add on.

**Vertical Riser**

The vertical riser is used to transport power cables from the ground to the double cable tray. It is attached to the underside of the cable tray and can be positioned at either end of the cable tray.

**CLOUD SCREENS**

Screens are also available to separate benches to allow for more private working.

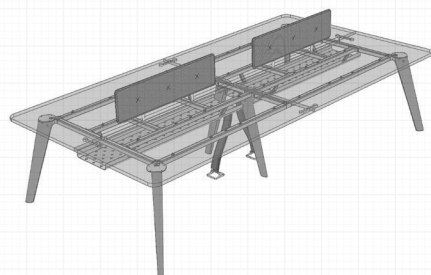

**ADJUSTABLE / HANGING SCREEN**

**Gantry**

The gantry can be used to hang screens, lighting and personal accessories.

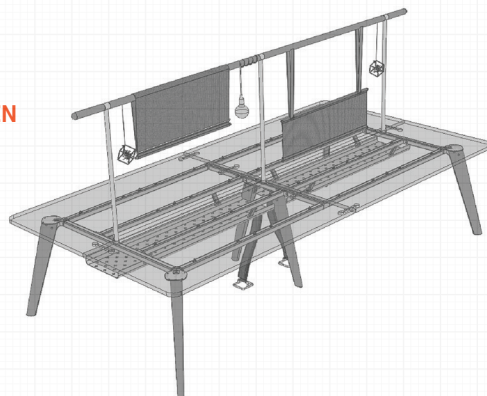

**WORK SURFACES**

On back to back benches two tops are supplied. Back to back configurations will result in 62" overall depths due to central gap for cable access.

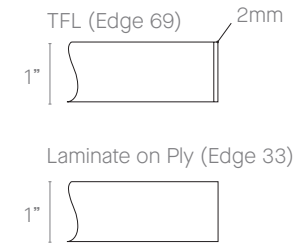
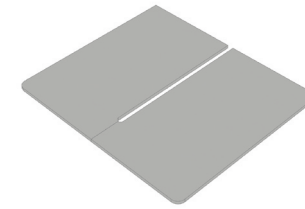

Pailo tops are available in 62" depth and lengths of 48", 54", 60", 72' and 78". Surfaces can be specified in TFL (Edge 69) or Laminate faced plywood.

**FRAMEWORK**



**End Legs**

Bench end legs are 62" wide. Each end leg has spigots protruding from the frame to allow the beam to be attached into place. Adjustable feet are fitted as standard.

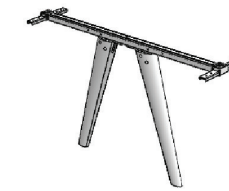

**Mid Legs**

Mid legs are used to connect starter desks and add-on desks. They have double sided spigots to attach beams to both sides and come with adjustable feet as standard.



**Beams**

Extruded aluminum beams are used to connect the legs together. They bolt at each end of the spigots and also through the top with a channel to hide the fixings. Beams are available to suit the table widths of 48", 54", 60", 72" and 78".

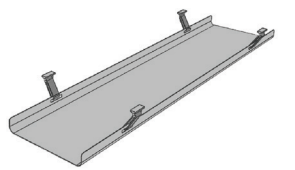

**Cable Trays**

Cable trays hang from the beams from leather straps. These allow for power blocks to be housed along with any wires or loose cables.

**SCREENS AND ACCESSORIES**

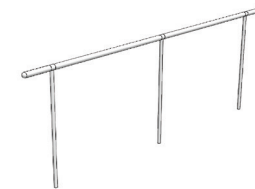

**Gantry**

The gantry mounts directly to the desks understructure and can be used to hang accessories such as screens and lighting. Constructed of metal uprights and a wooden top rail.

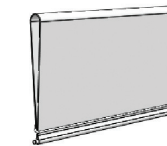

**Adjustable drape screen**

The adjustable drape screen is for use with the gantry. The fabric screen is suspended and can be raised or lowered by the user depending on the amount of privacy desired.



**Hanging screen**

The hanging screen is for use with the gantry. The fabric screen is suspended via 2 bridle leather straps.

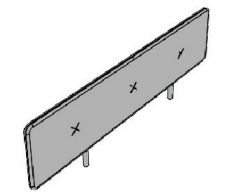

**Cloud screen**

The cloud screen mounts directly to the desk frame. Screens feature an 'X' detail in the screen upholstery. Cloud screens measure 41" from the floor to the top of the screen.

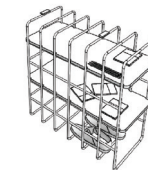

**Wire caddy**

The wire caddy is suspended from the desk beams and includes 2 adjustable shelves to allow personal belongings to be kept off the floor and close to hand. When the shelves are removed, the Wire Caddy can be used as a CPU holder. Available in 6 accessory colors.



**Vertical Riser**

An optional fabric vertical cable riser with zip opening is available to allow power cables to be taken neatly from the floor to the cable tray or directly to the work surface. The riser attaches to the cable tray and has a weighted wire base. Available in black fabric.



**Above Desk Power**

An optional above desk power module can be added for convenient power access. 2 power outlets, and 2 charging USB ports are included. Above desk power is available with a 10 foot 3 prong plug, or 10 foot hardwire infeed.

PAILO PROJECT TABLES



**Project Tops**  
Project table tops are made with uniformly sized top panels so there is no central joint between the tops.

**Power Option**  
Simple power access via drop in cover.

**Power Option**  
Choice of 2 pre-configured power options.

**Wire Management**  
Vertical cable manager takes power neatly up to the desk.

WORK SURFACES

Project table tops are made with uniformly sized top panels so there is no central joint between the tops.  
The grain direction runs with the depth of the surface.

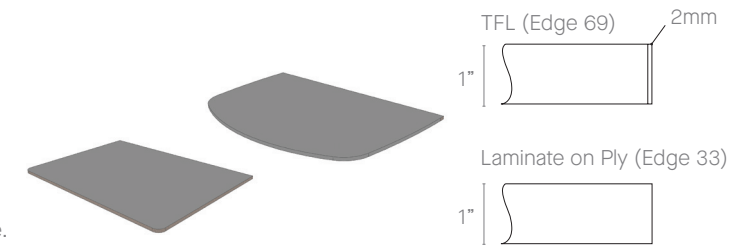

Project tables are available in 62" or 72" depth and lengths of 96", 144", and 192". Surfaces can be specified in TFL (Edge 69) or Laminate faced plywood.

FRAMEWORK



**End Legs**  
Project table end legs are 62" wide. Each end leg has spigots protruding from the frame to allow the beam to be attached into place. Adjustable feet are fitted as standard.



**Mid Legs**  
Mid legs are used to connect starter desks and add-on desks. They have double sided spigots to attach beams to both sides and come with adjustable feet as standard.



**Beams**  
Extruded Aluminum beams are used to connect the legs together. They bolt at each end to the spigots and also through to the top with a channel to hide the attachments. Beams are available to suit the table widths of 96", 144" and 192".

POWER AND ACCESSORIES

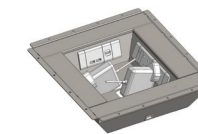

**Code A & B**  
In table power options are available on Pailo project tables. Power option A (4 Power, 4 USB charging) and Power option B (4 Power, 4 USB Charging, and HDMI) are available.



In conjunction with the power units a range of accessories are available. The tray is included with each power unit option, a pen pot and an accessory box can be added if required.

WIRING DIAGRAM

PALLO SINGLE DESK  
TYPICAL WIRING LAYOUT

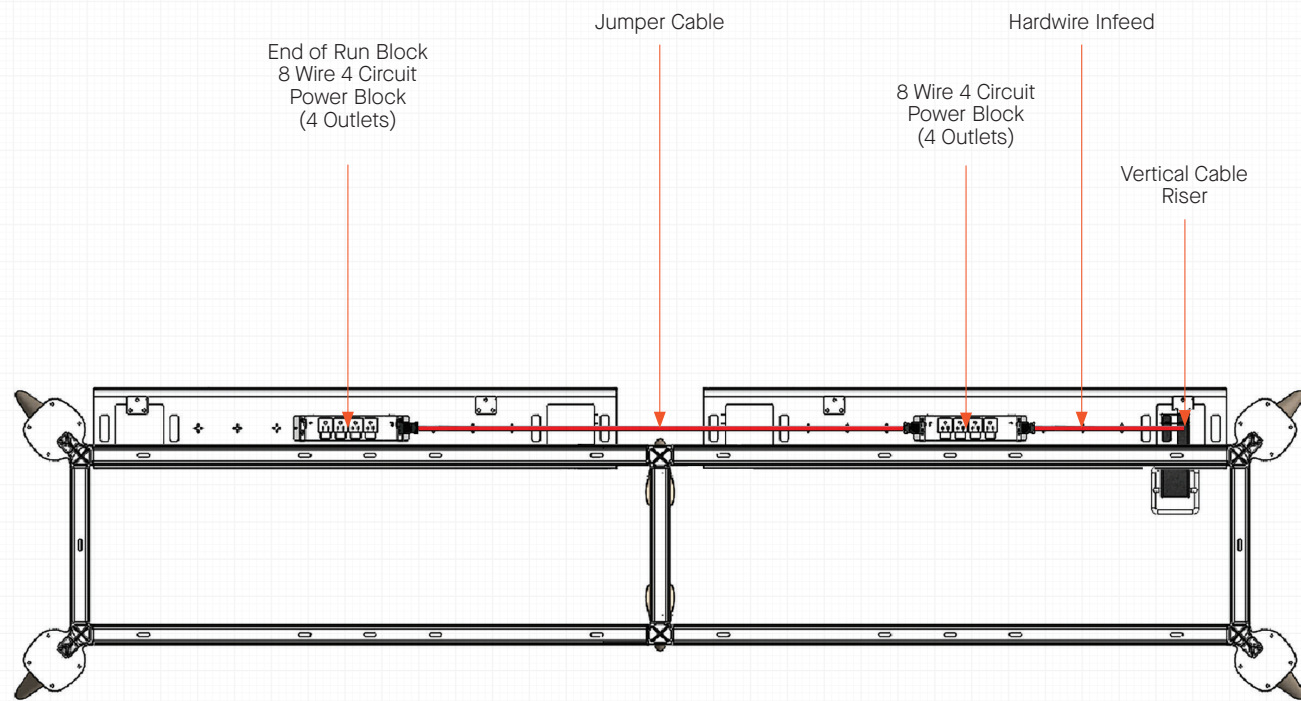
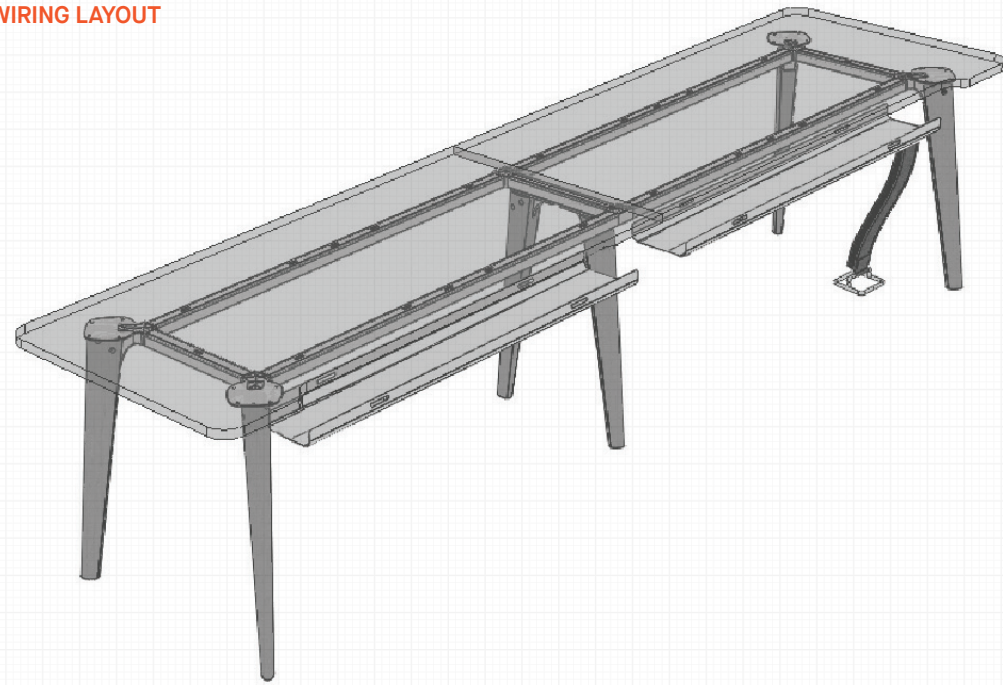

WIRING DIAGRAM



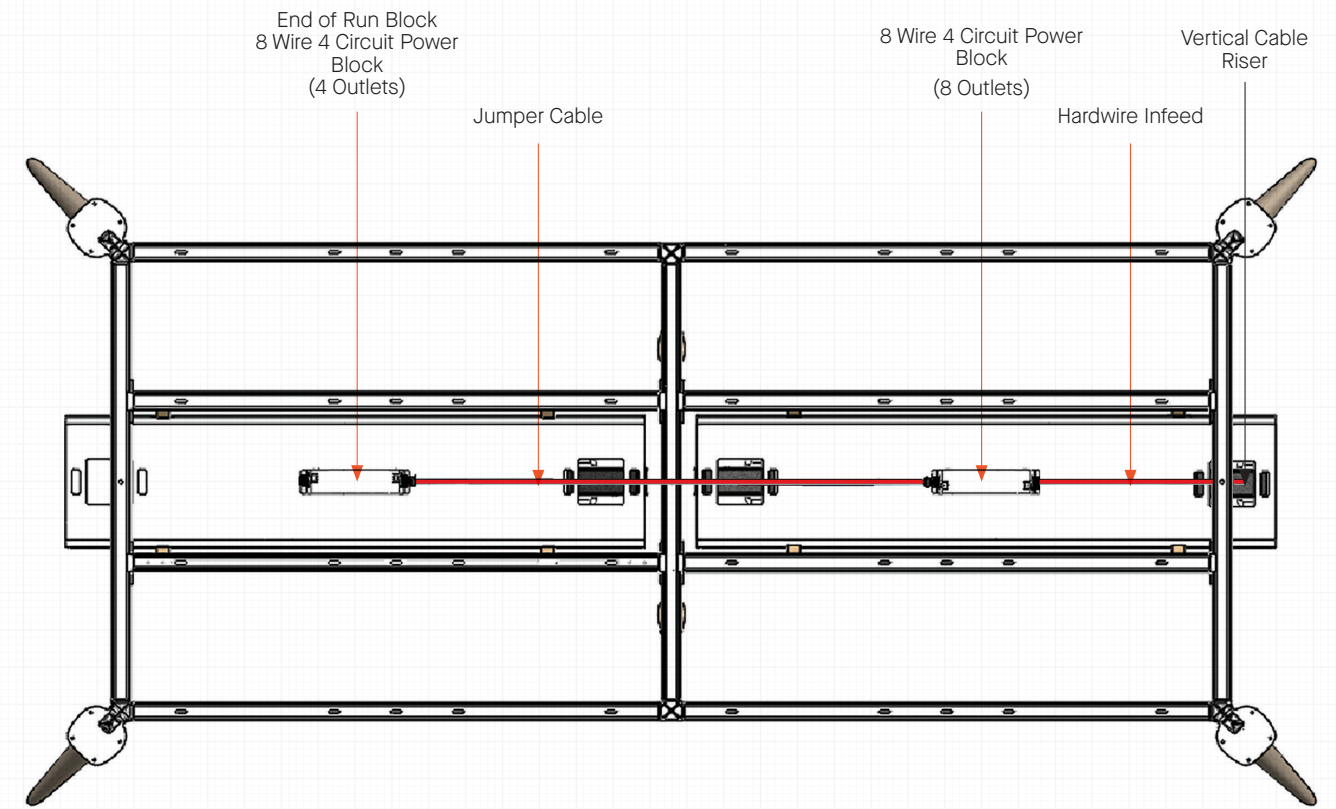
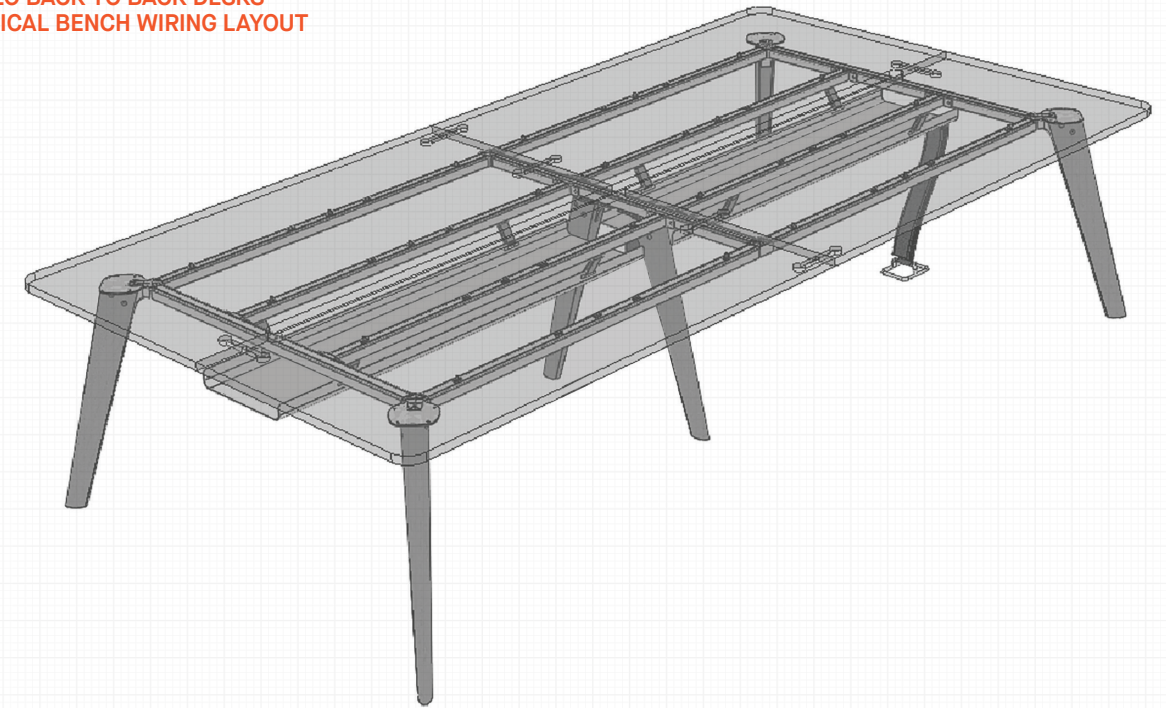

PALLO BACK TO BACK DESKS  
TYPICAL BENCH WIRING LAYOUT





PRODUCT PRICING

PAILO SINGLE DESK

	Width (inch)					Code TFL (Edge 69) Laminate/Ply (Edge 33)
	48" W	54" W	60" W	72" W	78" W	
<b>Executive Single</b> 30" Depth 	<b>PLE4830</b> 3,327 3,932	<b>PLE5430</b> 3,391 4,082	<b>PLE6030</b> 3,447 4,277	<b>PLE7230</b> 3,508 4,461	<b>PLE7830</b> 3,816 4,565	
<b>Single Stand Alone</b> 30" Depth 	<b>PL4830S</b> 3,327 3,932	<b>PL5430S</b> 3,391 4,082	<b>PL6030S</b> 3,447 4,277	<b>PL7230S</b> 3,508 4,461	<b>PL7830S</b> 3,816 4,565	Code TFL (Edge 69) Laminate/Ply (Edge 33)
<b>Single Starter</b> 30" Depth 	<b>PL4830</b> 3,327 3,932	<b>PL5430</b> 3,391 4,082	<b>PL6030</b> 3,447 4,277	<b>PL7230</b> 3,508 4,461	<b>PL7830</b> 3,815 4,565	Code TFL (Edge 69) Laminate/Ply (Edge 33)
<b>Single Add On Mid</b> 30" Depth 	<b>PL4830MA</b> 1,978 2,583	<b>PL5430MA</b> 2,024 2,712	<b>PL6030MA</b> 2,059 2,880	<b>PL7230MA</b> 2,102 3,055	<b>PL7830MA</b> 2,143 3,142	Code TFL (Edge 69) Laminate/Ply (Edge 33)
<b>Single Add On End</b> 30" Depth 	<b>PL4830EA</b> 1,978 2,583	<b>PL5430EA</b> 2,024 2,712	<b>PL6030EA</b> 2,059 2,880	<b>PL7230EA</b> 2,102 3,055	<b>PL7830EA</b> 2,143 3,142	Code TFL (Edge 69) Laminate/Ply (Edge 33)

All prices listed in USD \$

Ships Semi-KD = Knock Down (Needs some assembly)

PRODUCT PRICING

PAILO SINGLE DESK – Cable Management

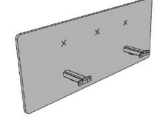
	Width (inch)					Code Price
	48" W	54" W	60" W	72" W	78" W	
<b>Horizontal Cable Tray</b> Single cable tray 	<b>PLCT48</b> 360	<b>PLCT54</b> 380	<b>PLCT60</b> 401	<b>PLCT72</b> 421	<b>PLCT78</b> 442	
<b>Vertical Cable Riser</b> 	<b>PLVCM</b> 262 SEE NOTE 1					Code Price
<b>Cloud Screen with Modesty Panel</b> 	<b>PLMS48</b> 879 SEE NOTE 2	<b>PLMS54</b> 907 SEE NOTE 2	<b>PLMS60</b> 922 SEE NOTE 2	<b>PLMS72</b> 942 SEE NOTE 2	<b>PLMS78</b> 962 SEE NOTE 2	Code Price

Note 1: Only for use with cable trays. Available in Black fabric.  
Note 2: Upholstered in Camira Blazer or Camira Synergy.

All prices listed in USD \$  
Ships Semi-KD = Knock Down (Needs some assembly)

Finishes & Features Available...

TFL (Edge 69)	HD Highland Oak   UM Urban Maple   WH White   AT Autumn   WK Winter Oak   SO Strata Oak   CW Carini Walnut   DN Denim   LG Light Grey
Laminates	Global Laminates
Frame Colors	Black   White   Pistachio   Totally Orange   Peacock Blue
Leg Colors	Matte Clear Finish   Black Stain
Accessory Colors	Black   White   Pistachio   Totally Orange   Peacock Blue
Screen Fabrics	Camira Blazer   Camira Synergy

To specify your desk...

1. Think through the configuration of Desk you require
2. Select the Codes of the individual items you need to achieve your configuration
3. Choose Finishes where appropriate: 'top' finishes / frame color / fabric color / acrylic color
4. Consider supporting product, screens, cable management and accessories

PRODUCT PRICING



PAILO BACK TO BACK BENCH

		Width (inch)					
		48" W	54" W	60" W	72" W	78" W	
<b>Back to Back Stand Alone</b> 62" Depth 	<b>PLB4862</b>	<b>4,220</b>	<b>4,405</b>	<b>4,427</b>	<b>4,571</b>	<b>4,719</b>	Code TFL (Edge 69) Laminate/Ply (Edge 33)
	<b>5,465</b>	<b>5,836</b>	<b>6,112</b>	<b>6,438</b>	<b>6,756</b>		
<b>Back to Back Starter</b> 62" Depth 	<b>PLB4862S</b>	<b>4,220</b>	<b>4,405</b>	<b>4,427</b>	<b>4,571</b>	<b>4,719</b>	Code TFL (Edge 69) Laminate/Ply (Edge 33)
	<b>5,465</b>	<b>5,836</b>	<b>6,112</b>	<b>6,438</b>	<b>6,756</b>		
<b>Back to Back Add On Mid</b> 62" Depth 	<b>PLB4862MA</b>	<b>2,958</b>	<b>3,042</b>	<b>3,125</b>	<b>3,211</b>	<b>3,293</b>	Code TFL (Edge 69) Laminate/Ply (Edge 33)
	<b>4,203</b>	<b>4,473</b>	<b>4,810</b>	<b>5,034</b>	<b>5,845</b>		
<b>Back to Back Add On End</b> 62" Depth 	<b>PLB4862EA</b>	<b>2,958</b>	<b>3,042</b>	<b>3,125</b>	<b>3,211</b>	<b>3,293</b>	Code TFL (Edge 69) Laminate/Ply (Edge 33)
	<b>4,203</b>	<b>4,473</b>	<b>4,810</b>	<b>5,034</b>	<b>5,845</b>		

All prices listed in USD \$  
 Ships Semi-KD = Knock Down (Needs some assembly)

PRODUCT PRICING

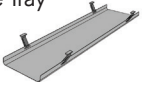
PAILO BACK TO BACK BENCH – Cable Management

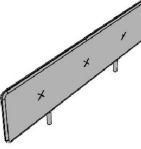
		Width (inch)					
		48" W	54" W	60" W	72" W	78" W	
<b>Horizontal Cable Tray</b> Double Cable Tray 	<b>PLDCT48</b>	<b>433</b>	<b>460</b>	<b>497</b>	<b>527</b>	<b>544</b>	Code Price
	SEE NOTE 1	SEE NOTE 1	SEE NOTE 1	SEE NOTE 1	SEE NOTE 1	SEE NOTE 1	
<b>Vertical Cable Riser</b> 	<b>PLVCM</b>						Code Price
	<b>262</b>					SEE NOTE 2	
<b>Wire Caddy</b> Includes 2 shelves 10" W x 22" H x 22" D 	<b>PLWC</b>						Code Price
	<b>442</b>					SEE NOTE 1	
<b>Cloud Screen</b> 	<b>PLCS48</b>	<b>769</b>	<b>803</b>	<b>840</b>	<b>876</b>	<b>917</b>	Code Price
	SEE NOTES 1 & 3	SEE NOTES 1 & 3	SEE NOTES 1 & 3	SEE NOTES 1 & 3	SEE NOTES 1 & 3	SEE NOTES 1 & 3	

Note 1: Metal may be finished in Black, White, Pistachio, Totally Orange, Peacock Blue. All prices listed in USD \$  
 Note 2: Only for use with cable trays. Ships Semi-KD = Knock Down (Needs some assembly)  
 Note 3: Upholstered in Camira Blazer or Camira Synergy.

Finishes & Features Available...



TFL (Edge 69)	HD Highland Oak   UM Urban Maple   WH White   AT Autumn   WK Winter Oak   SO Strata Oak   CW Carini Walnut   DN Denim   LG Light Grey
Laminates	Global Laminates
Frame Colors	Black   White   Pistachio   Totally Orange   Peacock Blue
Leg Colors	Matte Clear Finish   Black Stain
Accessory Colors	Black   White   Pistachio   Totally Orange   Peacock Blue
Screen Fabrics	Camira Blazer   Camira Synergy

To specify your desk...

1. Think through the configuration of Desk you require
2. Select the Codes of the individual items you need to achieve your configuration
3. Choose Finishes where appropriate: 'top' finishes / frame color / fabric color / acrylic color
4. Consider supporting product, screens, cable management and accessories

PRODUCT PRICING

PAILO SCREENS AND LIGHTING

	Width (inch)					Code	Price
	48" W	54" W	60" W	72" W	78" W		
<b>Stand Alone Gantry</b> 	<b>PLG48</b> <b>496</b> SEE NOTE 1	<b>PLG54</b> <b>524</b> SEE NOTE 1	<b>PLG60</b> <b>541</b> SEE NOTE 1	<b>PLG72</b> <b>564</b> SEE NOTE 1	<b>PLG78</b> <b>626</b> SEE NOTE 1		
<b>Starter Gantry</b> 	<b>PLG48S</b> <b>496</b> SEE NOTE 1	<b>PLG54S</b> <b>524</b> SEE NOTE 1	<b>PLG60S</b> <b>541</b> SEE NOTE 1	<b>PLG72S</b> <b>564</b> SEE NOTE 1	<b>PLG78S</b> <b>626</b> SEE NOTE 1		
<b>Add On Gantry Mid</b> 	<b>PLG48MA</b> <b>312</b> SEE NOTE 1	<b>PLG54MA</b> <b>346</b> SEE NOTE 1	<b>PLG60MA</b> <b>393</b> SEE NOTE 1	<b>PLG72MA</b> <b>408</b> SEE NOTE 1	<b>PLG78MA</b> <b>426</b> SEE NOTE 1		
<b>Add On Gantry End</b> 	<b>PLG48EA</b> <b>281</b> SEE NOTE 1	<b>PLG54EA</b> <b>407</b> SEE NOTE 1	<b>PLG60EA</b> <b>393</b> SEE NOTE 1	<b>PLG72EA</b> <b>408</b> SEE NOTE 1	<b>PLG72EA</b> <b>410</b> SEE NOTE 1		

Note 1: Metal may be finished in Black, White, Pistachio, Totally Orange, Peacock Blue. Wood may be finished in Matte Clear or Black Stain. Finishes must be specified when ordering.

All prices listed in USD \$



Ships Semi-KD = Knock Down (Needs some assembly)

Finishes & Features Available...

TFL (Edge 69)	HD Highland Oak   UM Urban Maple   WH White   AT Autumn   WK Winter Oak   SO Strata Oak   CW Carini Walnut   DN Denim   LG Light Grey
Laminates	Global Laminates
Frame Colors	Black   White   Pistachio   Totally Orange   Peacock Blue
Leg Colors	Matte Clear Finish   Black Stain
Accessory Colors	Black   White   Pistachio   Totally Orange   Peacock Blue
Screen Fabrics	Camira Blazer   Camira Synergy

PRODUCT PRICING

PAILO SCREENS AND LIGHTING

	Width (inch)					Code	Price
	48" W	54" W	60" W	72" W	78" W		
<b>Adjustable Drape Screen</b> 	<b>PLAS48</b> <b>529</b> SEE NOTES 1 & 2	<b>PLAS54</b> <b>549</b> SEE NOTES 1 & 2	<b>PLAS60</b> <b>570</b> SEE NOTES 1 & 2	<b>PLAS72</b> <b>592</b> SEE NOTES 1 & 2	<b>PLAS78</b> <b>606</b> SEE NOTES 1 & 2		
<b>Hanging Screen</b> 	<b>PLHS48</b> <b>550</b> SEE NOTE 1	<b>PLHS54</b> <b>569</b> SEE NOTE 1	<b>PLHS60</b> <b>596</b> SEE NOTE 1	<b>PLHS72</b> <b>613</b> SEE NOTE 1	<b>PLHS78</b> <b>630</b> SEE NOTE 1		

Note 1: Upholstered in Camira Blazer or Camira Synergy.

Note 2: Metal may be finished in Black, White, Pistachio, Totally Orange, Peacock Blue





All prices listed in USD \$

Ships Semi-KD = Knock Down (Needs some assembly)

To specify your desk...

1. Think through the configuration of Desk you require
2. Select the Codes of the individual items you need to achieve your configuration
3. Choose Finishes where appropriate: 'top' finishes / frame color / fabric color / acrylic color
4. Consider supporting product, screens, cable management and accessories

PAILO PROJECT TABLES

	Width (inch)			Code TFL (Edge 69) Laminate/Ply (Edge 33)
	96" W	144" W	192" W	
<b>Project Table No Cut Out</b> 62" Depth 	<b>PLMT9662</b> 6,583 9,146	<b>PLMT14462</b> 7,504 11,375	<b>PLMT19262</b> 10,238 15,364	
<b>Boat Shaped Project Table No Cut Out</b> 72" Depth 	<b>PLBMT9672</b> 6,614 9,376	<b>PLBMT14472</b> 7,555 11,699	<b>PLBMT19272</b> 10,305 15,830	
<b>Project Table with cut out for Power Option A or B</b> 62" Depth 	<b>PLMT9662-AB</b> 6,583 9,146 SEE NOTE 1	<b>PLMT14462-AB</b> 7,504 11,375 SEE NOTE 1	<b>PLMT19262-AB</b> 10,238 15,364 SEE NOTE 2	
<b>Boat Shaped Project Table with cut out for Power Option A or B</b> 72" Depth 	<b>PLBMT9672-AB</b> 6,614 9,376 SEE NOTE 1	<b>PLBMT14472-AB</b> 7,555 11,699 SEE NOTE 1	<b>PLBMT19272-AB</b> 10,305 15,830 SEE NOTE 2	

Note 1: If electrical options are specified for these tops, 2 power units are required. Power modules to be ordered separately. Click to see details

Note 2: If electrical options are specified for these tops, 4 power units are required. Power modules to be ordered separately. Click to see details

All prices listed in USD \$  
Ships Semi-KD = Knock Down (Needs some assembly)

Finishes & Features Available...

TFL (Edge 69)	HD Highland Oak   UM Urban Maple   WH White   AT Autumn   WK Winter Oak   SO Strata Oak   CW Carini Walnut   DN Denim   LG Light Grey
Laminates	Global Laminates
Frame Colors	Black   White   Pistachio   Totally Orange   Peacock Blue
Leg Colors	Matte Clear Finish   Black Stain
Accessory Colors	Black   White   Pistachio   Totally Orange   Peacock Blue
Screen Fabrics	Camira Blazer   Camira Synergy

PAILO PROJECT TABLE POWER OPTIONS

	Electrical Option		Code Price
	A	B	
<b>Power Module in Black</b> • In table • Four power outlets • 10 ft power cord with 3-prong plug 		<b>ALPUSMDP4P</b> 1,091	
<b>Power Module in Black</b> • In table • Four power outlets • 1 HDMI • Four powered USB • 10 ft power cord with 3-prong plug 		<b>ALPUSMDP4PAV</b> 1,739	
<b>Pen Pot</b> Only available in White 	<b>DATPP</b> 147		
<b>Pen Box with Lid Accessory</b> Only available in White 	<b>DATPBL</b> 160		

All prices listed in USD \$  
Ships Semi-KD = Knock Down (Needs some assembly)

To specify your desk...

1. Think through the configuration of Desk you require
2. Select the Codes of the individual items you need to achieve your configuration
3. Choose Finishes where appropriate: 'top' finishes / frame color / fabric color / acrylic color
4. Consider supporting product, screens, cable management and accessories

PAILO ACCESSORIES

**M2 Desk Mounted Adjustable Monitor Arm**

Please specify DC if desk clamped or CP for cable port fixed.



<b>M2CLF17DC</b> <b>638</b> SEE NOTE 1	<b>M2CLF17CP</b> <b>638</b> SEE NOTE 1	Code
		Price
<b>ADPSC</b> <b>423</b> SEE NOTE 2		Code
		Price
<b>ADPSS</b> <b>484</b>		Code
		Price

**Above Desk Power (3-Prong Plug)**

- Above table
- White or Black
- Two power outlets
- 1 powered USB-A
- 1 powered USB-C
- 10 ft power cord with 3-prong plug



**Above Desk Power (Hardwire)**

- Above table
- White or Black
- Two power outlets
- 1 powered USB-A
- 1 powered USB-C
- 10 ft hardwire infeed



Note 1: All monitor arms are compatible with most flat screen monitors. Please ensure monitors have VESA mounting. Consult with the Sales Office for more details.

Note 2: Available in White or Black. Please specify when ordering.

All prices listed in USD \$

*Ships Semi-KD = Knock Down (Needs some assembly)*

PAILO POWER

**84 System Hardwire Infeeds. 8 wire 4 Circuit**

For Single, Inline, and Bench desk power block options



**Single Desk Electrical Kit**

- 1 x power block
- 4 x receptacles
- 1 x jumper cable

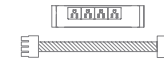

**Single Desk End of Run Block**

- 1 x power block
- 4 x receptacles



**Bench Desk Electrical Kit**

- 1 x power block
- 8 x receptacles
- 1 x jumper cable

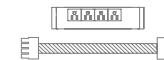

**Bench Desk End of Run Block**

- 1 x power block
- 8 x receptacles



Length (inches)			Code
72"	108"	144"	Price
<b>72HWINF84</b> <b>231</b>	<b>108HWINF84</b> <b>296</b>	<b>144HWINF84</b> <b>363</b>	

Single/Inline Desk Power Blocks					Code
Length (inches)					Price
48"	54"	60"	72"	78"	
<b>EK48SB</b> <b>8W4C</b> <b>372</b>	<b>EK54SB</b> <b>8W4C</b> <b>382</b>	<b>EK60SB</b> <b>8W4C</b> <b>393</b>	<b>EK72SB</b> <b>8W4C</b> <b>416</b>	<b>EK78SB</b> <b>8W4C</b> <b>426</b>	

<b>EKEORSSB</b> <b>197</b>					Code
					Price

Bench Desk Power Blocks					Code
Length (inches)					Price
48"	54"	60"	72"	78"	
<b>EK48DSB</b> <b>8W4C</b> <b>467</b>	<b>EK54DSB</b> <b>8W4C</b> <b>479</b>	<b>EK60DSB</b> <b>8W4C</b> <b>490</b>	<b>EK72DSB</b> <b>8W4C</b> <b>512</b>	<b>EK78DSB</b> <b>8W4C</b> <b>522</b>	

<b>EKEORDSB</b> <b>279</b>					Code
					Price

All prices listed in USD \$

*Ships Semi-KD = Knock Down (Needs some assembly)*

To specify your desk...

1. Think through the configuration of Desk you require
2. Select the Codes of the individual items you need to achieve your configuration
3. Choose Finishes where appropriate: 'top' finishes / frame color / fabric color / acrylic color
4. Consider supporting product, screens, cable management and accessories

# FINISHES

## PAILO FINISHES – Standard Top Finishes – TFL (Edge 69)



Carini Walnut



Autumn



Strata Oak

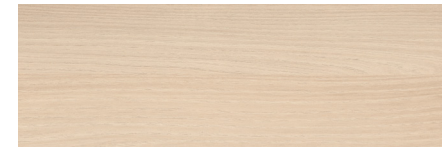

Urban Maple



Highland Oak



Winter Oak

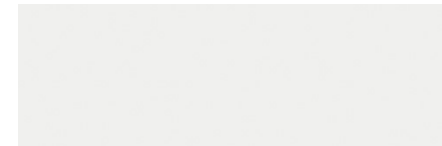

White



Light Gray



Denim

## CONTRASTING EDGE BANDS – For use on TFL (Edge 69) tops only



Ply Effect Edging

### CONTRASTING EDGE BAND

All TFL (Edge 69) tops come with a matching edge band as standard. Contrasting edge band can be specified.

Please contact customer service if you require a contrasting edge band.

**FINISHES**

**PAILO FINISHES**

**GLOBAL LAMINATES**



Fog



Dark Chocolate



Fossil

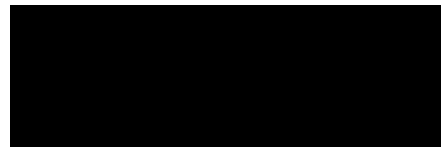

Diamond Black



Mouse

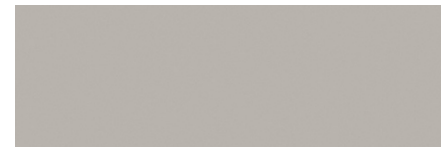

Sarum Gray



Storm



Brite White



Chestnut Woodline



Oiled Walnut



White Ash



Smoky Brown Pear

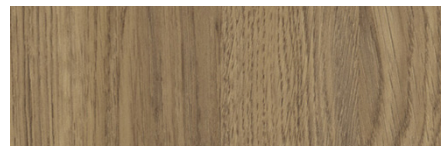

Millennium Oak

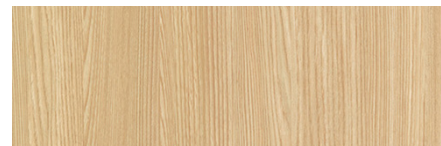

Natural Ash

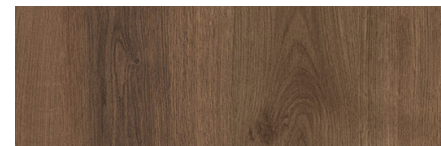

Planked Coffee Oak

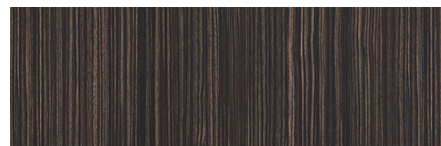

Ebony

Color images above are for reference only. Please verify with actual color sample.

**FINISHES**

**PAILO FINISHES**

**EDGE FINISHES – For use on Laminate (Edge 33) tops only**

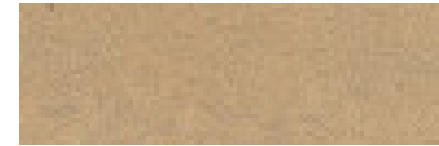

Clear (standard)

Ref Group Number 33

1" Laminate (Edge 33) tops are finished with a square edge that is clear finished as standard.



**LEG COLORS**



Matte Clear Finish



Black Stain

**FRAME FINISHES**

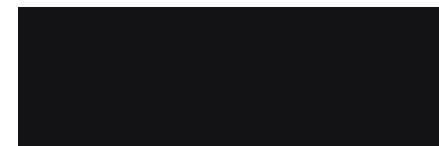

Black



White

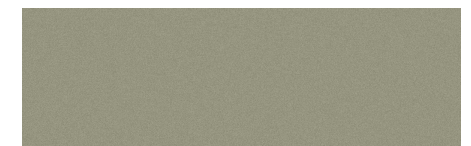

Pistachio



Totally Orange



Peacock Blue

Color images above are for reference only. Please verify with actual color sample.

**PAILO FINISHES**

**VERTICAL CABLE RISER FABRICS**



Black

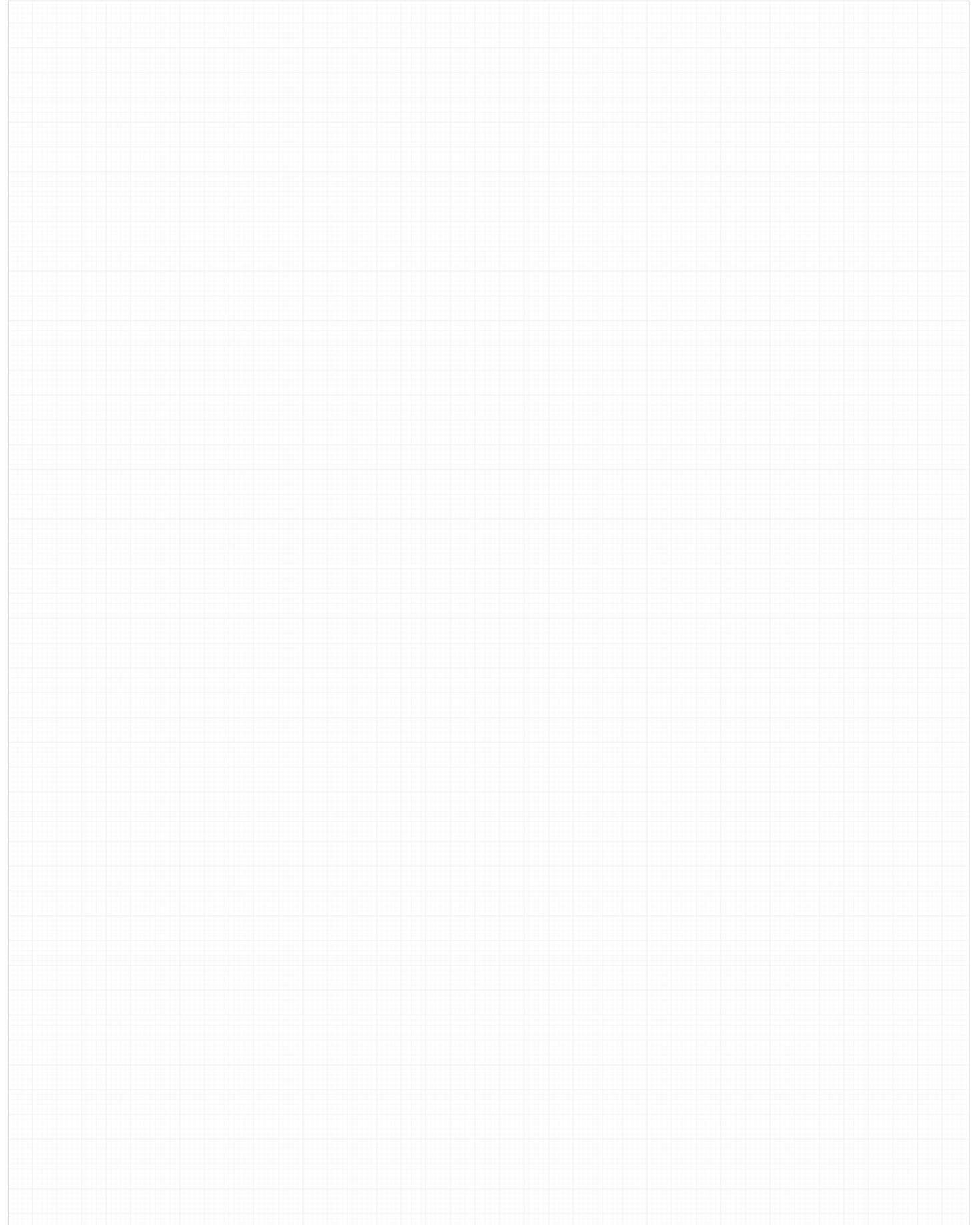

Color images above are for reference only. Please verify with actual color sample.