

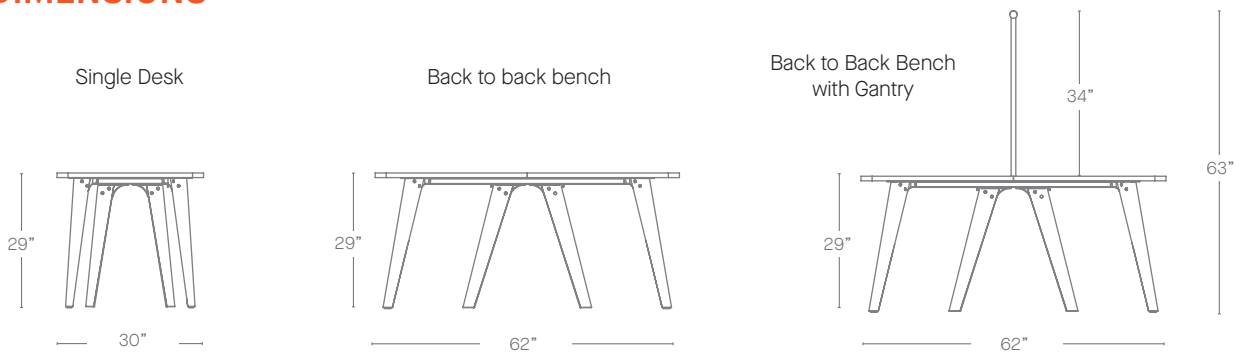

PAILO

Pailo provides a solution for both formal and informal working styles, taking a softer approach to the more formal bench desking systems.

DIMENSIONS



DESIGN

Senator

Our team of talented in house designers are responsible for creating elegant, innovative furniture designs which not only look beautiful, but minimise the impact on the world around us.

They come from all over the world, but are based in our Design Centre located in a quiet Lancashire village just outside the Ribble Valley. Our dedicated facility is over three floors which include studios, a materials test centre and prototyping lab.

STANDARD FEATURES (*Selected models only)

- Solid Ash sculpted legs
- Tooled Aluminum components
- Hidden frame attachments
- Leveling feet
- Scalloped cable access
- 1" TFL table tops (Edge 69), or 1" Laminate on ply tops (Edge 33)

SPECIFIABLE FEATURES

- In-line or back to back frames

COMPLEMENTARY OPTIONS

- Desk gantry for hanging lights and screens
- Adjustable drape screens
- Hanging screens
- Bench desk cloud screens
- Single desk cloud screens (integrated)

modesty panel)

- Suspended lighting
- In-desk power modules for project tables
- Cable trays in accent colors
- Wire under-desk storage caddy
- Vertical cable riser

OPTIONAL ACCESSORIES

- Monitor arms
- PU Desk accessories
- Desk Top accessories
- CPU Holders
- Electrical accessories

PERFORMANCE STANDARDS

Designed to conform to and where applicable is tested to the following standards:

- BIFMA X5.5 × 2014

DIMENSIONS



Single executive desk
Widths. 48"–78"
Depths. 30"



Single alone desk
Widths. 48"–78"
Depths. 30"



In-line desk
Widths. 48"–78"
Depths. 30"

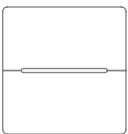

2 Person
Widths. 48"–78"
Depths. 62"



4 Person
Widths. 48"–78"
Depths. 62"

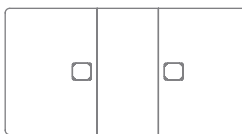

Project Table
Widths. 96"–192"
Depths. 62"

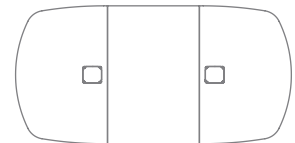

Boat Shaped Project Table
Widths. 96"–192"
Depths. 72"

FINISH OPTIONS

Tops are available in a range of TFL finishes from The Senator Group standard collection.

Edge 69 tops come standard with matching edge banding.

STANDARD TOP FINISHES - TFL



Carini Walnut



Autumn



Strata Oak



Urban Maple



Highland Oak

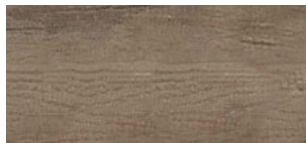

Winter Oak

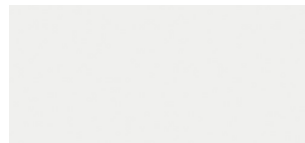

White



Light Gray



Denim

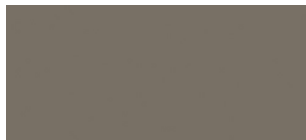

Clay

GLOBAL LAMINATES



Fog

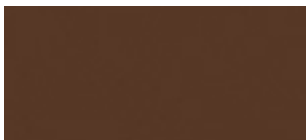

Dark Chocolate



Fossil

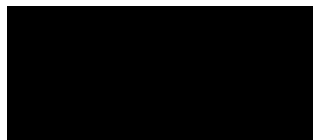

Diamond Black



Mouse



Sarum Gray



Storm

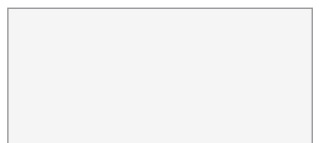

Brite White

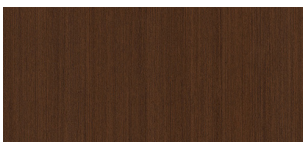

Chestnut Woodline

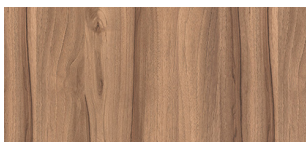

Oiled Walnut

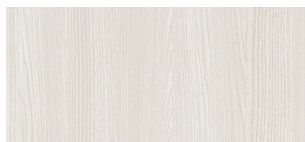

White Ash

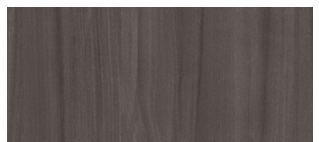

Smoky Brown Pear

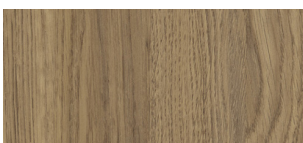

Millennium Oak



Natural Ash



Planked Coffee Oak

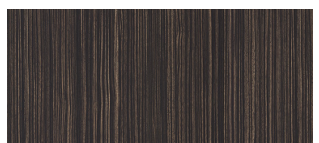

Ebony

CONTRASTING EDGE BANDS

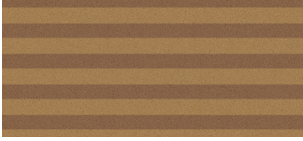

Ply Effect Edging

All TFLs are available with matching edge tape as standard. Contrasting edge tape can be specified.

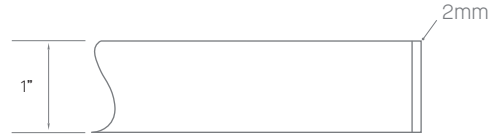

LEG FINISHES



Matte Clear Finish



Black Stain

EDGE STAINS



Clear (Standard)

Ref Group Number 33
1" Laminate (Edge 33) tops are finished with a square edge that is clear finished as standard.



METAL FINISHES

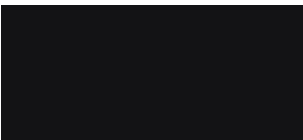

Black



White

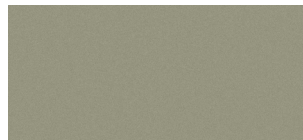

Pistachio



Totally Orange



Peacock Blue

VERTICAL CABLE RISER FABRICS

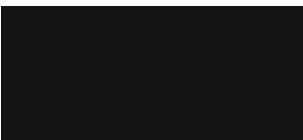

Black

MATERIAL CONTENT

Components are constructed of the following

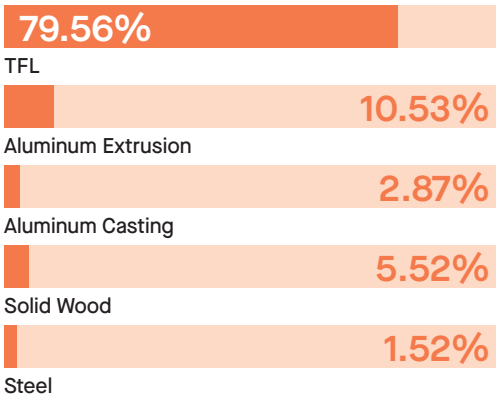

RECYCLED CONTENT

Contains up to 51.00% of Recycled Material

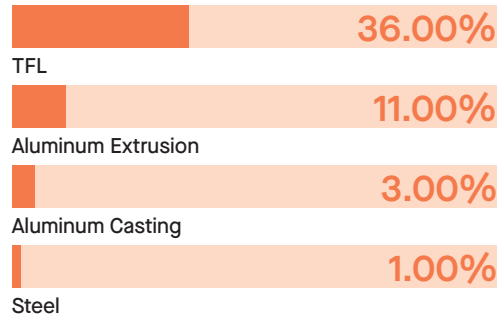

RECYCLABILITY

The range is 99% recyclable

99%

SKA Accreditation

EPA's to ISO14025, FSC and FISP accreditation are available for all product on request.

SENATOR 3 R'S

Senator is committed to continually improving the sustainability of all environmental aspects within our business.

To meet both international standards and our own environmental targets we apply the three R's principle

-Reduce, Reuse and Recycle.

While recycling is the element which

receives the most exposure it is actually the last option available and should never be the prime target in anyone's battle to reduce waste.

It is our duty as individuals and as a company to initially attempt to **Reduce** usage. Then we should look to **Reuse** wherever possible and finally, only after these two processes have been exhausted, should we consider **Recycling**.

REDUCE REUSE RECYCLE