

SENATOR

CHEMISTRY

CHEMISTRY FIXED HEIGHT

STANDARD FEATURES

- 2" square Steel tube legs with seamless mitred corners
- 1/4" shadow gap between top and frame
- Universally sized Steel dual crossrails
- Adjustable leveling feet
- Scalloped cable access
- 1" TFL rectangular tops or 1" TFL 120° tops

SPECIFIABLE FEATURES

- In-line or back to back frames

OPTIONAL FEATURES

- Rectangular desk end meeting tops
- Desk end storage
- Rectangular returns
- Universal screens
- Height adjustable blocks for fixed desk
- Modesty panels
- Hinged cable trays
- Single cable riser, mid leg cable riser, and double cable risers.

OPTIONAL ACCESSORIES

- Monitor arms
- PU Desk accessories
- Desk top accessories
- CPU holders
- Electrical accessories

PERFORMANCE STANDARDS

Designed to conform to and where applicable is tested to the following standards:

- BIFMA X5.5 x2014
- SCS-EC10.3-2014 v. 3.0 Indoor Advantage Gold

CHEMISTRY FIXED HEIGHT

Chemistry is a range of workstations designed to facilitate flexibility and diversity demanded by modern working environments. Twin beam design provides the modular bench system with additional rigidity for a well-supported work surface. Chemistry Fixed Height workstations are ordered as starter or as add on desks, available in stand alone, in-line or back to back configurations with a choice of leg styles, either goal post or 'O' legs.

DIMENSIONS

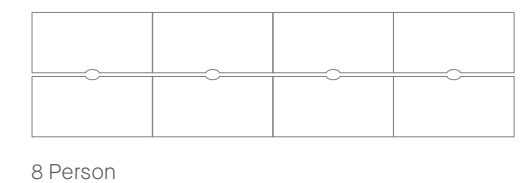
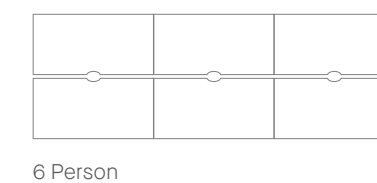
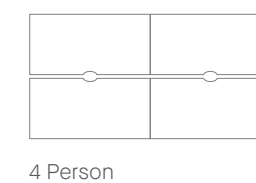
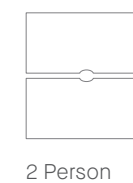
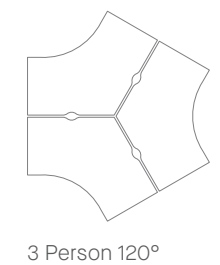
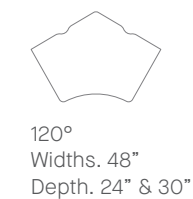
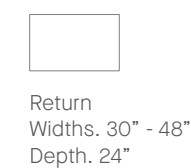
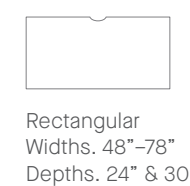
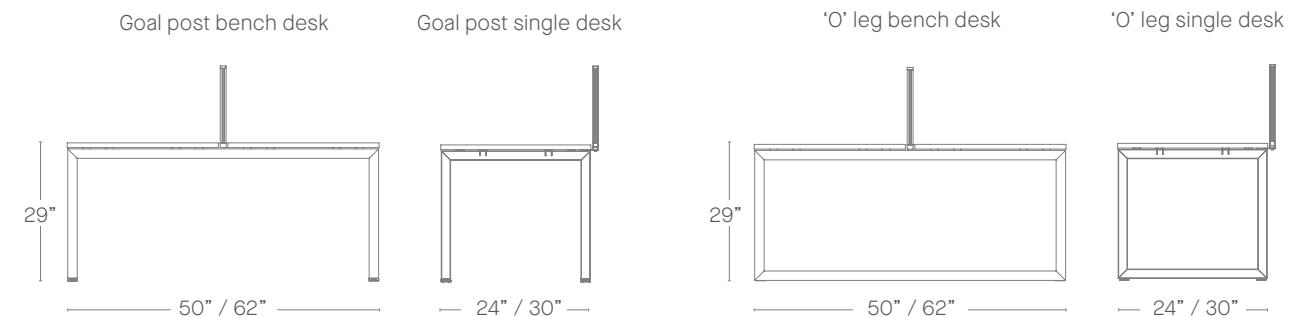

CHEMISTRY FIXED HEIGHT WITH GOAL POST LEG

● Available
□ Not available

Single Desk with Goal Post Leg
24" & 30" depths

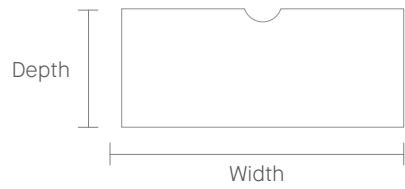

	48" W	54" W	60" W	66" W	72" W	78" W
24" D Starter	●	●	●	●	●	●
24" D Add on	●	●	●	●	●	●
30" D Starter	●	●	●	●	●	●
30" D Add on	●	●	●	●	●	●

Back to Back Bench with Goal Post Leg
50" & 62" depths

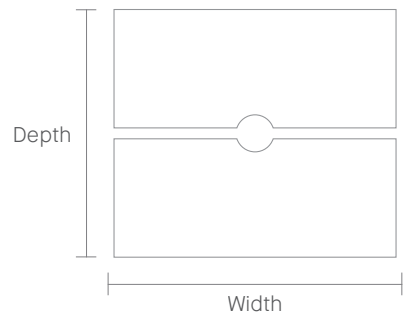

	48" W	54" W	60" W	66" W	72" W	78" W
50" D Starter	●	●	●	●	●	●
50" D Add on	●	●	●	●	●	●
62" D Starter	●	●	●	●	●	●
62" D Add on	●	●	●	●	●	●

Desk Return with Goal Post Leg



	30" W	36" W	42" W	48" W
24" D	●	●	●	●

CHEMISTRY FIXED HEIGHT WITH GOAL POST LEG

● Available
□ Not available

Modesty Panel



	48" W	54" W	60" W	66" W	72" W	78" W
Fixed (14.5" high)	●	●	●	●	●	●

120° Single Desk with Goal Post Leg

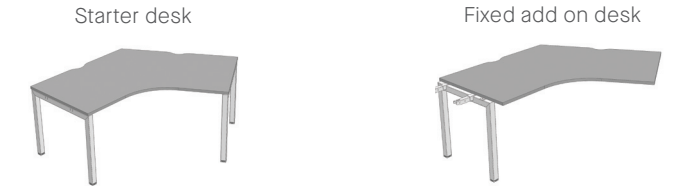
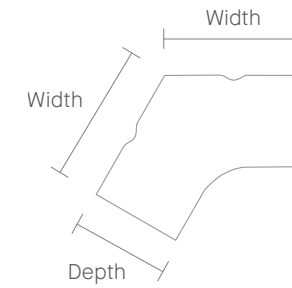

	48" W
24" D	●
30" D	●

120° 3 Person Cluster with Goal Post Leg

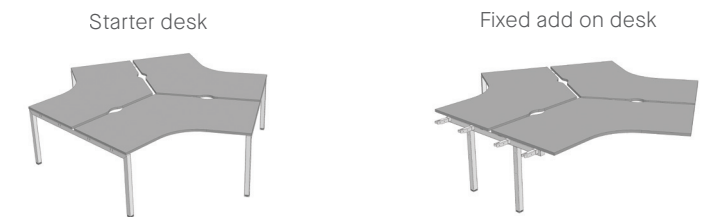
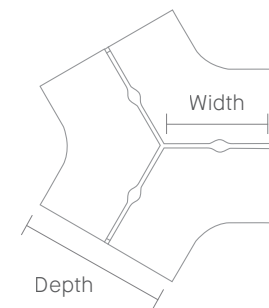

	48" W
50" D	●
62" D	●

STATEMENT OF LINE

CHEMISTRY FIXED HEIGHT WITH 'O' LEG

● Available
□ Not available

Single Desk with 'O' Leg
24" & 30" depths

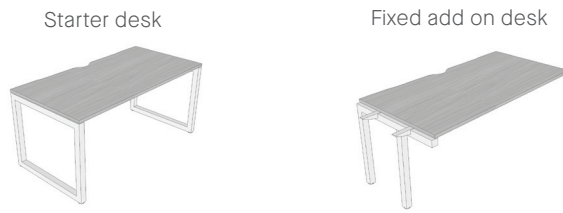
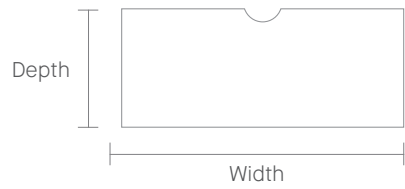

	48" W	54" W	60" W	66" W	72" W	78" W
24" D Starter	●	●	●	●	●	●
24" D Add on	●	●	●	●	●	●
30" D Starter	●	●	●	●	●	●
30" D Add on	●	●	●	●	●	●

Back to Back Bench with 'O' Leg
50" & 62" depths

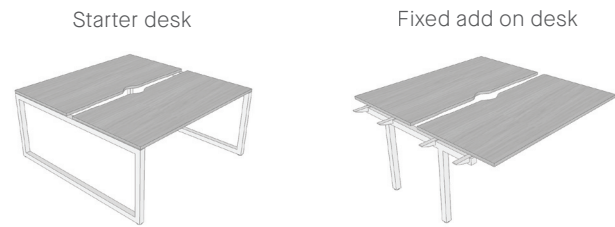
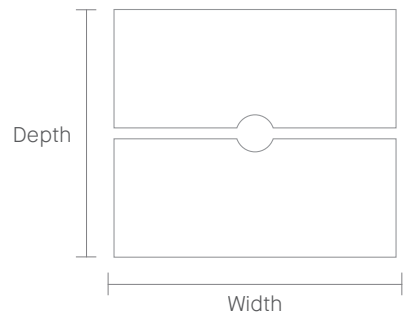

	48" W	54" W	60" W	66" W	72" W	78" W
50" D Starter	●	●	●	●	●	●
50" D Add on	●	●	●	●	●	●
62" D Starter	●	●	●	●	●	●
62" D Add on	●	●	●	●	●	●

Desk Return with 'O' Leg



	30" W	36" W	42" W	48" W
24" D	●	●	●	●

STATEMENT OF LINE

CHEMISTRY FIXED HEIGHT WITH 'O' LEG

● Available
□ Not available

Modesty Panel



	48" W	54" W	60" W	66" W	72" W	78" W
Fixed (14.5" high)	●	●	●	●	●	●

120° Single Desk with 'O' Leg

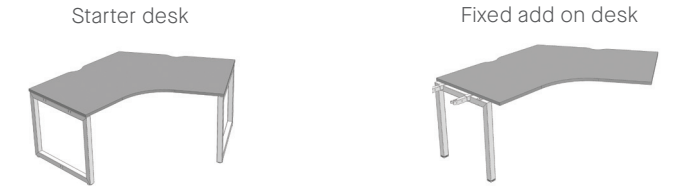
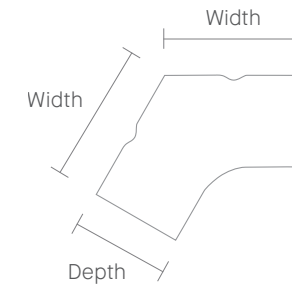

	48" W
24" D	●
30" D	●

120° 3 Person Cluster with 'O' Leg

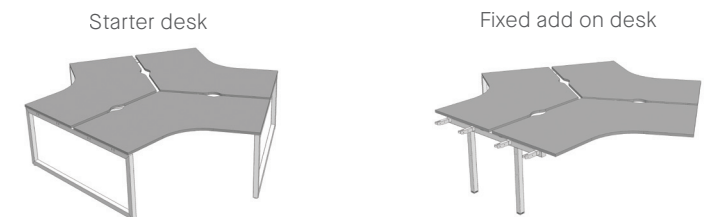
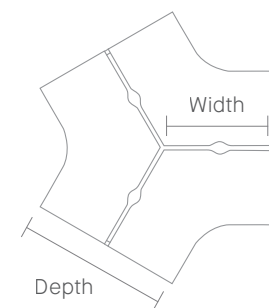

	48" W
50" D	●
62" D	●

CHEMISTRY GOAL POST & 'O' LEG FIXED HEIGHT

● Available
 □ Not available

Height Adjuster Blocks



Set of desk height adjustment blocks. Available in 1", 2" and 3".

1" H	2" H	3" H
●	●	●

Cable Trays



Single cable tray

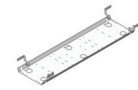

Double cable tray

39" W	48" W	54" W	60" W	66" W	72" W	78" W
●	●	●	●	●	●	●

Cable Risers

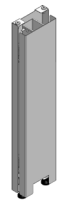

Single cable riser

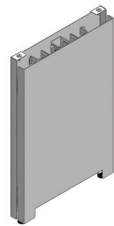

Double cable riser

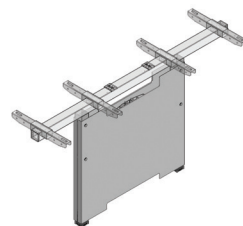

Mid leg cable riser

CHEMISTRY GOAL POST & 'O' LEG FIXED HEIGHT

● Available
 □ Not available

Executive Desk with Goal Post Leg

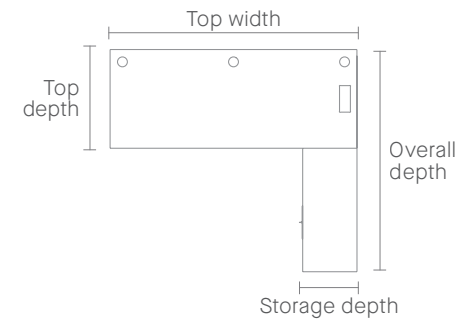

Top depth 30"
 Overall depth 74"



Top depth 30"
 Overall depth 74"



	72" W	78" W
18" D Storage	●	●
24" D Storage	●	●

Comes complete with modesty panel, integrated cable management, and letter filing

Executive Desk with 'O' Leg

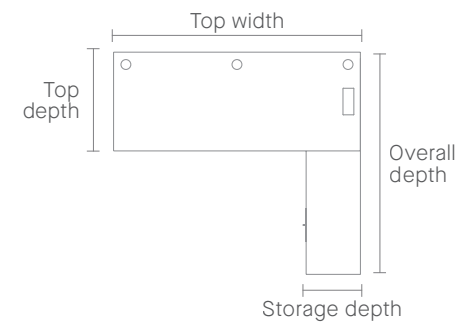

Top depth 30"
 Overall depth 74"



Top depth 30"
 Overall depth 74"



	72" W	78" W
18" D Storage	●	●
24" D Storage	●	●

Comes complete with modesty panel, integrated cable management, and letter filing

CHEMISTRY SINGLE FIXED HEIGHT DESK

STARTER DESK

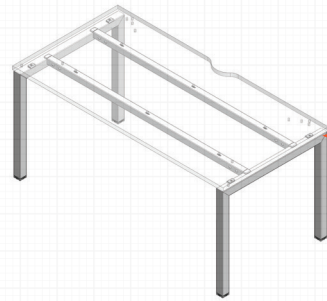

In-line benches are created by connecting an add on desk to a starter desk. You are able to link as many add on desks as necessary to complete your configuration.

End Leg

A starter desk is comprised of (2) end legs, (2) beams, (1) worksurface with scallop and all corresponding hardware and plastic components.

ADD ON DESK

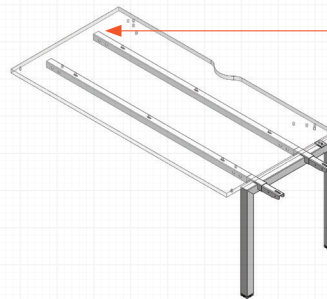

Beams

An add on desk is comprised of (1) mid leg, (2) beams, (1) worksurface with scallop and all corresponding hardware and plastic components.

Mid Leg

To link an add on desk to a starter desk (1) end leg from the starter desk is moved to the end of the run and the mid leg is placed in between.

BENCH WITH CABLE MANAGEMENT

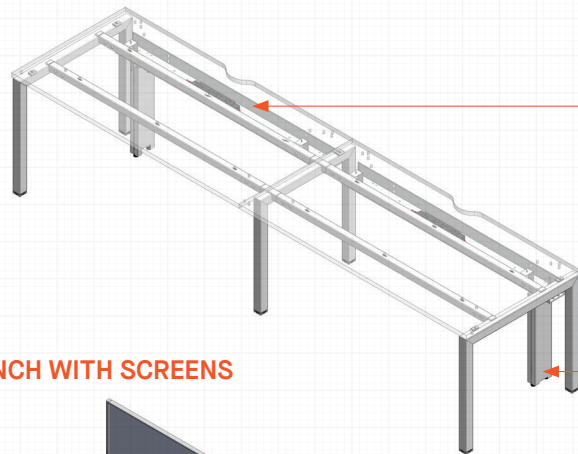

Cable Tray

Cable trays are available to manage power options. (1) single cable tray is needed per starter desk and every additional add on.

Single Cable Riser

The single leg vertical riser is used to transport power cables from the ground to the cable tray. It is attached to the underside of the cable tray and can be positioned at either end for central desk or end desk fed power.

BENCH WITH SCREENS

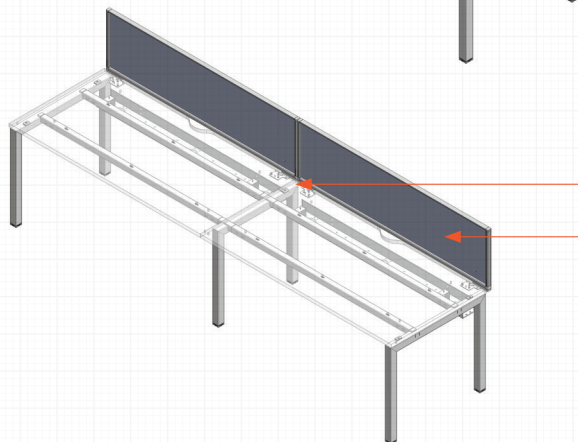

Desk Mounted Screens

Screens are available to separate desks to allow for more privacy. The screens are available with or without a frame.

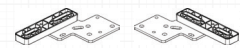

Single desk screen fixing bracket pack

Comprising of two brackets. To be used with framed desk mounted screens only.

Please note screen brackets required are CHF BKT1

WORK SURFACES

On single benches one top is supplied per starter or add on desk.

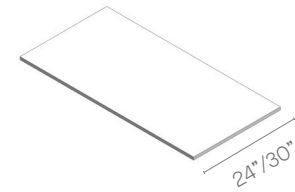

Chemistry tops are available in 24" or 30" depths and lengths of 48", 54", 60", 66", 72", and 78".

Tops are available in TFL with a scallop in the back for cable access.

TFL tops have a 2mm laser edge band all around.

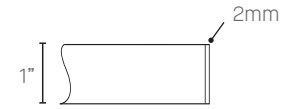

FRAMEWORK

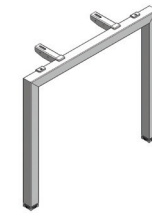

Goal Post End Legs

Single End Legs are 24" or 30" wide. Each end leg has spigots protruding from the frame to allow the beam to be bolted into place. Adjustable feet come standard.



Goal Post Leg Returns

Chemistry returns attach to the desk framework to add additional work space. They are available at a depth of 24" and at lengths of 30", 36", 42", and 48".

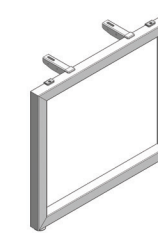

'O' Leg End Legs

Single End Legs are 24" or 30" wide. Each end leg has spigots protruding from the frame to allow the beam to be bolted into place. Adjustable feet come standard.



'O' Leg Returns

Chemistry returns attach to the desk framework to add additional work space. They are available at a depth of 24" and at lengths of 30", 36", 42", and 48".

FRAMEWORK

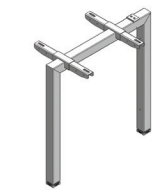

Mid Legs

Mid legs are used to connect starter desks and add on desks. They have double sided spigots to attach beams to both sides. Adjustable feet come standard.



Beams

Beams are metal box tubes used to connect the legs together. They bolt at each end to the spigots and also through to the top. Beams come in lengths of 48", 54", 60", 66", 72", and 78".

SCREENS

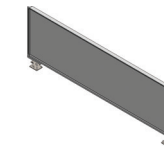

Available to provide more privacy and hang accessories. The screens are attached at the back of the desk underneath the top.

Fabric, TFL, and acrylic screen options are available. Screens also come in desk end and floor standing configurations.

MODESTY PANEL

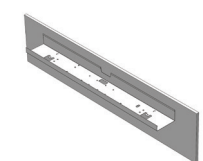

The Modesty Panel is a 3/4" thick TFL panel that is attached to the front framework to provide visual privacy below the work surface. The Modesty Panel comes complete with a cable tray for wire management and organization.

CABLE MANAGEMENT

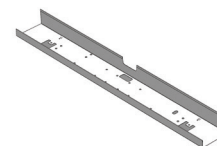

Cable Trays

Power blocks are bolted / screwed directly to the tray. Helps to improve safety and keep the under desk space tidy.



Single Cable Risers

Steel cable risers are used with cable trays and attached to either end of the tray. Allows power cables to be taken neatly up from the floor

CHEMISTRY EXECUTIVE DESKING – STORAGE



18" deep storage unit comes complete with 1x personal drawer, 1x filing drawer and open storage with shelves.



24" deep storage unit comes complete with 1x personal drawer, 1x filing drawer, open storage with shelves and a cubby for desktop computers with port hole access.



Filing drawer comes complete with filing cradle to support letter filing.

CHEMISTRY BACK TO BACK FIXED HEIGHT BENCH

STARTER DESK



Back to back benches are created by connecting an add on desk to a starter desk. You are able to link as many add on desks as necessary to complete your configuration.

End Leg

A starter desk is comprised of (2) end legs, (4) beams, (2) work surfaces with scallops and all corresponding hardware and plastic components.

ADD ON DESK

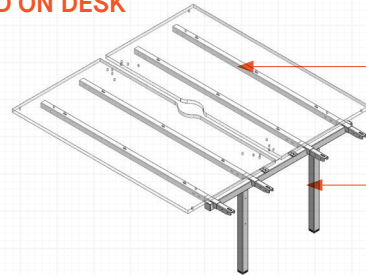

Beams

An add on desk is comprised of (1) mid leg, (4) beams, (2) work surfaces with scallop and all corresponding hardware and plastic components.

Mid Leg

To link an add on desk to a starter desk (1) end leg from the starter desk is moved to the end of the run and the mid leg is placed in between.

BENCH WITH CABLE MANAGEMENT

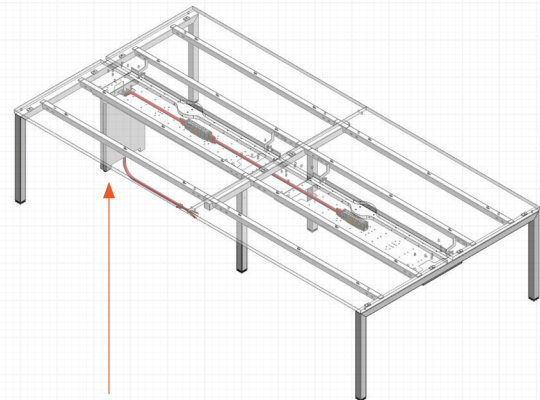

Double Cable Riser

The end leg vertical riser is used when power is fed from the end of the desk. The riser is bolted to the underside of the double cable tray.

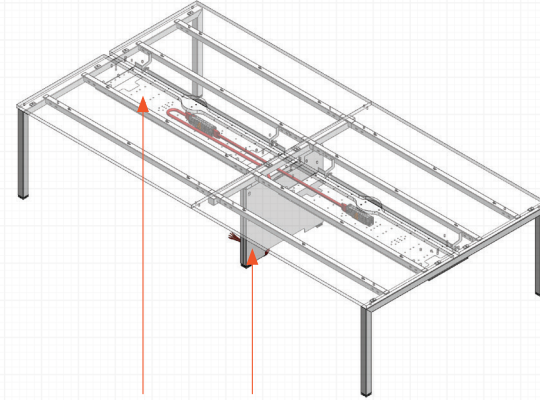

Cable Tray

Cable trays are available to manage power options. (1) double sided cable tray is needed per starter desk and every additional add on desk.

Mid Leg Riser

The mid leg cable riser is used when power is fed from the center of the desk. The riser attaches around the mid leg and hooks in place.

BENCH WITH SCREENS

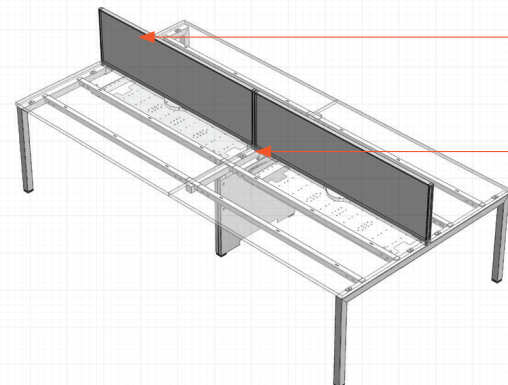

Desk Mounted Screens

Screens are available to separate desks to allow for more privacy. The screens are available with or without a frame.



Back to back bench screen fixing bracket pack

Comprising of two brackets. To be used with framed desk mounted screens only.

Please note screen brackets required are CHFBKT2

WORK SURFACES

On back to back benches two tops are supplied. Back to back configurations will result in 50"/62" overall depths due to the 2" central gap for cable access.

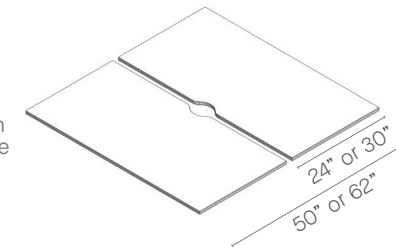

Chemistry tops are available in 24" or 30" depths and lengths of 48", 54", 60", 66", 72", and 78".

Tops are available in TFL with a scallop in the back for cable access.

TFL tops have a 2mm laser edge band all around.

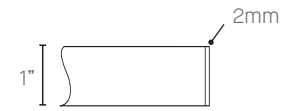

FRAMEWORK

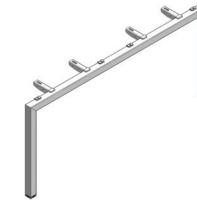

Goal Post End Legs

End Legs are 50" or 62" wide. Each End leg has spigots protruding from the frame to allow the beams to be bolted into place. Adjustable feet come standard.

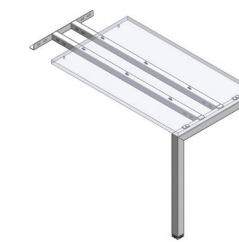

Chemistry Returns

Chemistry returns attach to the desk framework to add additional work space. They are available at a depth of 24" and at lengths of 30", 36", 42", and 48".

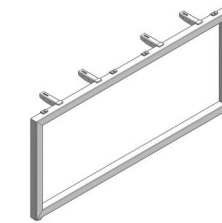

'O' Leg End Legs

End Legs are 50" or 62" wide. Each End leg has spigots protruding from the frame to allow the beams to be bolted into place. Adjustable feet come standard.



'O' Leg Returns

Chemistry returns attach to the desk framework to add additional work space. They are available at a depth of 24" and at lengths of 30", 36", 42", and 48".

FRAMEWORK



Mid Legs

Mid legs are used to connect starter desks and add on desks. They have double sided spigots to attach beams to both sides and come with adjustable feet as standard.



Beams

Beams are metal box tubes used to connect the legs together. They bolt at each end to the spigots and also through to the top. Beams come in lengths of 48", 54", 60", 66", 72", and 78".

SCREENS

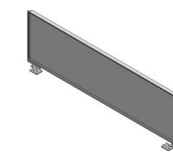

Available to provide more privacy and hang accessories. The screens are attached at the back of the desk underneath the top.

Fabric, TFL, glass, and acrylic screen options are available. Screens also come in desk end and floor standing configurations.

CABLE MANAGEMENT

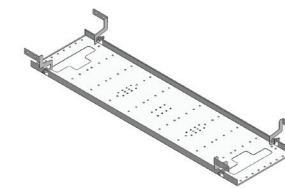

Double Cable Trays

Cable trays hang between the beams of the desk on brackets. These allow for the power blocks to be attached directly to the cable tray and house the loose cables.

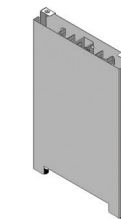

Double Cable Risers

End leg cable risers are used with cable trays and attached to the end of the tray. Allows power cables to be taken neatly up from the floor.

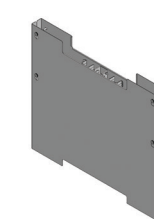

Double Cable Risers

When a mid leg is used an optional mid leg cable riser is available to transfer cables up to the center of the bench. This is clamped around each side of the mid leg to hide all cables inside.

CHEMISTRY 120° FIXED HEIGHT

STARTER DESK

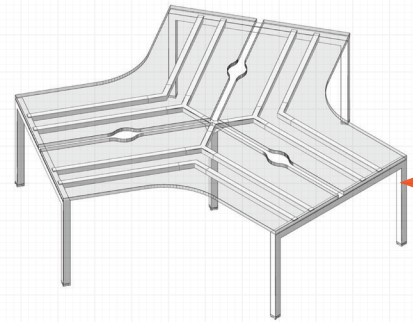
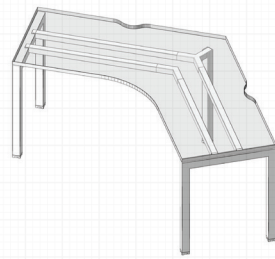

Both single desks and back to back benches are created by connecting an add on desk to a starter desk. You are able to link as many add on desks as necessary to complete your configuration.

End Leg

Single starter desks are comprised of (2) end legs, (1) post leg, (4) beams, (1) work surface with scallops, and all corresponding hardware and plastic components.

Back to back starter desks are comprised of (3) end legs, (1) post leg, (12) beams, (3) work surface with scallops, and all corresponding hardware and plastic components.

ADD ON DESK

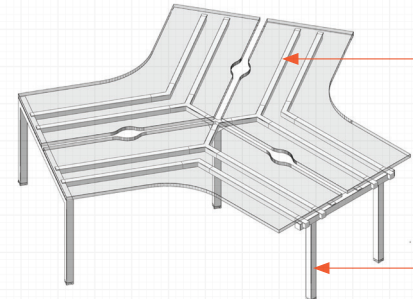
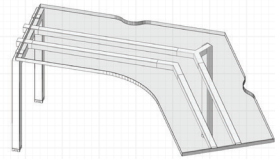

Beams

Single add on desks are comprised of (1) mid leg, (1) post leg, (4) beams, (1) work surface with scallops and all corresponding hardware and plastic components.

Back to back add on desks are comprised of (1) mid leg, (1) end leg, (1) post leg, (12) beams, (3) work surfaces with scallops and all corresponding hardware and plastic components.

Mid Leg

To link an add on desk to a starter desk (1) end leg from the starter desk is moved to the end of the run and the mid leg is placed in between.

CABLE MANAGEMENT

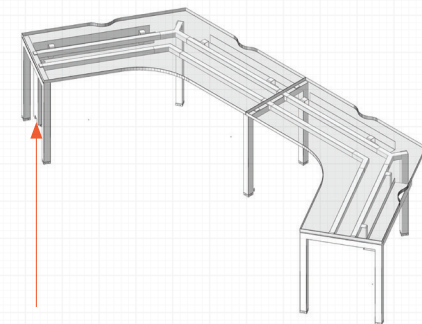

Cable Riser

The end leg vertical riser is used when power is fed from the end of the desk. The riser is bolted to the underside of the cable tray.

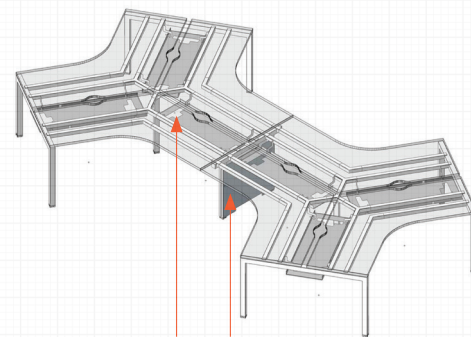

Cable Tray

Cable trays are available to manage power options. (3) double sided cable trays are needed per back to back starter desk and every additional add on desk.

Mid Leg Riser

The mid leg cable riser is used when power is fed from the center of the desk. The riser attaches around the mid leg and hooks in place.

BENCH WITH SCREENS

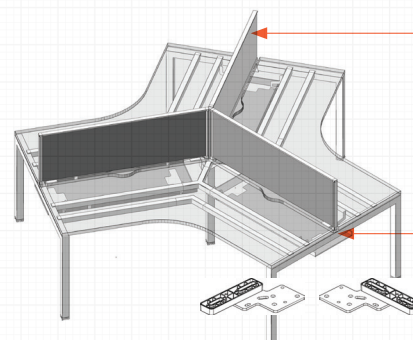
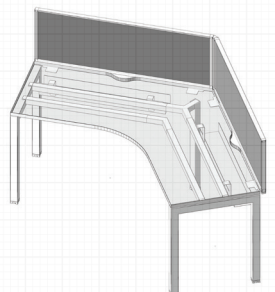

Desk Mounted Screens

Screens are available to separate desks to allow for more privacy. The screens are available with or without a frame.

Screen fixing bracket pack
Comprising of two brackets. To be used with framed desk mounted screens only.
Single desks require CHF BKT1
Back to back desks require CHF BKT2

WORK SURFACES

On 120 degree single desks, one top is supplied. For back to back benches, three tops are supplied.

Back to back configurations will result in 50"/62" overall depths due to the 2" central gap for cable access.

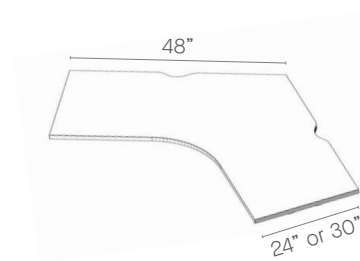

Chemistry 120 degree tops are available in 24" or 30" depths and come with a 48" length.

Tops are available in TFL with a scallop in the back for cable access.

TFL tops have a 2mm laser edge band all around.



FRAMEWORK

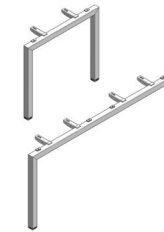

Goal Post End Legs

End Legs are 24" or 30" wide on single desks, and 50" or 62" wide on back to back desks. Each End leg has spigots protruding from the frame to allow the beams to be bolted into place. Adjustable feet come standard.

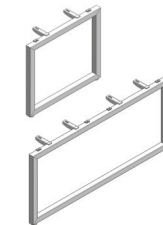

'O' Leg End Legs

End Legs are 24" or 30" wide on single desks, and 50" or 62" wide on back to back desks. Each End leg has spigots protruding from the frame to allow the beams to be bolted into place. Adjustable feet come standard.

FRAMEWORK



Mid Legs

Mid legs are used to connect starter desks and add on desks. They have double sided spigots to attach beams to both sides and come with adjustable feet as standard.

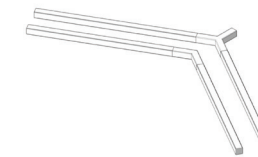

Beams

Beams are metal box tubes used to connect the legs together. They bolt at each end to the spigots and also through to the top.

SCREENS

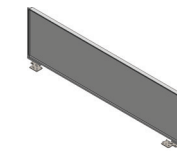

Available to provide more privacy and hang accessories. The screens are attached at the back of the desk underneath the top.

Fabric, TFL, and acrylic screen options are available on single desks and back to back benches. Screens also come in desk end and floor standing configurations. One 3 way linking post is recommended with each single or back to back desk when screens are specified.

CABLE MANAGEMENT

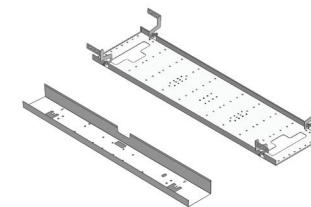

Cable Trays

Cable trays hang between the beams of the desk on brackets. These allow for the power blocks to be attached directly to the cable tray and house the loose cables.
On a single 120 degree desk, please specify two 39" single cable trays. If ordering a 120 degree back to back desk, please specify three 48" double cable trays.



Cable Risers

End leg cable risers are used with cable trays and attached to the end of the tray.
Allows power cables to be taken neatly up from the floor.

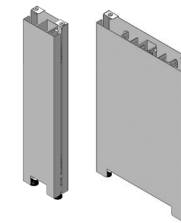

Mid Leg Cable Riser

On back to back benches when a mid leg is used, an optional mid leg cable riser is available to transfer cables up to the center of the bench.
This is clamped around each side of the mid leg to hide all cables inside.

CHEMISTRY SINGLE FIXED HEIGHT DESK

TYPICAL DESK WIRING LAYOUT

Suggested underframe wiring shown for goal post leg

*Other power configurations are available, please contact customer service for more details

Bench Size	8 Wire 4 Circuit
48"	EK48SB8W4C
54"	EK54SB8W4C
60"	EK60SB8W4C
66"	EK66SB8W4C
72"	EK72SB8W4C
78"	EK78SB8W4C

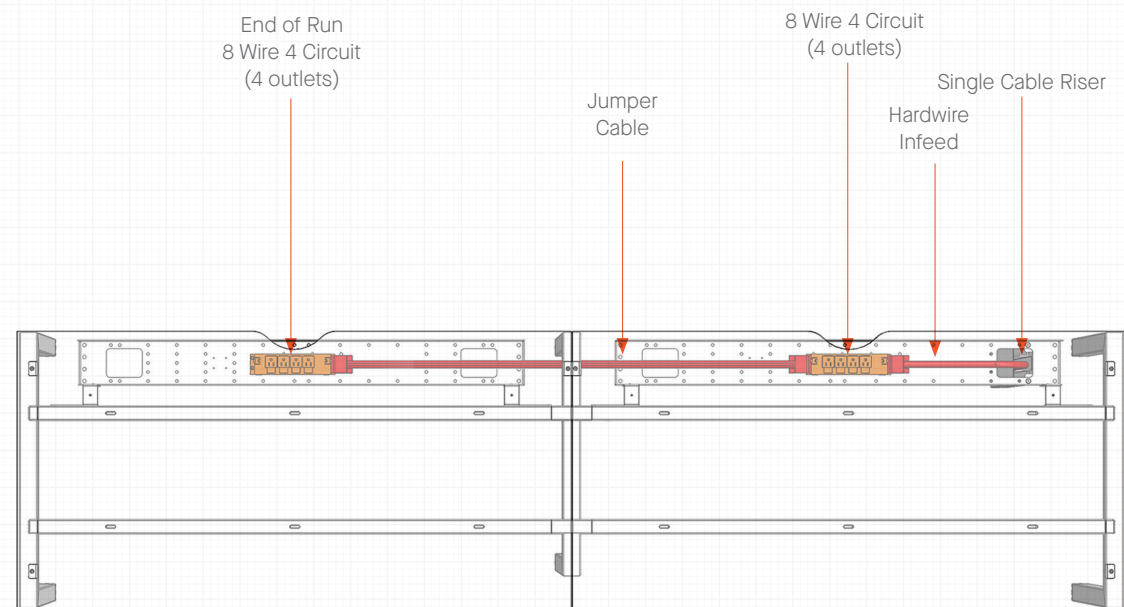
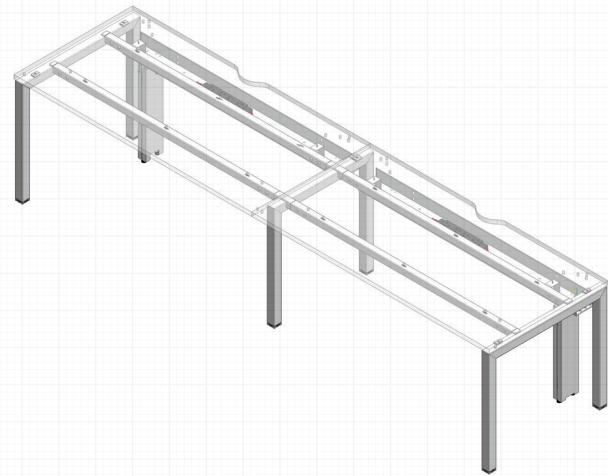
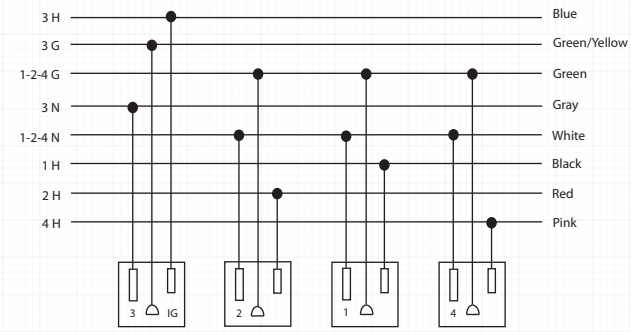

CHEMISTRY BACK TO BACK FIXED HEIGHT DESK

TYPICAL BACK TO BACK BENCH WIRING LAYOUT

Suggested underframe wiring shown for goal post leg

*Other power configurations are available, please contact customer service for more details

Bench Size	8 Wire 4 Circuit
48"	EK48DSB8W4C
54"	EK54DSB8W4C
60"	EK60DSB8W4C
66"	EK66DSB8W4C
72"	EK72DSB8W4C
78"	EK78DSB8W4C

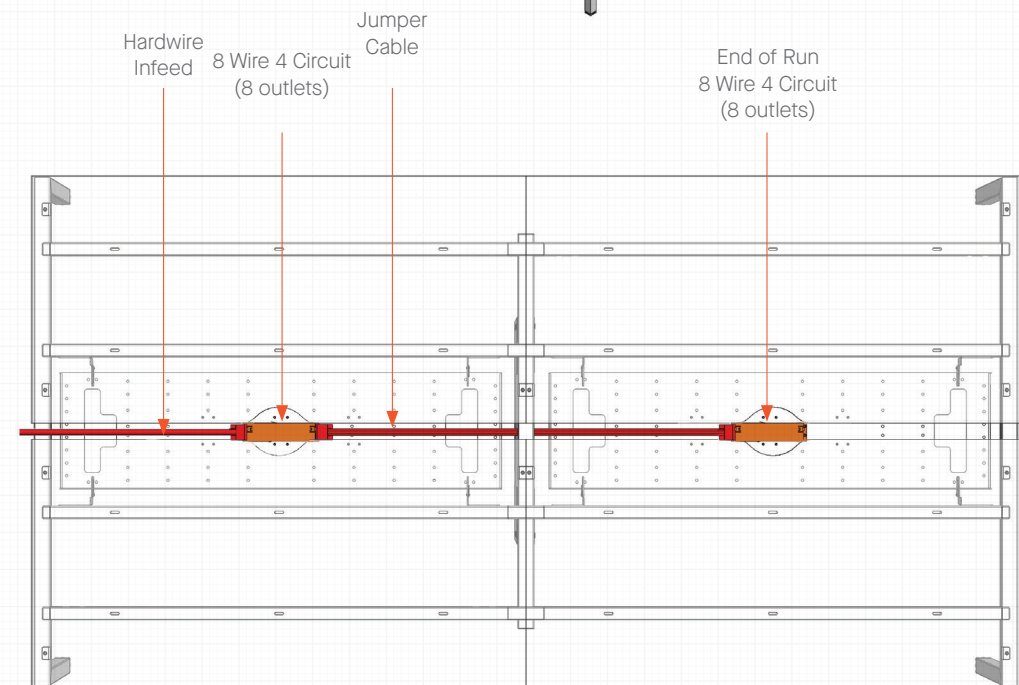
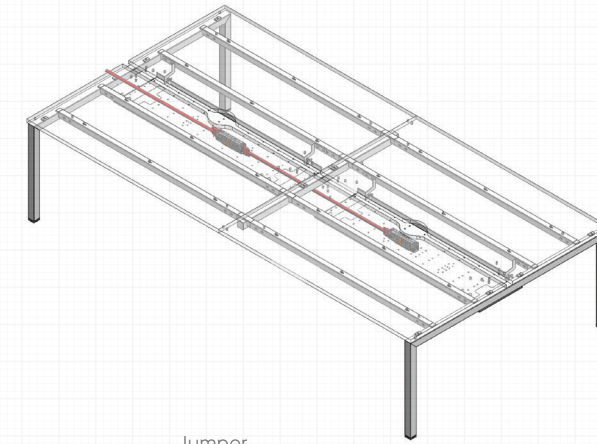
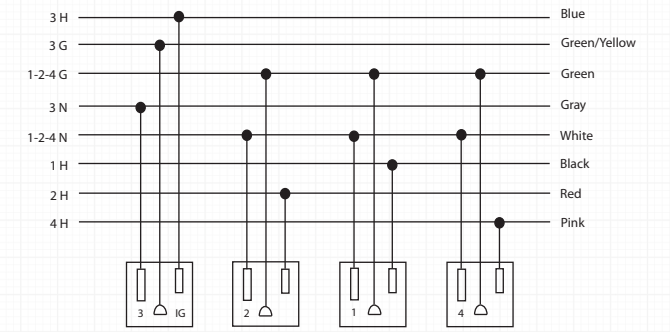

CHEMISTRY 120° SINGLE FIXED HEIGHT DESK

TYPICAL DESK WIRING LAYOUT

Suggested underframe wiring shown for goal post leg

*Other power configurations are available, please contact customer service for more details

Bench Size	8 Wire 4 Circuit
48"	EK48SB8W4C

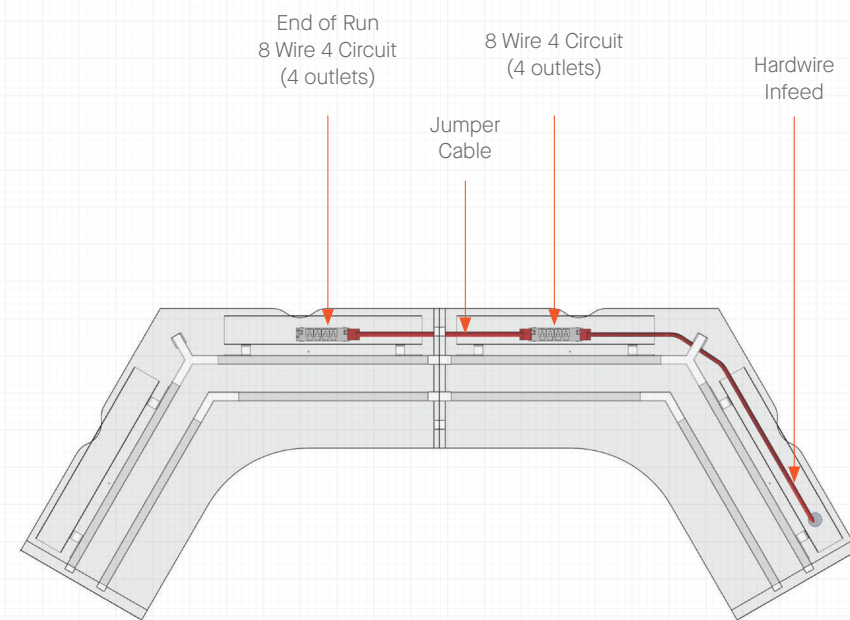
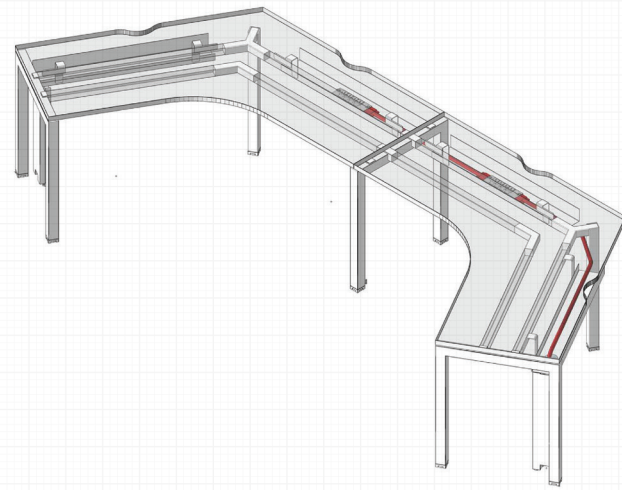
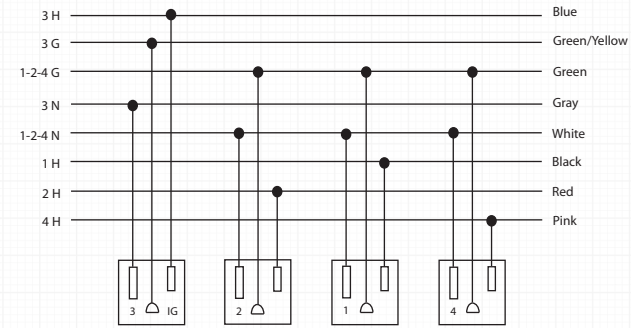

CHEMISTRY 120° BACK TO BACK FIXED HEIGHT DESK

TYPICAL BACK TO BACK BENCH WIRING LAYOUT

Suggested underframe wiring shown for goal post leg

*Other power configurations are available, please contact customer service for more details

Bench Size	8 Wire 4 Circuit
48"	EK48DSB8W4C

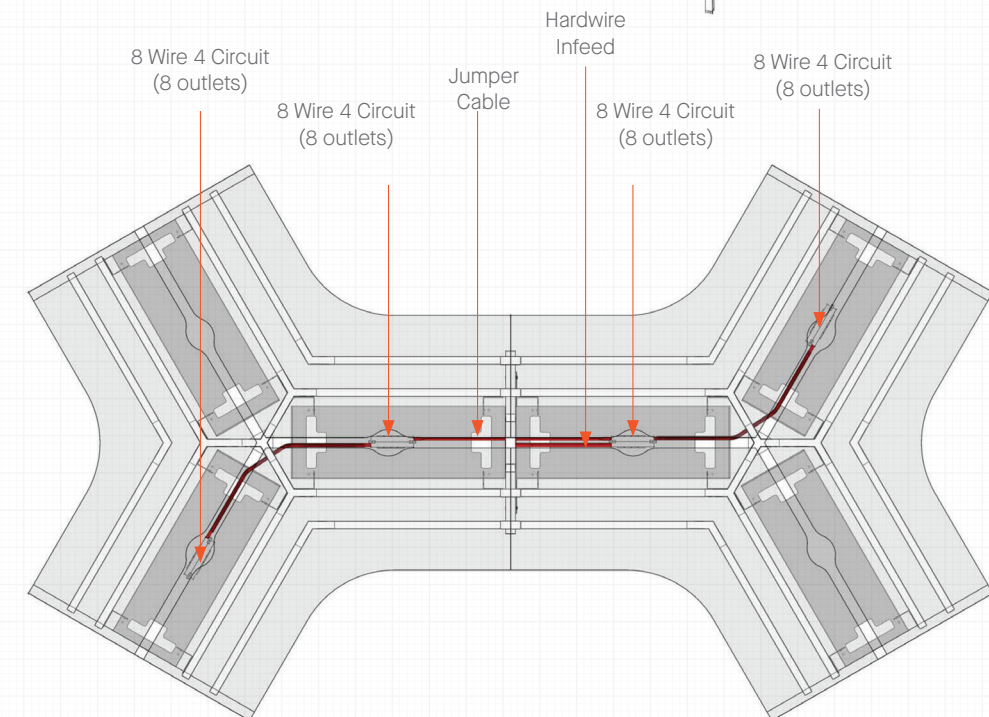
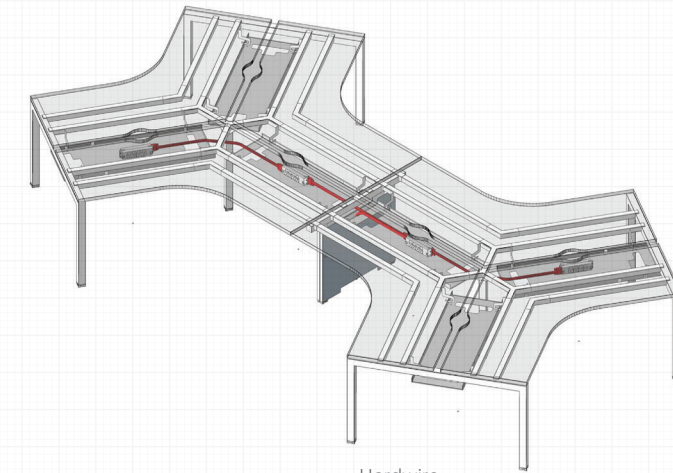
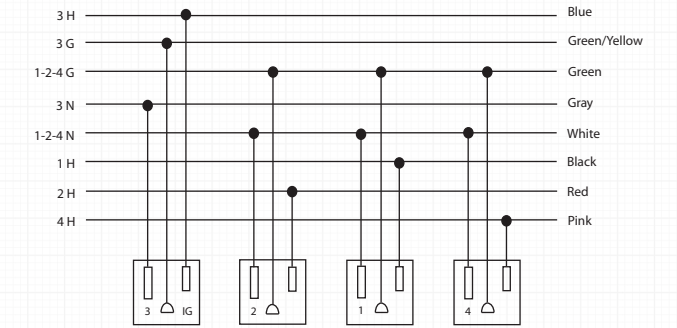

PRODUCT PRICING

SINGLE DESK – Goal Post Leg

	Width (inch)						Code
	48"	54"	60"	66"	72"	78"	
Starter Desk 24" Depth 	CH4824 1,407	CH5424 1,425	CH6024 1,437	CH6624 1,508	CH7224 1,528	CH7824 1,546	TFL
Add On Desk 24" Depth 	CH4824A 963	CH5424A 983	CH6024A 995	CH6624A 1,065	CH7224A 1,086	CH7824A 1,104	TFL
Starter Desk 30" Depth 	CH4830 1,438	CH5430 1,457	CH6030 1,472	CH6630 1,547	CH7230 1,569	CH7830 1,590	TFL
Add On Desk 30" Depth 	CH4830A 980	CH5430A 1,005	CH6030A 1,020	CH6630A 1,093	CH7230A 1,116	CH7830A 1,139	TFL
Single 120° Desk 24" Depth 	CH120S4824 2,058	-	-	-	-	-	TFL
Add On Single 120° Desk 24" Depth 	CH120S4824A 1,644	-	-	-	-	-	TFL
Single 120° Desk 30" Depth 	CH120S4830 2,121	-	-	-	-	-	TFL
Add On Single 120° Desk 30" Depth 	CH120S4830A 1,692	-	-	-	-	-	TFL

All prices listed in USD \$
 Ships KD = Knock Down (Assembly Required)

Finishes & Features Available...

TFL (1")	HD Highland Oak UM Urban Maple WH White WK Winter Oak SO Strata Oak CW Carini Walnut DN Denim LG Light Gray
Standard Top Features	Starter and Add on desks have scalloped cable access as standard Executive desks have a straight edge back edge as standard
Leg Colors	Silver White Black

PRODUCT PRICING

SINGLE DESK – Goal Post Leg

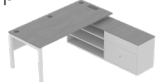
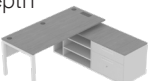

	Desk Top (inch)		Code
	72" x 30"	78" x 30"	
Executive Desk 18" Depth Storage 74" Overall Depth 	CH7230NS 5,743 SEE NOTES 1, 2, & 3	CH7830NS 5,873 SEE NOTES 1, 2, & 3	TFL
Executive Desk 24" Depth Storage 74" Overall Depth 	CH7230DS 5,873 SEE NOTES 1, 2, & 3	CH7830DS 5,980 SEE NOTES 1, 2, & 3	TFL

Note 1: All integrated cable management. All prices listed in USD \$
 Note 2: Please specify left (L) or right (R) hand version when ordering. (ie: CH7230NS-R) Ships KD = Knock Down (Assembly Required)
 Right hand shown.
 Note 3: For integrated port holes, please add an extra \$250. Port holes are located at the front left, center, and right of the desk. Add "P" to the end of the item code (ie: CH7230NSP-R)

To specify your desk...

1. Think through the configuration of Desk you require
2. Select the Codes of the individual items you need to achieve your configuration
3. Choose Finishes where appropriate: 'top' finishes / frame color / fabric color / acrylic color
4. Consider supporting product, screens, cable management and accessories

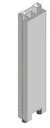

SINGLE DESK – Cable Management

		Width (inch)								
		39"	48"	54"	60"	66"	72"	78"	Code	Price
Single Cable Tray		CHCT39 252	CHCT48 267	CHCT54 291	CHCT60 321	CHCT66 340	CHCT72 350	CHCT78 368		
		SEE NOTES 1 & 2	SEE NOTE 2	SEE NOTE 2	SEE NOTE 2	SEE NOTE 2	SEE NOTE 2	SEE NOTE 2		
Single Cable Riser		CHCRS 262							Code	Price
		SEE NOTE 2								
Wooden Modesty w/ Cable Tray		CHMW120S48 502	CHMW48 594	CHMW54 624	CHMW60 656	CHMW66 676	CHMW72 700	CHMW78 731	Code	Price
		SEE NOTES 1 & 3	SEE NOTE 3	SEE NOTE 3	SEE NOTE 3	SEE NOTE 3	SEE NOTE 3	SEE NOTE 3		
CPU Holder Chemistry Desk		CHCPUH 242							Code	Price
		SEE NOTES 2 & 4								

Note 1: Only suitable for 120 degree desks
 Note 2: Available in Black, White, and Silver.
 Note 3: Available in all TFL finishes
 Note 4: Only suitable for 30" depth desks

All prices listed in USD \$
 Ships KD = Knock Down (Assembly Required)

SINGLE DESK – Height Adjustable Blocks

Set of Desk Height Adjustment Blocks 1" height 		Use on Fixed Heights only. 6 per set.	CHADJ1 78	Code	Price
			SEE NOTE 1		
Set of Desk Height Adjustment Blocks 2" height 		Use on Fixed Heights only. 6 per set.	CHADJ2 116	Code	Price
			SEE NOTE 1		
Set of Desk Height Adjustment Blocks 3" height 		Use on Fixed Heights only. 6 per set.	CHADJ3 146	Code	Price
			SEE NOTE 1		

Note 1: Available in Black, White, or Silver.

All prices listed in USD \$
 Ships KD = Knock Down (Assembly Required)

Finishes & Features Available...

TFL (1")	HD Highland Oak UM Urban Maple WH White WK Winter Oak SO Strata Oak CW Carini Walnut DN Denim LG Light Gray
Standard Top Features	Starter and Add on desks have scalloped cable access as standard Executive desks have a straight edge back edge as standard

To specify your desk...

1. Think through the configuration of Desk you require
2. Select the Codes of the individual items you need to achieve your configuration
3. Choose Finishes where appropriate: 'top' finishes / frame color / fabric color / acrylic color
4. Consider supporting product, screens, cable management and accessories

PRODUCT PRICING

BACK TO BACK BENCH – Goal Post Leg

		Width (inch)						
		48"	54"	60"	66"	72"	78"	
	Starter Bench 50" Depth	CHB4850 2,018	CHB5450 2,052	CHB6050 2,076	CHB6650 2,217	CHB7250 2,257	CHB7850 2,297	Code TFL
	Add On Bench 50" Depth	CHB4850A 1,379	CHB5450A 1,415	CHB6050A 1,438	CHB6650A 1,581	CHB7250A 1,620	CHB7850A 1,658	Code TFL
	Starter Bench 62" Depth	CHB4862 2,093	CHB5462 2,135	CHB6062 2,163	CHB6662 2,312	CHB7262 2,355	CHB7862 2,400	Code TFL
	Add On Bench 62" Depth	CHB4862A 1,427	CHB5462A 1,469	CHB6062A 1,497	CHB6662A 1,646	CHB7262A 1,690	CHB7862A 1,733	Code TFL
	120° Cluster Desk 50" Depth	CHB120W4850 5,300	-	-	-	-	-	Code TFL
	Add On 120° Cluster Desk 50" Depth	CHB120W4850A 4,681	-	-	-	-	-	Code TFL
	120° Cluster Desk 62" Depth	CHB120W4862 5,456	-	-	-	-	-	Code TFL
	Add On 120° Cluster Desk 62" Depth	CHB120W4862A 4,821	-	-	-	-	-	Code TFL

All prices listed in USD \$
Ships KD = Knock Down (Assembly Required)

Finishes & Features Available...

TFL (1")	HD Highland Oak UM Urban Maple WH White WK Winter Oak SO Strata Oak CW Carini Walnut DN Denim LG Light Gray
Standard Top Features	Starter and Add on desks have scalloped cable access as standard Executive desks have a straight edge back edge as standard
Leg Colors	Silver White Black

PRODUCT PRICING

BACK TO BACK BENCH – Cable Management

		Width (inch)						
		48"	54"	60"	66"	72"	78"	
	Double Cable Trays	CHDCT48 291	CHDCT54 317	CHDCT60 327	CHDCT66 340	CHDCT72 351	CHDCT78 374	Code Price
		SEE NOTES 1 & 2	SEE NOTE 2	SEE NOTE 2	SEE NOTE 2	SEE NOTE 2	SEE NOTE 2	
	Double Cable Riser	CHCRD 320						Code Price
		SEE NOTE 2						
	Mid Leg Cable Riser	CHLEGCM 378						Code Price
		SEE NOTE 2						
	CPU Holder Chemistry Desk	CHCPUH 242						Code Price
		SEE NOTES 2 & 3						

Note 1: When ordering 120 degree back to back desks, please specify 48" double cable tray
Note 2: Available in Black, White, and Silver.
Note 3: Only suitable for 30" depth desks

All prices listed in USD \$
Ships KD = Knock Down (Assembly Required)

To specify your desk...

1. Think through the configuration of Desk you require
2. Select the Codes of the individual items you need to achieve your configuration
3. Choose Finishes where appropriate: 'top' finishes / frame color / fabric color / acrylic color
4. Consider supporting product, screens, cable management and accessories

PRODUCT PRICING

SINGLE DESK – 'O' Leg

	Width (inch)						Code
	48"	54"	60"	66"	72"	78"	
Starter Desk 24" Depth 	CHO4824 1,565	CH05424 1,593	CH06024 1,606	CH06624 1,678	CH07224 1,696	CH07824 1,716	TFL
Add On Desk 24" Depth 	CH4824A 963	CH5424A 983	CH6024A 995	CH6624A 1,065	CH7224A 1,086	CH7824A 1,104	TFL
Starter Desk 30" Depth 	CHO4830 1,607	CH05430 1,638	CH06030 1,653	CH06630 1,726	CH07230 1,748	CH07830 1,772	TFL
Add On Desk 30" Depth 	CH4830A 980	CH5430A 1,005	CH6030A 1,020	CH6630A 1,093	CH7230A 1,116	CH7830A 1,139	TFL
Single 120° Desk 24" Depth 	CHO120S4824 1,772	-	-	-	-	-	TFL
Add On Single 120° Desk 24" Depth 	CH120S4824A 1,644	-	-	-	-	-	TFL
Single 120° Desk 30" Depth 	CHO120S4830 2,303	-	-	-	-	-	TFL
Add On Single 120° Desk 30" Depth 	CH120S4830A 1,692	-	-	-	-	-	TFL

All prices listed in USD \$



Ships KD = Knock Down (Assembly Required)

Finishes & Features Available...

TFL (1")	HD Highland Oak UM Urban Maple WH White WK Winter Oak SO Strata Oak CW Carini Walnut DN Denim LG Light Gray
Standard Top Features	Starter and Add on desks have scalloped cable access as standard Executive desks have a straight edge back edge as standard
Leg Colors	Silver White Black

PRODUCT PRICING

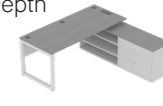
SINGLE DESK – 'O' Leg

	Desk Top (inch)		Code
	72" x 30"	78" x 30"	
Executive Desk 18" Depth Storage 74" Overall Depth 	CHO723ONS 5,847 SEE NOTES 1, 2, & 3	CH0783ONS 5,965 SEE NOTES 1, 2, & 3	TFL
Executive Desk 24" Depth Storage 74" Overall Depth 	CHO723ODS 5,988 SEE NOTES 1, 2, & 3	CH0783ODS 6,096 SEE NOTES 1, 2, & 3	TFL

Note 1: All integrated cable management.

All prices listed in USD \$



Note 2: Please specify left (L) or right (R) hand version when ordering. (ie: CHO723ONS-R) Ships KD = Knock Down (Assembly Required) Right hand shown.

Note 3: For integrated port holes, please add an extra \$250. Port holes are located at the front left, center, and right of the desk. Add "P" to the end of the item code (ie: CHO723ONSP-R)

To specify your desk...

1. Think through the configuration of Desk you require
2. Select the Codes of the individual items you need to achieve your configuration
3. Choose Finishes where appropriate: 'top' finishes / frame color / fabric color / acrylic color
4. Consider supporting product, screens, cable management and accessories

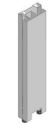
SINGLE DESK – Cable Management

		Width (inch)							
		39"	48"	54"	60"	66"	72"	78"	
Single Cable Tray		CHCT39 252	CHCT48 267	CHCT54 291	CHCT60 321	CHCT66 340	CHCT72 350	CHCT78 368	Code Price
		SEE NOTES 1 & 2	SEE NOTE 2	SEE NOTE 2	SEE NOTE 2	SEE NOTE 2	SEE NOTE 2	SEE NOTE 2	SEE NOTE 2
Single Cable Riser		CHCRS 262							Code Price
		SEE NOTE 2							
Wooden Modesty w/ Cable Tray		CHMW120S48 570	CHMW48 594	CHMW54 624	CHMW60 656	CHMW66 676	CHMW72 700	CHMW78 731	Code Price
		SEE NOTES 1 & 3	SEE NOTE 3	SEE NOTE 3	SEE NOTE 3	SEE NOTE 3	SEE NOTE 3	SEE NOTE 3	SEE NOTE 3
CPU Holder Chemistry Desk		CHCPUH 242							Code Price
		SEE NOTES 2 & 4							

Note 1: Only suitable for 120 degree desks
 Note 2: Available in Black, White, and Silver.
 Note 3: Available in all TFL finishes
 Note 4: Only suitable for 30" depth desks

All prices listed in USD \$
 Ships KD = Knock Down (Assembly Required)

SINGLE DESK – Height Adjustable Blocks

Set of Desk Height Adjustment Blocks 1" height		Use on Fixed Heights only. 6 per set.	CHADJ1 78	Code Price
			SEE NOTE 1	
Set of Desk Height Adjustment Blocks 2" height		Use on Fixed Heights only. 6 per set.	CHADJ2 116	Code Price
			SEE NOTE 1	
Set of Desk Height Adjustment Blocks 3" height		Use on Fixed Heights only. 6 per set.	CHADJ3 146	Code Price
			SEE NOTE 1	

Note 1: Available in Black, White, or Silver.

All prices listed in USD \$
 Ships KD = Knock Down (Assembly Required)

Finishes & Features Available...

TFL (1")	HD Highland Oak UM Urban Maple WH White WK Winter Oak SO Strata Oak CW Carini Walnut DN Denim LG Light Gray
Standard Top Features	Starter and Add on desks have scalloped cable access as standard Executive desks have a straight edge back edge as standard

To specify your desk...

1. Think through the configuration of Desk you require
2. Select the Codes of the individual items you need to achieve your configuration
3. Choose Finishes where appropriate: 'top' finishes / frame color / fabric color / acrylic color
4. Consider supporting product, screens, cable management and accessories

PRODUCT PRICING

BACK TO BACK BENCH – 'O' Leg

	Width (inch)						Code	TFL
	48"	54"	60"	66"	72"	78"		
Starter Bench 50" Depth 	CHOB4850 2,543	CHOB5450 2,578	CHOB6050 2,604	CHOB6650 2,745	CHOB7250 2,784	CHOB7850 2,822		
Add On Bench 50" Depth 	CHB4850A 1,379	CHB5450A 1,415	CHB6050A 1,438	CHB6650A 1,581	CHB7250A 1,620	CHB7850A 1,658		
Starter Bench 62" Depth 	CHOB4862 2,593	CHOB5462 2,635	CHOB6062 2,663	CHOB6662 2,813	CHOB7262 2,874	CHOB7862 2,901		
Add On Bench 62" Depth 	CHB4862A 1,427	CHB5462A 1,469	CHB6062A 1,497	CHB6662A 1,646	CHB7262A 1,690	CHB7862A 1,733		
120° Cluster Desk 50" Depth 	CHOB120W4850 6,021	-	-	-	-	-		
Add On 120° Cluster Desk 50" Depth 	CHOB120W4850A 5,280	-	-	-	-	-		
120° Cluster Desk 62" Depth 	CHOB120W4862 6,201	-	-	-	-	-		
Add On 120° Cluster Desk 62" Depth 	CHOB120W4862A 5,487	-	-	-	-	-		





All prices listed in USD \$
Ships KD = Knock Down (Assembly Required)

Finishes & Features Available...

TFL (1")	HD Highland Oak UM Urban Maple WH White WK Winter Oak SO Strata Oak CW Carini Walnut DN Denim LG Light Gray
Standard Top Features	Starter and Add on desks have scalloped cable access as standard Executive desks have a straight edge back edge as standard
Leg Colors	Silver White Black

PRODUCT PRICING

BACK TO BACK BENCH – Cable Management

	Width (inch)						Code	Price
	48"	54"	60"	66"	72"	78"		
Double Cable Trays 	CHDCT48 291 SEE NOTES 1 & 2	CHDCT54 317 SEE NOTE 2	CHDCT60 327 SEE NOTE 2	CHDCT66 340 SEE NOTE 2	CHDCT72 351 SEE NOTE 2	CHDC78 374 SEE NOTE 2		
Double Cable Riser 	CHCRD 320 SEE NOTE 2							
Mid Leg Cable Riser 	CHLEGCM 378 SEE NOTE 2							
CPU Holder Chemistry Desk 	CHCPUH 242 SEE NOTES 2 & 3							

Note 1: When ordering 120 degree back to back desks, please specify 48" double cable tray
Note 2: Available in Black, White, and Silver.
Note 3: Only suitable for 30" depth desks

All prices listed in USD \$
Ships KD = Knock Down (Assembly Required)

To specify your desk...

1. Think through the configuration of Desk you require
2. Select the Codes of the individual items you need to achieve your configuration
3. Choose Finishes where appropriate: 'top' finishes / frame color / fabric color / acrylic color
4. Consider supporting product, screens, cable management and accessories

BACK TO BACK BENCH – Desk Extensions / Storage Boxes

Desk Extension
16" Depth



	Width (inch)		Code
	50"	62"	
Can be used on Goal Post Legs and 'O' Legs.	CHDE50 583	CHDE62 600	TFL
Can be used on Goal Post Legs and 'O' Legs.	CHDESB50 1,165	CHDESB62 1,199	TFL

Desk Extension Storage Box
16" Depth x
16" Height



	Width (inch)				Code
	30"	36"	42"	48"	
Use on Fixed Heights only.	CHRTN30 1,026	CHRTN36 1,049	CHRTN42 1,062	CHRTN48 1,078	TFL
Use on Fixed Heights only.	CHORTN30 1,120	CHORTN36 1,144	CHORTN42 1,162	CHORTN48 1,172	TFL

All prices listed in USD \$
Ships KD = Knock Down (Assembly Required)

BACK TO BACK BENCH – Height Adjustable Blocks

Set of Desk Height Adjustment Blocks
1" height



Use on Fixed Heights only. 6 per set.	CHADJ1 78	Code Price
	SEE NOTE 1	
Use on Fixed Heights only. 6 per set.	CHADJ2 116	Code Price
	SEE NOTE 1	
Use on Fixed Heights only. 6 per set.	CHADJ3 146	Code Price
	SEE NOTE 1	

Set of Desk Height Adjustment Blocks
2" height



Set of Desk Height Adjustment Blocks
3" height



Note 1: Available in Black, White, or Silver.

All prices listed in USD \$
Ships KD = Knock Down (Assembly Required)

Finishes & Features Available...

TFL (1")	HD Highland Oak UM Urban Maple WH White WK Winter Oak SO Strata Oak CW Carini Walnut DN Denim LG Light Gray
Standard Top Features	Starter and Add on desks have scalloped cable access as standard Executive desks have a straight edge back edge as standard
Leg Colors	Silver White Black

To specify your desk...

1. Think through the configuration of Desk you require
2. Select the Codes of the individual items you need to achieve your configuration
3. Choose Finishes where appropriate: 'top' finishes / frame color / fabric color / acrylic color
4. Consider supporting product, screens, cable management and accessories

CHEMISTRY DESKTOP SCREENS

Desk Mounted Screens



	48" W	54" W	60" W	66" W	72" W	78" W
16" H	●	●	●	●	●	●

Desktop Frameless Screens for Single Desks

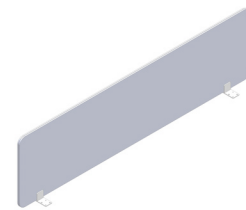

Desktop screen for single/inline height adjustable desk
16" high, complete with bracket

	48" W	54" W	60" W	66" W	72" W	78" W
16" H	●	●	●	●	●	●

Desk End Screens



	24" W	30" W	54" W	60" W	66" W	72" W	78" W
45" H	●	●	●	●	●	●	●

Desk End Screens



	24" W	30" W	54" W	60" W	66" W	72" W	78" W
55" H	●	●	●	●	●	●	●
62" H	●	●	●	●	●	●	●

CHEMISTRY DESKTOP SCREENS

Desk Divider Screens



	24" W	30" W
16" H	●	●

Glass Screen and Rail



Note: Only available for Back to Back benches

	48" W	54" W	60" W	66" W	72" W	78" W
16" H	●	●	●	●	●	●

Single Desk Screen Fixing Bracket Pack

Comprising of two brackets (Desk mounted screens only)

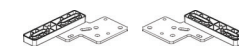

Back to Back Bench Screen Fixing Bracket Pack

Comprising of two brackets (Desk mounted screens only)



120 Degree 3 Way Linking Post

16" high



4 Way Linking Post With Adjustable Foot

45" high
55" high



Accessories



Pen pot with rail holder

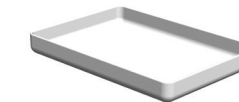

Paper tray

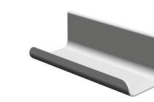

Pen tray

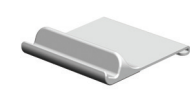

Tablet holder

TYPICAL CLUSTER DESK SET UP

4 person 60" x 30" workstation

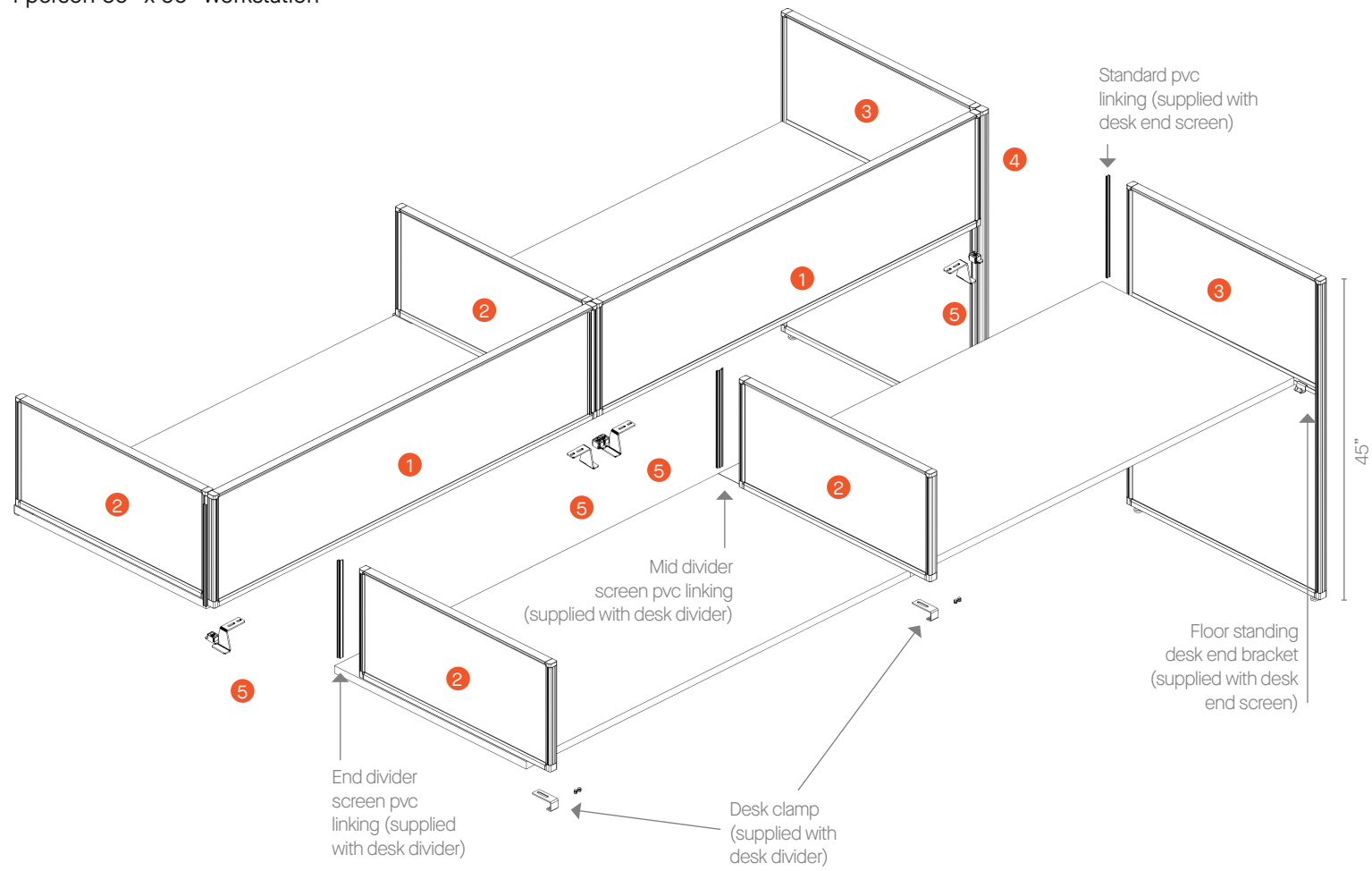



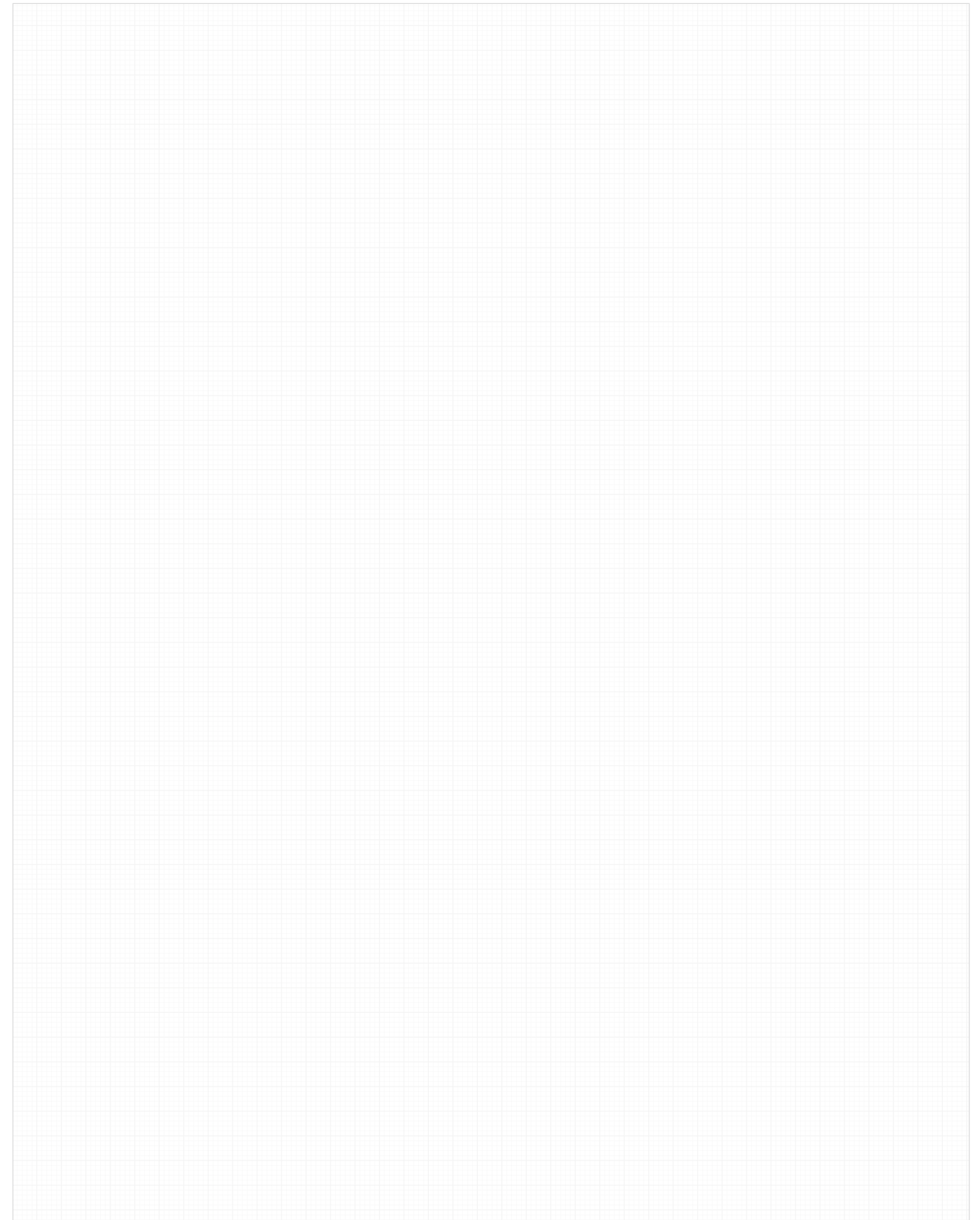

Code	Description	QTY
1	US1660 Universal desk mounted fabric screen Supplied with pvc linking	2
2	USDD1630 Universal desk mounted fabric divider/end screen Supplied with pvc linking and desk clamp	4
3	USDE4830 Universal desk end fabric floor standing screen Supplied with pvc linking, desk end bracket, and adjustable feet	2
4	US4WPST48 4-Way Linking Post Supplied with adjustable foot	1
5	CHFBKT2 Chemistry screen fixing bracket pack	2

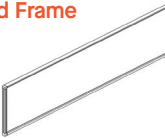

PRODUCT PRICING

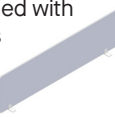
SCREENS – Desktop Screens



	Width (inch)						Code
	48" W	54" W	60" W	66" W	72" W	78" W	
Desk Screen with Standard Frame 16" High 	US1648	US1654	US1660	US1666	US1672	US1678	TFL
	428	447	464	506	520	541	Acrylic
	626	666	693	709	742	777	Grade A
	499	524	554	574	591	616	Grade B
	541	566	603	626	649	675	Grade C
639	674	723	761	791	824		
SEE NOTES 1 & 2	SEE NOTES 1 & 2	SEE NOTES 1 & 2	SEE NOTES 1 & 2	SEE NOTES 1 & 2	SEE NOTES 1 & 2	SEE NOTES 1 & 2	
Desk Screen with Single Tool Rail 16" High 	UST1648	UST1654	UST1660	UST1666	UST1672	UST1678	TFL
	419	461	479	518	533	554	Acrylic
	639	680	707	723	755	791	Grade A
	514	539	566	586	605	630	Grade B
	554	581	615	639	662	689	Grade C
653	687	738	775	806	839		
SEE NOTES 1 & 2	SEE NOTES 1 & 2	SEE NOTES 1 & 2	SEE NOTES 1 & 2	SEE NOTES 1 & 2	SEE NOTES 1 & 2	SEE NOTES 1 & 2	
Desktop Screen Frameless Non-Pinnable 16" High Supplied with Fixing Brackets 	CHPSF1648	CHPSF1654	CHPSF1660	CHPSF1666	CHPSF1672	CHPSF1678	Grade A
	472	482	497	510	527	537	Grade B
	510	522	545	560	581	596	Grade C
	605	626	660	682	718	739	
	SEE NOTE 2	SEE NOTE 2	SEE NOTE 2	SEE NOTE 2	SEE NOTE 2	SEE NOTE 2	
Desktop Screen Frameless Pinnable 16" High Supplied with Fixing Brackets 	CHPSF1648P	CHPSF1654P	CHPSF1660P	CHPSF1666P	CHPSF1672P	CHPSF1678P	Grade A
	564	609	641	667	700	726	Grade B
	602	650	685	717	755	784	Grade C
	697	752	803	839	891	928	
	SEE NOTE 2	SEE NOTE 2	SEE NOTE 2	SEE NOTE 2	SEE NOTE 2	SEE NOTE 2	

Note 1: Supplied with linking. Height from floor level to top of screen is 45". MUST BE ORDERED WITH CHFBKT SCREEN BRACKETS. All prices listed in USD \$
Ships KD = Knock Down (Assembly Required)

Note 2: Specify black, white, or silver metalwork.

PRODUCT PRICING

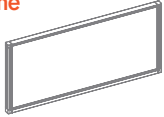
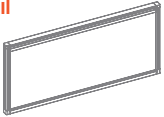
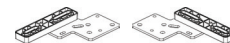
SCREENS – Desk Dividers / Screen Fixing Bracket

	Width (inch)		Code
	24"	30"	
Desk Divider with Standard Frame 16" High 	USDD1624	USDD1630	TFL
	404	428	Acrylic
	533	582	Grade A
	459	485	Grade B
	484	511	Grade C
547	575		
SEE NOTE 1	SEE NOTE 1		
Desk Divider with Single Tool Rail 16" High 	USDDT1624	USDDT1630	TFL
	418	443	Acrylic
	547	596	Grade A
	472	497	Grade B
	496	523	Grade C
561	587		
SEE NOTE 1	SEE NOTE 1		
Screen Fixing Bracket Pack Comprising of two brackets 	These brackets can only be used on single and inline Chemistry desks. Click to see detailed drawing of how to use. Brackets ordered as a pair and attach to underside of desk top.		CHFBKT1 100
			SEE NOTES 2 & 4
Screen Fixing Bracket Pack Comprising of two brackets 	These brackets can only be used on Chemistry back to back desks. Click to see component detailed drawing of how to use. Brackets ordered as a pair and attach to end and mid legs.		CHFBKT2 100
			SEE NOTES 3 & 4
120° 3 Way Linking Post 16" High 	For use only on 120 degree desks where 3 Desktop Screens have been specified		US3WPST16 92
			SEE NOTE 4

Note 1: Supplied with linking. Height from floor level to top of screen is 45". MUST BE ORDERED WITH CHFBKT SCREEN BRACKETS. All prices listed in USD \$
Ships KD = Knock Down (Assembly Required)

Note 2: To be used on single and in-line desks

Note 3: To be used on back to back desks.

Note 4: Specify black, white, or silver metalwork.

Finishes & Features Available...



TFL (1")	HD Highland Oak UM Urban Maple WH White WK Winter Oak SO Strata Oak CW Carini Walnut DN Denim LG Light Gray
Fabrics	Grade A Camira Era Grade B Camira Lucia, Camira Nexus Grade C Camira Blazer, Camira Blazer Lite, Camira Aquarius, Camira Main Line Flax, Camira Synergy, Camira Synergy 66
Acrylic Colors	Clear Opaque Crystal Opaque White Opaque Green Opaque Blue
Frame Colors	Silver White Black

To specify your desk...

1. Think through the configuration of Desk you require
2. Select the Codes of the individual items you need to achieve your configuration
3. Choose Finishes where appropriate: 'top' finishes / frame color / fabric color / acrylic color
4. Consider supporting product, screens, cable management and accessories

PRODUCT PRICING

SCREENS – Desk End Screens

	Width (inch)							Code
	24" W	30" W	54" W	60" W	66" W	72" W	78" W	
Desk End Screen with Standard Frame 45" High 	USDE4524	USDE4530	USDE4554	USDE4560	USDE4566	USDE4572	USDE4578	Code TFL Grade A Grade B Grade C
	715	748	857	897	930	962	1,000	
	811	863	1,046	1,096	1,164	1,209	1,342	
	876	939	1,227	1,230	1,317	1,373	1,519	
	1,054	1,131	1,494	1,571	1,701	1,776	1,967	
SEE NOTES 1 & 2	SEE NOTES 1 & 2	SEE NOTES 1 & 2	SEE NOTES 1 & 2	SEE NOTES 1 & 2	SEE NOTES 1 & 2	SEE NOTES 1 & 2	SEE NOTES 1 & 2	
Desk End Screen with Single Tool Rail 45" High 	USDET4524	USDET4530	USDET4554	USDET4560	USDET4566	USDET4572	USDET4578	Code TFL Grade A Grade B Grade C
	726	760	870	911	945	977	1,014	
	824	877	1,057	1,108	1,178	1,224	1,356	
	888	952	1,187	1,243	1,332	1,386	1,533	
	1,066	1,144	1,508	1,585	1,715	1,791	1,981	
SEE NOTES 1 & 2	SEE NOTES 1 & 2	SEE NOTES 1 & 2	SEE NOTES 1 & 2	SEE NOTES 1 & 2	SEE NOTES 1 & 2	SEE NOTES 1 & 2	SEE NOTES 1 & 2	
4 Way Linking Post With Adjustable Foot 45" High 	US4WPST45							Code Price
	154							

Note 1: Supplied with linking and desk end attachment bracket

Note 2: This is a desk end floor standing screen and can only be used at the end of a desk.

All prices listed in USD \$



Ships KD = Knock Down (Assembly Required)

Finishes & Features Available...

TFL (1")	HD Highland Oak UM Urban Maple WH White WK Winter Oak SO Strata Oak CW Carini Walnut DN Denim LG Light Gray
Fabrics	Grade A Camira Era Grade B Camira Lucia, Camira Nexus Grade C Camira Blazer, Camira Blazer Lite, Camira Aquarius, Camira Main Line Flax, Camira Synergy, Camira Synergy 66
Acrylic Colors	Clear Opaque Crystal Opaque White Opaque Green Opaque Blue
Frame Colors	Silver White Black

PRODUCT PRICING

SCREENS – Desk End Screens

	Width (inch)							Code
	24" W	30" W	54" W	60" W	66" W	72" W	78" W	
Partial Acrylic Desk End Screen with Standard Frame 45" High 	USDEPG4524	USDEPG4530	USDEPG4554	USDEPG4560	USDEPG4566	USDEPG4572	USDEPG4578	Code TFL Grade A Grade B Grade C
	892	941	1,069	1,113	1,181	1,248	1,315	
	939	1,005	1,183	1,243	1,319	1,395	1,470	
	998	1,057	1,269	1,341	1,424	1,503	1,585	
	1,099	1,186	1,482	1,581	1,678	1,774	1,868	
SEE NOTES 1 & 2	SEE NOTES 1 & 2	SEE NOTES 1 & 2	SEE NOTES 1 & 2	SEE NOTES 1 & 2	SEE NOTES 1 & 2	SEE NOTES 1 & 2	SEE NOTES 1 & 2	
Partial Acrylic Desk End Screen with Single Tool Rail 45" High 	USDEPGT4524	USDEPGT4530	USDEPGT4554	USDEPGT4560	USDEPGT4566	USDEPGT4572	USDEPGT4578	Code TFL Grade A Grade B Grade C
	907	953	1,081	1,124	1,192	1,260	1,328	
	952	1,019	1,195	1,256	1,331	1,408	1,483	
	1,103	1,071	1,281	1,352	1,435	1,516	1,598	
	1,114	1,199	1,494	1,593	1,690	1,785	1,881	
SEE NOTES 1 & 2	SEE NOTES 1 & 2	SEE NOTES 1 & 2	SEE NOTES 1 & 2	SEE NOTES 1 & 2	SEE NOTES 1 & 2	SEE NOTES 1 & 2	SEE NOTES 1 & 2	
4 Way Linking Post With Adjustable Foot 45" High 	US4WPST45							Code Price
	154							

Note 1: Supplied with linking and desk end attachment bracket

Note 2: This is a desk end floor standing screen and can only be used at the end of a desk.

All prices listed in USD \$



Ships KD = Knock Down (Assembly Required)

To specify your desk...

1. Think through the configuration of Desk you require
2. Select the Codes of the individual items you need to achieve your configuration
3. Choose Finishes where appropriate: 'top' finishes / frame color / fabric color / acrylic color
4. Consider supporting product, screens, cable management and accessories

PRODUCT PRICING

SCREENS – Desk End Screens

	Width (inch)							Code
	24" W	30" W	54" W	60" W	66" W	72" W	78" W	
Desk End Screen with Standard Frame 55" High 	USDE5524	USDE5530	USDE5554	USDE5560	USDE5566	USDE5572	USDE5578	Code TFL Grade A Grade B Grade C
	795	846	992	1,044	1,087	1,124	1,174	
	887	943	1,157	1,214	1,291	1,342	1,483	
	956	1,020	1,285	1,349	1,445	1,504	1,662	
	1,125	1,212	1,605	1,691	1,827	1,909	2,110	
SEE NOTES 1 & 2	SEE NOTES 1 & 2	SEE NOTES 1 & 2	SEE NOTES 1 & 2	SEE NOTES 1 & 2	SEE NOTES 1 & 2	SEE NOTES 1 & 2	SEE NOTES 1 & 2	
Desk End Screen with Single Tool Rail 55" High 	USDET5524	USDET5530	USDET5554	USDET5560	USDET5566	USDET5572	USDET5578	Code TFL Grade A Grade B Grade C
	810	860	1,004	1,055	1,099	1,139	1,188	
	901	957	1,171	1,226	1,303	1,357	1,497	
	970	1,034	1,298	1,361	1,457	1,519	1,676	
	1,140	1,226	1,619	1,704	1,840	1,923	2,124	
SEE NOTES 1 & 2	SEE NOTES 1 & 2	SEE NOTES 1 & 2	SEE NOTES 1 & 2	SEE NOTES 1 & 2	SEE NOTES 1 & 2	SEE NOTES 1 & 2	SEE NOTES 1 & 2	
4 Way Linking Post With Adjustable Foot 55" High 	US4WPST55							Code Price
	182							

Note 1: Supplied with linking and desk end attachment bracket

Note 2: This is a desk end floor standing screen and can only be used at the end of a desk.

All prices listed in USD \$



Ships KD = Knock Down (Assembly Required)

Finishes & Features Available...

TFL (1")	HD Highland Oak UM Urban Maple WH White WK Winter Oak SO Strata Oak CW Carini Walnut DN Denim LG Light Gray
Fabrics	Grade A Camira Era Grade B Camira Lucia, Camira Nexus Grade C Camira Blazer, Camira Blazer Lite, Camira Aquarius, Camira Main Line Flax, Camira Synergy, Camira Synergy 66
Acrylic Colors	Clear Opaque Crystal Opaque White Opaque Green Opaque Blue
Frame Colors	Silver White Black

PRODUCT PRICING

SCREENS – Desk End Screens

	Width (inch)							Code
	24" W	30" W	54" W	60" W	66" W	72" W	78" W	
Partial Acrylic Desk End Screen with Standard Frame 55" High 	USDEPG5524	USDEPG5530	USDEPG5554	USDEPG5560	USDEPG5566	USDEPG5572	USDEPG5578	Code TFL Grade A Grade B Grade C
	1,125	1,140	1,352	1,366	1,537	1,706	1,877	
	1,172	1,203	1,469	1,499	1,695	1,853	2,033	
	1,212	1,252	1,554	1,594	1,777	1,962	2,146	
	1,265	1,381	1,723	1,836	2,034	2,231	2,431	
SEE NOTES 1 & 2	SEE NOTES 1 & 2	SEE NOTES 1 & 2	SEE NOTES 1 & 2	SEE NOTES 1 & 2	SEE NOTES 1 & 2	SEE NOTES 1 & 2	SEE NOTES 1 & 2	
Partial Acrylic Desk End Screen with Single Tool Rail 55" High 	USDEPGT5524	USDEPGT5530	USDEPGT5554	USDEPGT5560	USDEPGT5566	USDEPGT5572	USDEPGT5578	Code TFL Grade A Grade B Grade C
	1,140	1,154	1,366	1,379	1,551	1,720	1,898	
	1,187	1,216	1,483	1,512	1,689	1,868	2,044	
	1,227	1,265	1,568	1,607	1,791	1,976	2,159	
	1,280	1,394	1,737	1,849	2,048	2,245	2,442	
SEE NOTES 1 & 2	SEE NOTES 1 & 2	SEE NOTES 1 & 2	SEE NOTES 1 & 2	SEE NOTES 1 & 2	SEE NOTES 1 & 2	SEE NOTES 1 & 2	SEE NOTES 1 & 2	
4 Way Linking Post With Adjustable Foot 55" High 	US4WPST55							Code Price
	182							

Note 1: Supplied with linking and desk end attachment bracket

Note 2: This is a desk end floor standing screen and can only be used at the end of a desk.



All prices listed in USD \$

Ships KD = Knock Down (Assembly Required)

To specify your desk...

1. Think through the configuration of Desk you require
2. Select the Codes of the individual items you need to achieve your configuration
3. Choose Finishes where appropriate: 'top' finishes / frame color / fabric color / acrylic color
4. Consider supporting product, screens, cable management and accessories

SCREENS – Desk End Screens

	Width (inch)							Code
	24" W	30" W	54" W	60" W	66" W	72" W	78" W	
Desk End Screen with Standard Frame 62" High 	USDE6224	USDE6230	USDE6254	USDE6260	USDE6266	USDE6272	USDE6278	Code TFL Grade A Grade B Grade C
	837	890	1,043	1,095	1,141	1,182	1,233	
	880	943	1,285	1,348	1,437	1,502	1,654	
	1,099	1,137	1,455	1,529	1,640	1,716	1,892	
	1,89	1,392	1,881	1,984	2,154	2,257	2,488	
SEE NOTES 1 & 2	SEE NOTES 1 & 2	SEE NOTES 1 & 2	SEE NOTES 1 & 2	SEE NOTES 1 & 2	SEE NOTES 1 & 2	SEE NOTES 1 & 2		
Desk End Screen with Single Tool Rail 62" High 	USDET6224	USDET6230	USDET6254	USDET6260	USDET6266	USDET6272	USDET6278	Code TFL Grade A Grade B Grade C
	849	904	1,054	1,108	1,155	1,193	1,247	
	893	957	1,297	1,361	1,451	1,514	1,669	
	1,074	1,151	1,468	1,542	1,654	1,729	1,906	
	1,303	1,406	1,893	1,997	2,166	2,268	2,503	
SEE NOTES 1 & 2	SEE NOTES 1 & 2	SEE NOTES 1 & 2	SEE NOTES 1 & 2	SEE NOTES 1 & 2	SEE NOTES 1 & 2	SEE NOTES 1 & 2		
4 Way Linking Post With Adjustable Foot 62" High 	US4WPST62							Code Price
194								

Note 1: Supplied with linking and desk end attachment bracket

Note 2: This is a desk end floor standing screen and can only be used at the end of a desk.



All prices listed in USD \$

Ships KD = Knock Down (Assembly Required)

Finishes & Features Available...

TFL (1")	HD Highland Oak UM Urban Maple WH White WK Winter Oak SO Strata Oak CW Carini Walnut DN Denim LG Light Gray
Fabrics	Grade A Camira Era Grade B Camira Lucia, Camira Nexus Grade C Camira Blazer, Camira Blazer Lite, Camira Aquarius, Camira Main Line Flax, Camira Synergy, Camira Synergy 66
Acrylic Colors	Clear Opaque Crystal Opaque White Opaque Green Opaque Blue
Frame Colors	Silver White Black

SCREENS – Desk End Screens

	Width (inch)							Code
	24" W	30" W	54" W	60" W	66" W	72" W	78" W	
Partial Acrylic Desk End Screen with Standard Frame 62" High 	USDEPG6224	USDEPG6230	USDEPG6254	USDEPG6260	USDEPG6266	USDEPG6272	USDEPG6278	Code TFL Grade A Grade B Grade C
	1,187	1,226	1,487	1,516	1,694	1,890	2,050	
	1,254	1,289	1,603	1,647	1,832	2,019	2,205	
	1,308	1,338	1,688	1,743	1,935	2,127	2,318	
	1,428	1,467	1,901	1,985	2,191	2,396	2,603	
SEE NOTES 1 & 2	SEE NOTES 1 & 2	SEE NOTES 1 & 2	SEE NOTES 1 & 2	SEE NOTES 1 & 2	SEE NOTES 1 & 2	SEE NOTES 1 & 2		
Partial Acrylic Desk End Screen with Single Tool Rail 62" High 	USDEPGT6224	USDEPGT6230	USDEPGT6254	USDEPGT6260	USDEPGT6266	USDEPGT6272	USDEPGT6278	Code TFL Grade A Grade B Grade C
	1,119	1,240	1,501	1,529	1,707	1,884	2,062	
	1,265	1,302	1,617	1,637	1,845	2,033	2,217	
	1,320	1,351	1,702	1,757	1,948	2,140	2,332	
	1,441	1,480	1,915	1,999	2,204	2,408	2,616	
SEE NOTES 1 & 2	SEE NOTES 1 & 2	SEE NOTES 1 & 2	SEE NOTES 1 & 2	SEE NOTES 1 & 2	SEE NOTES 1 & 2	SEE NOTES 1 & 2		
4 Way Linking Post With Adjustable Foot 62" High 	US4WPST62							Code Price
194								

Note 1: Supplied with linking and desk end attachment bracket

Note 2: This is a desk end floor standing screen and can only be used at the end of a desk.

All prices listed in USD \$

Ships KD = Knock Down (Assembly Required)

To specify your desk...

1. Think through the configuration of Desk you require
2. Select the Codes of the individual items you need to achieve your configuration
3. Choose Finishes where appropriate: 'top' finishes / frame color / fabric color / acrylic color
4. Consider supporting product, screens, cable management and accessories

SCREENS – Glass Screens

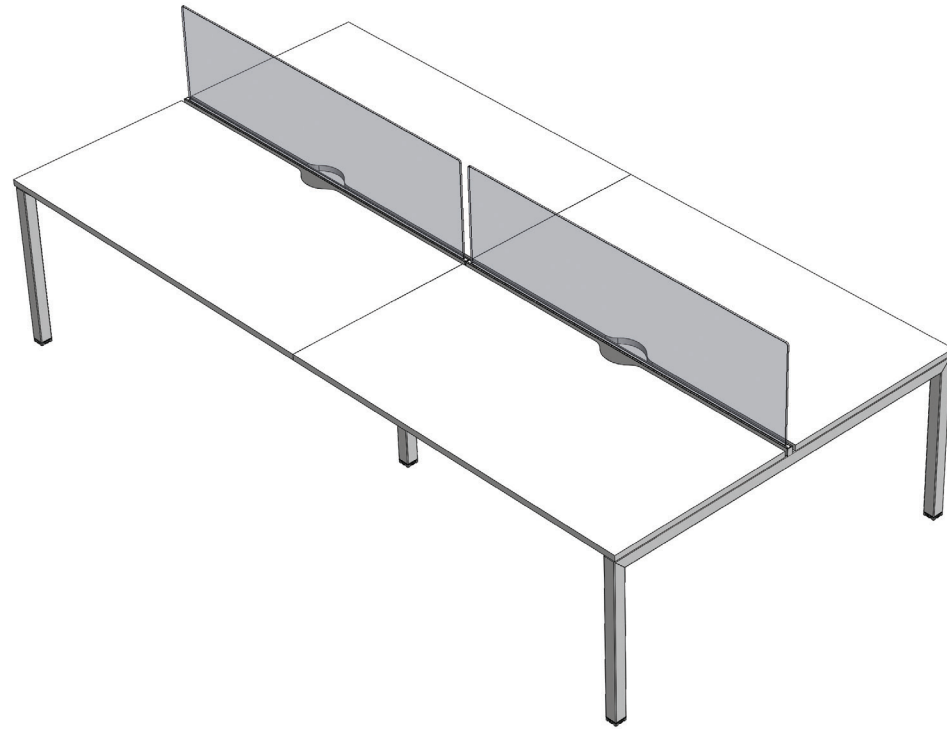

	Width (inch)						Code
	48" W	54" W	60" W	66" W	72" W	78" W	
Glass Screen 16" High	CHGS1648 277	CHGS1654 307	CHGS1660 336	CHGS1666 365	CHGS1672 391	CHGS1678 420	Price
Glass Screen Rails End to End	CHGSR48 423	CHGSR54 446	CHGSR60 467	CHGSR66 489	CHGSR72 510	CHGSR78 530	Price
Glass Screen Rails End to Mid	CHGSRE48 423	CHGSRE54 446	CHGSRE60 467	CHGSRE66 489	CHGSRE72 510	CHGSRE78 530	Price
Glass Screen Rails Mid to Mid	CHGSRM48 423	CHGSRM54 446	CHGSRM60 467	CHGSRM66 489	CHGSRM72 510	CHGSRM78 530	Price

All prices listed in USD \$
Ships KD = Knock Down (Assembly Required)

Finishes & Features Available...

Glass Colors	Clear Gray Smoked
Rail Colors	Silver White Black

SCREENS – Divider Screens

TFL Fixed Desk Divider Screen



Acrylic Fixed Desk Divider Screen



TFL Freestanding Desk Divider Screen



Acrylic Freestanding Desk Divider Screen



	Width (inch)			Code
	30" W	36" W	48" W	
CVXDDS30 243 SEE NOTE 1	-	-	-	Price
CVXDDSA30 638 SEE NOTE 1	-	-	-	Price
CVXDDFS30 240 SEE NOTE 1	CVXDDFS36 249 SEE NOTE 1	CVXDDFS48 259 SEE NOTE 1		Price
CVXDDFSA30 605 SEE NOTE 1	CVXDDFSA36 585 SEE NOTE 1	CVXDDFSA48 783 SEE NOTE 1		Price

Note 1: Please specify if brackets are Silver, White, or Black.

All prices listed in USD \$
Ships KD = Knock Down (Assembly Required)



To specify your desk...

1. Think through the configuration of Desk you require
2. Select the Codes of the individual items you need to achieve your configuration
3. Choose Finishes where appropriate: 'top' finishes / frame color / fabric color / acrylic color
4. Consider supporting product, screens, cable management and accessories

CHEMISTRY ACCESSORIES

Clear and organized spaces are known for enhancing efficiency in the office, Senator's range of desk accessories provide a place for everything to maximize productivity at the workstation. Seamlessly integrating with the Chemistry range, the variety of accessories available from pen pots and whiteboards to tablet holders are designed to support the diverse needs of different working styles, by allowing users to personalize their own workspaces.

CHEMISTRY ACCESSORIES

Pen Pot With Rail Holder 	DAPPH 72 SEE NOTE 1	Code Price
Pen Tray 	DAPT 61 SEE NOTE 1	Code Price
Tablet Holder 	DATH 55 SEE NOTE 1	Code Price
Paper Tray Hanger 	DAPTHA4 95 SEE NOTE 1	Code Price
Paper Tray 	DAPTA4 67 SEE NOTE 1	Code Price
Hanger for Magnetic White Board 	DAWBH 47 SEE NOTE 1	Code Price
Magnetic White Board 8.25in x 11.75in 	DAWBA4 164 SEE NOTE 1	Code Price
Magnetic White Board 11.75in x 16.5in 	DAWBA3 206 SEE NOTE 1	Code Price

Note 1: Only available in White.

All prices listed in USD \$

DESK ACCESSORIES

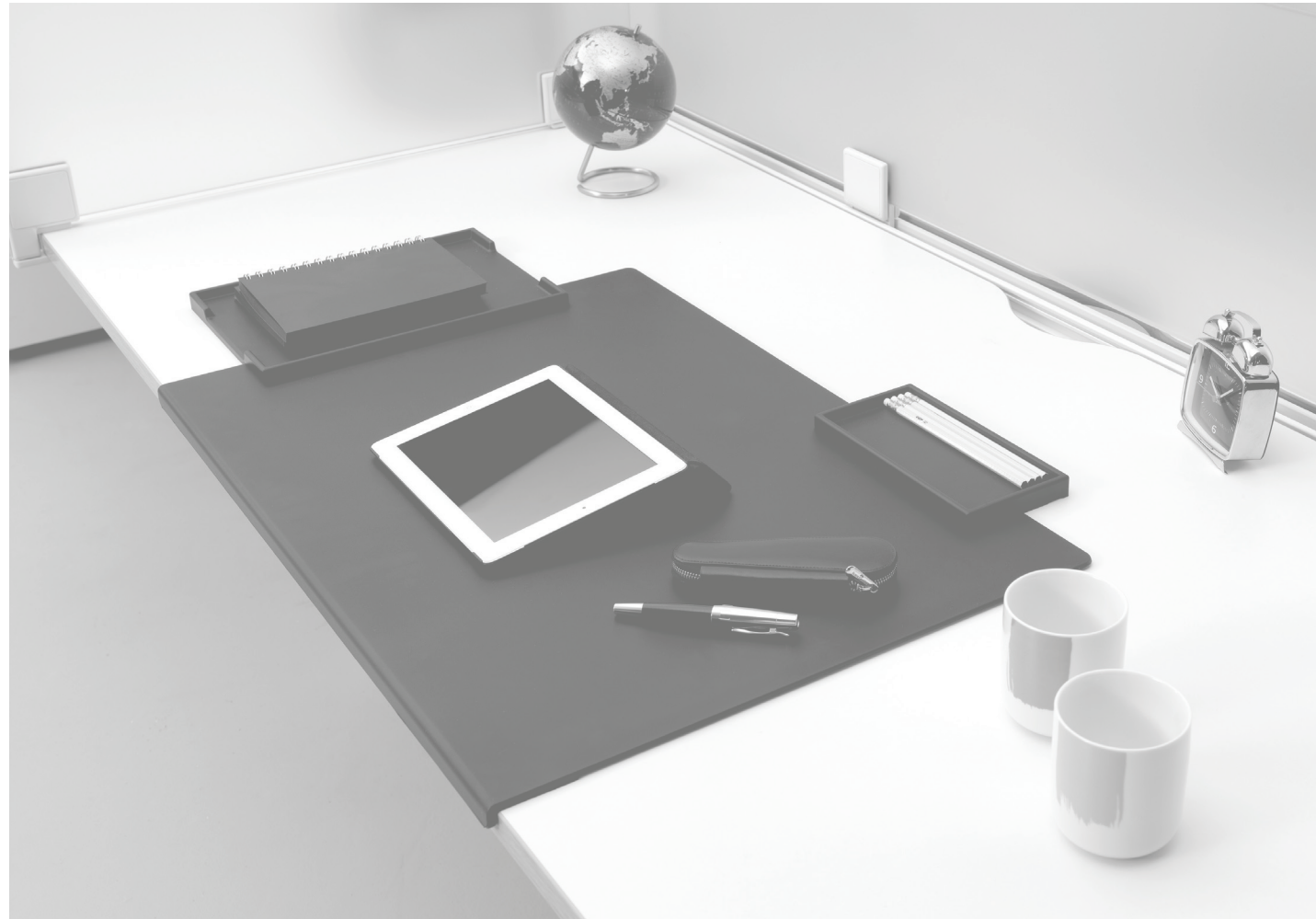

Organizing Desk Pad
30" x 20.5"

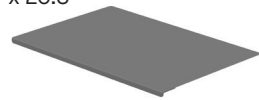

**Organizing Desk Pad
Accessory Set**
Paper tray/pen
tray/cup holder



DAM01	Code
262	Price
SEE NOTE 1	
DAMACC	Code
342	Price
SEE NOTE 1	

Note 1: Only available in Black.

All prices listed in USD \$

DESK ACCESSORIES



**White Board Desk
Divider Clip**



**Magnetic
White Board**
8.25in x
11.75in



**Magnetic
White Board**
11.75in x
16.5in



**Single Binder
Holder with
Pen Pot**



**Binder
Holder**



DAWBDC	Code
30	Price
SEE NOTE 1	
DAWBA4	Code
164	Price
SEE NOTE 1	
DAWBA3	Code
206	Price
SEE NOTE 1	
DABHPP	Code
98	Price
SEE NOTE 1	
DABH	Code
138	Price
SEE NOTE 1	

Note 1: Only available in White.

All prices listed in USD \$

CHEMISTRY DESK ACCESSORIES

M2 Desk Mounted Adjustable Monitor Arm

Please specify DC if desk clamped or CP for cableport fixed. Suitable for 1" tops.



M2CLF17DC 638 SEE NOTE 1	M2CLF17CP 638 SEE NOTE 1	Code
		Price
ADPSC 423 SEE NOTE 2		Code
		Price
ADPSS 434		Code
		Price

Above Desk Power (3-Prong Plug)

- Above table
- White or Black
- Two power outlets
- 1 powered USB-A
- 1 powered USB-C
- 10 ft power cord with 3-prong plug



Above Desk Power (Hardwire)

- Above table
- White or Black
- Two power outlets
- 1 powered USB-A
- 1 powered USB-C
- 10 ft hardwire infeed



Note 1: All monitor arms are compatible with most flat screen monitors. Please ensure monitors have VESA mounting. Consult with the Sales Office for more details.

Note 2: Available in White or Black. Please specify when ordering.

All prices listed in USD \$

CHEMISTRY POWER

84 System Hardwire Infeeds. 8 wire 4 Circuit

For Single, Inline, and Bench desk power block options



Single Desk Electrical Kit

- 1 x power block
- 4 x receptacles
- 1 x jumper cable

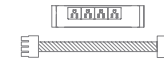

Single Desk End of Run Block

- 1 x power block
- 4 x receptacles



Bench Desk Electrical Kit

- 1 x power block
- 8 x receptacles
- 1 x jumper cable

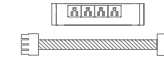

Bench Desk End of Run Block

- 1 x power block
- 8 x receptacles



Length (inches)		
72"	108"	144"
72HWINF84 231	108HWINF84 296	144HWINF84 363
		Code
		Price

Single/Inline Desk Power Blocks					
Length (inches)					
48"	54"	60"	66"	72"	78"
EK48SB 8W4C 372 SEE NOTE 1	EK54SB 8W4C 382	EK60SB 8W4C 393	EK66SB 8W4C 405	EK72SB 8W4C 416	EK78SB 8W4C 426
					Code
					Price

EKEORSSB 197					
					Code
					Price

Bench Desk Power Blocks					
Length (inches)					
48"	54"	60"	66"	72"	78"
EK48DSB 8W4C 467 SEE NOTE 2	EK54DSB 8W4C 479	EK60DSB 8W4C 490	EK66DSB 8W4C 499	EK72DSB 8W4C 512	EK78DSB 8W4C 522
					Code
					Price

EKEORDSB 279					
					Code
					Price

Note 1: If ordering 120 degree single desks, you must specify a 48" single desk electrical kit.

Note 2: If ordering 120 degree back to back bench desks, you must specify bench desk electrical kit.

All prices listed in USD \$

FINISHES

CHEMISTRY FINISHES – Standard Top Finishes – TFL



Carini Walnut



Strata Oak



Urban Maple



Highland Oak



Winter Oak

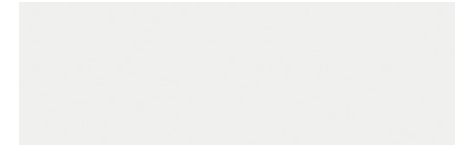

White



Light Gray



Denim

Color images above are for reference only. Please verify with actual color sample.

CHEMISTRY FINISHES

CONTRASTING EDGE BAND



Ply Effect Edging

All TFL (Edge 69) tops come with a matching edge band as standard. Contrasting edge band can be specified.

Please contact customer service if you require a contrasting edge band.



FRAME / LEG FINISHES

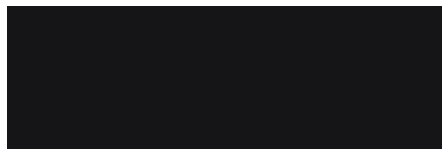

Black

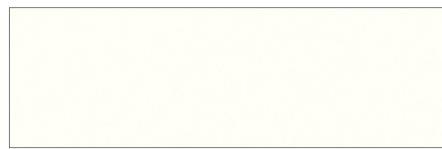

White

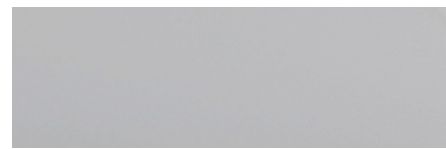

Silver

STANDARD PANEL FINISHES – Acrylic



Clear

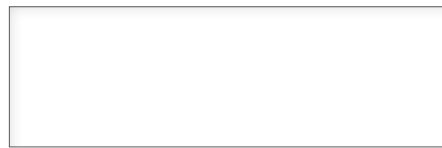

Opaque Crystal

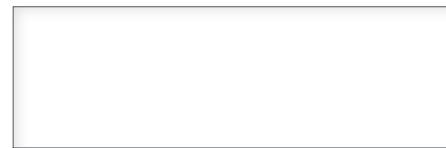

Opaque White



Opaque Green



Opaque Blue

GLASS SCREEN FINISHES



Clear



Gray Smoked

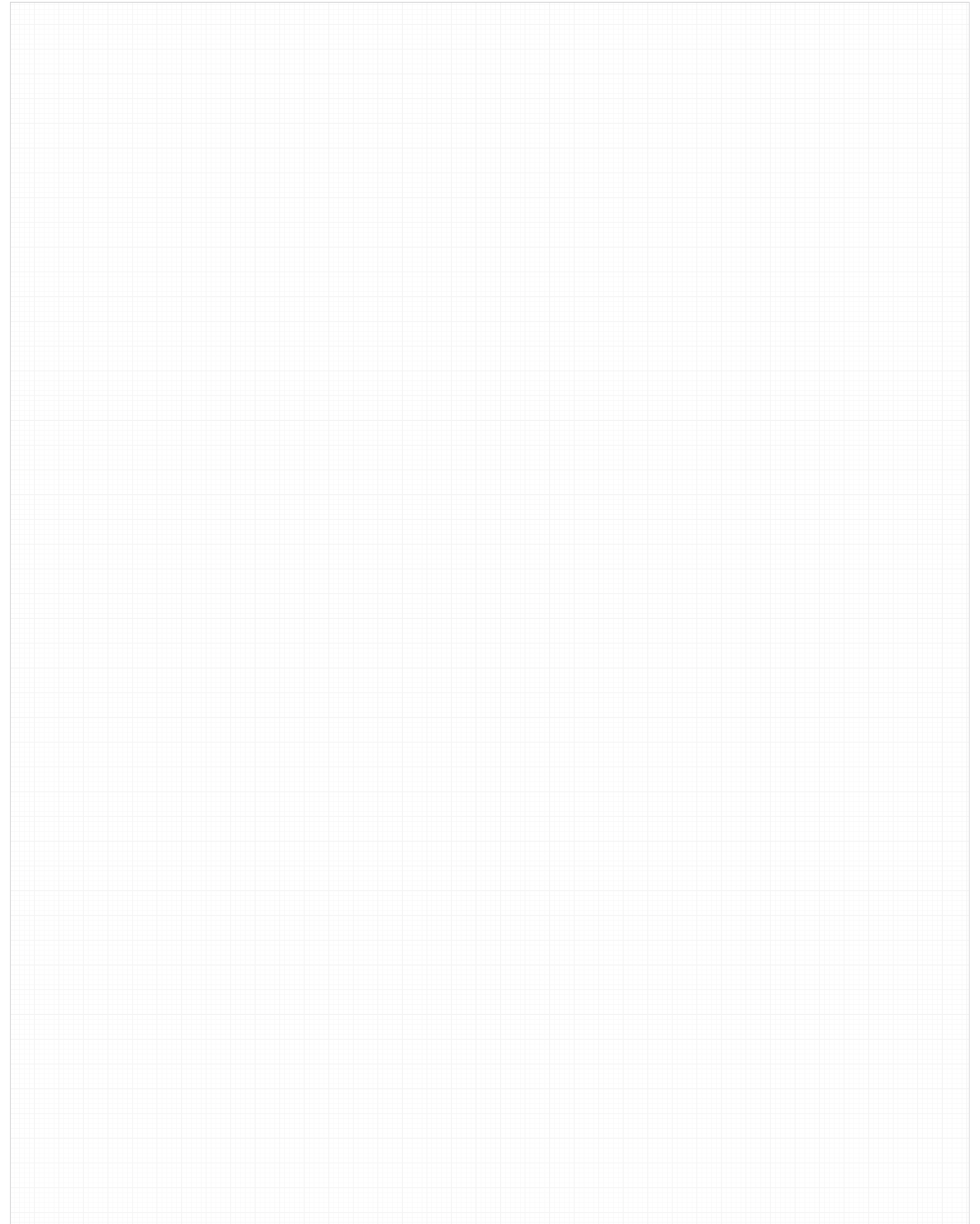

CHEMISTRY MEETING TABLES

STANDARD FEATURES (*Selected models only)

- 2" square Steel tube legs with mitred corners
- 1/4" shadow gap between top and frame
- Universally sized Steel dual crossrails
- Leveling feet
- 1" TFL rectangular tops

SPECIFIABLE FEATURES

- In-desk power modules*

OPTIONAL FEATURES

- Desk extensions*
- Storage boxes*
- Cable trays and risers*

PERFORMANCE STANDARDS

- Designed to conform to and where applicable is tested to the following standards:
- BIFMA X5.5 x2014
 - SCS-EC10.3-2014 v. 3.0 Indoor Advantage Gold

CHEMISTRY MEETING TABLES

Chemistry meeting tables share the same frame as Chemistry workstations for consistent design aesthetics. Designed as a response to the demand for workspaces that are flexible and collaborative, Chemistry meeting tables are efficient and streamlined, creating an atmosphere that can be both formal and informal.

DIMENSIONS

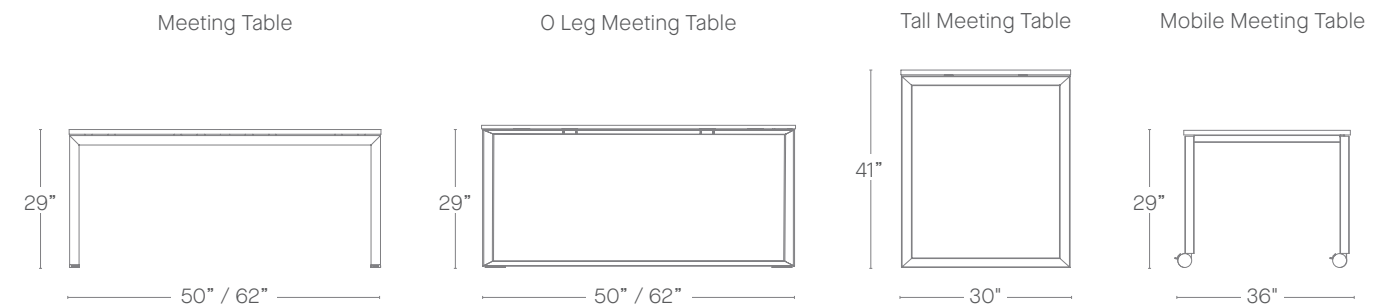

Meeting Table
Widths. 50"-78"
Depths. 50" or 62"

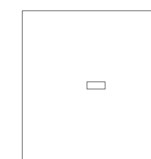

Meeting Table with Power
Widths. 50"-78"
Depths. 50" or 62"

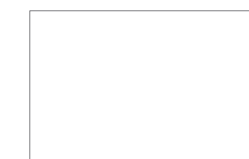

Tall Meeting Table
Widths. 62"-78"
Depths. 30"



Mobile Meeting Table
Widths. 36"
Depths. 36"

CHEMISTRY MEETING TABLES

● Available
□ Not available

Meeting Table

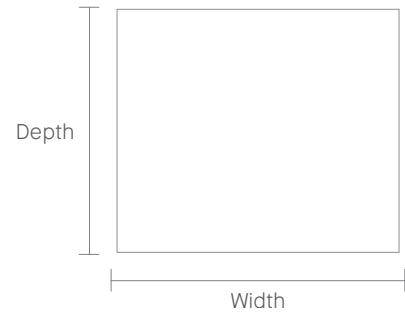

50" / 62" Deep Table



	50" W	60" W	66" W	72" W	78" W
50" D	●	●	●	●	●
62" D	●	●	●	●	●

Meeting Table with Power

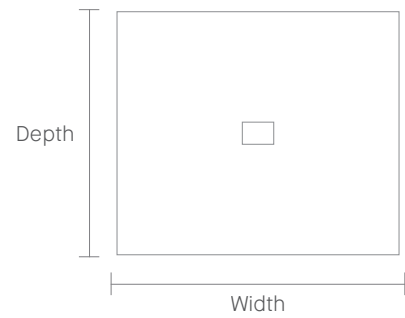

50" / 62" Deep Table with Power



	50" W	60" W	66" W	72" W	78" W
50" D	●	●	●	●	●
62" D	●	●	●	●	●

CHEMISTRY MEETING TABLES

● Available
□ Not available

Extensions and Storage Boxes



Extension



16" high storage box



16" D	50" W	62" W
	●	●

Power Modules

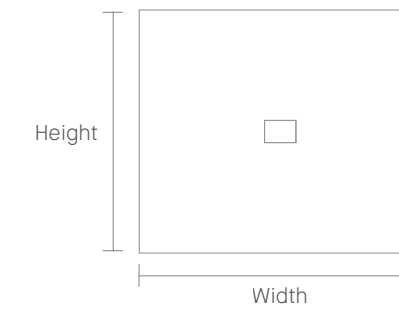

OAS815X / OAS815DCX

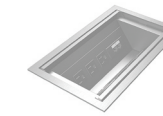

COV15Y / COV15DCY



	Power Outlets	USB Charging	Data
OAS815X / OAS815DCX	●	-	●
COV15Y / COV15DCY	●	●	-

Cable Trays



Double Cable Tray

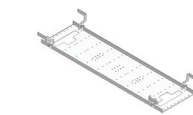

50" W	60" W	66" W	72" W	78" W
●	●	●	●	●

Cable Risers

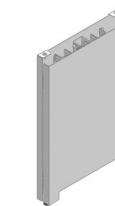

Double Cable Riser

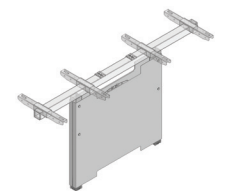

Mid Leg Cable riser

CHEMISTRY MEETING TABLES

● Available
□ Not available

Tall Meeting Table



	60" W	66" W	72" W	78" W
30" D	●	●	●	●

Mobile Meeting Table

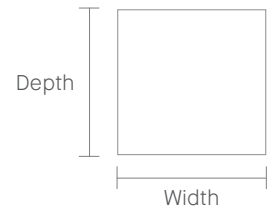

	36" W
36" D	●

CHEMISTRY ANCILLARY TABLES

● Available
□ Not available

AV Media Table



42" D	29" H	41" H
49" W	●	●

Tech Table



48" D	130" W	165" W
41" H	●	●

Not supplied with monitor arm and display

Accessories



M2 Monitor Arm



In Desk Power
(1 Power, 2 USB
Charging)

CHEMISTRY MEETING TABLES – Goal Post Leg

50" / 62" MEETING TABLE

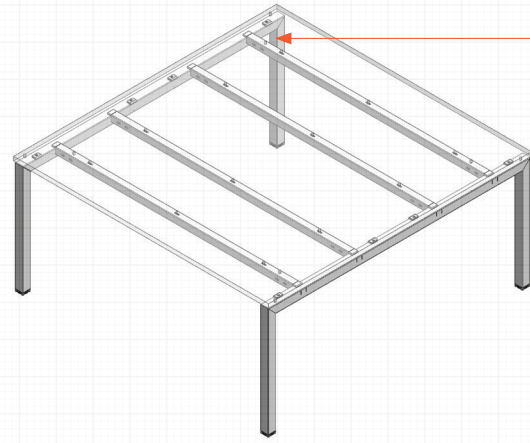

50" or 62" Meeting Table
Large meeting tables comprise of (2) end legs, (4) beams and (1) work surface.

50" / 62" MEETING TABLE WITH POWER

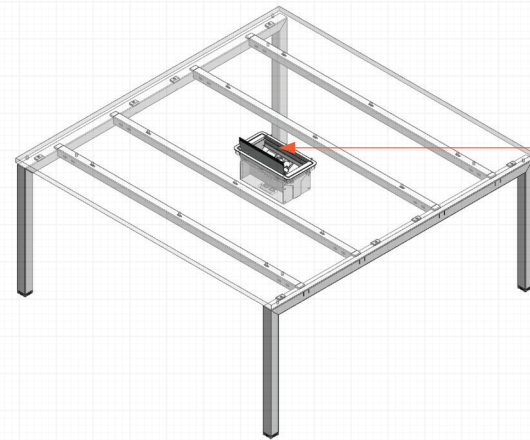

50" or 62" Meeting Table with Power
Large meeting tables comprise of (2) end legs, (4) beams and (1) work surface.
Optional In desk power modules can be ordered with (4) power and (3) data, or (2) power and (2) USB charging.
Optional In desk power modules can be ordered with a 108" power cord with 3 prong plug, or daisy chained together with a hardwire infeed and jumper cable.

50" / 62" MEETING TABLE WITH MID LEG

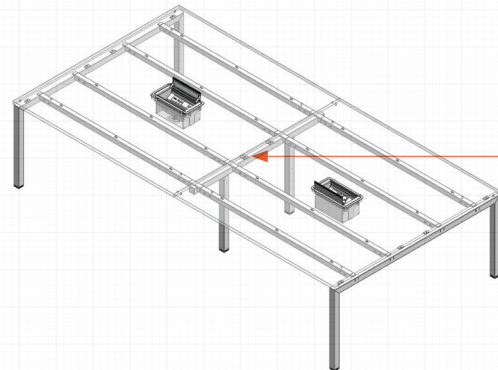

Mid Leg Meeting Table
Similar to Chemistry desking, meeting tables can be connected using a mid leg. You can link as many tables as necessary to complete your configuration.

WORK SURFACES

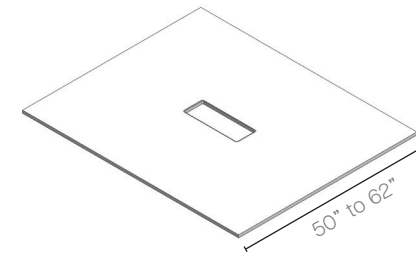

Chemistry meeting table tops are available in 50", and 62" depths and lengths of 50", 60", 66", 72", and 78".
Tops are available in TFL and can be cut to take optional power units.
TFL tops have a 2mm edge band all around.

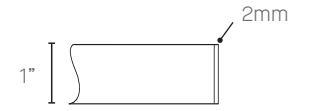

FRAMEWORK



End Legs
End legs are 50" or 62" wide.
Each end leg has spigots protruding from the frame to allow the beams to be bolted into place. Adjustable feet come standard.



Mid Legs
Mid legs are used to connect starter desks and add on desks. They have double sided spigots to attach beams to both sides and come with adjustable feet as standard.



Beams
Beams are Steel box tubes used to connect the legs together. They bolt at each end to the spigots and also through to the top.
Beams come in lengths of 50", 60", 66", 72", and 78".

FRAMEWORK

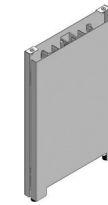

Double Cable Riser
A Double cable riser or Mid leg cable riser is available to transport power from the ground up to the underside of the optional power modules.

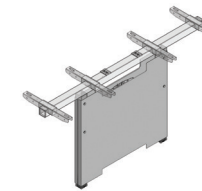

Mid Leg Cable Riser

POWER MODULES

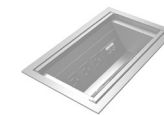

OAS815X
(4) Power, (3) Data
108" 3 Prong Plug



COV15Y
(2) Power, (2) USB Charging
108" 3 Prong Plug

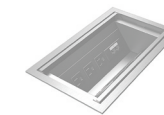

OAS815DCX
(4) Power, (3) Data
Hardwire Infeed



COV15Y
(2) Power, (2) USB Charging
Hardwire Infeed

CHEMISTRY TALL MEETING TABLES

TALL MEETING TABLES

Tall Meeting Tables are designed to facilitate flexible and diverse workspaces, allowing a change of posture during the work day

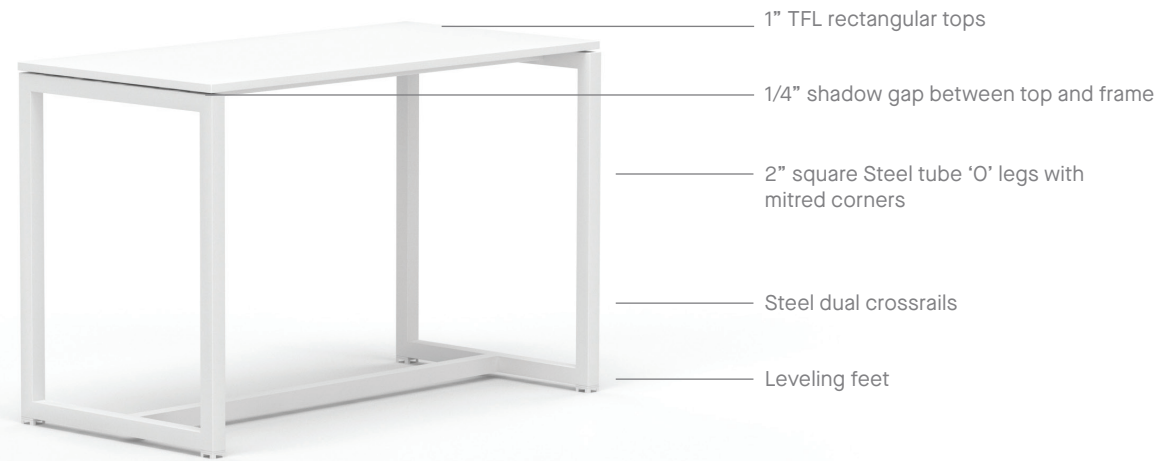

DIMENSIONS

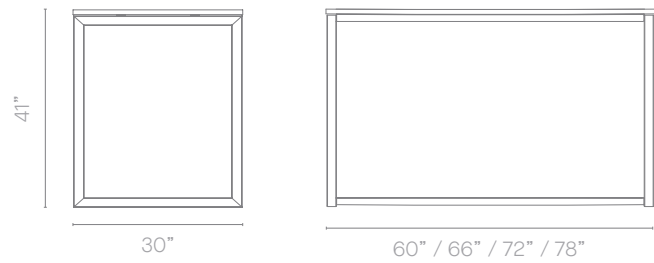

FEATURES



Plastic molded leveling feet, offering 1" of adjustment

CHEMISTRY MOBILE MEETING TABLES

MOBILE MEETING TABLES

Mobile Meeting Tables are elegantly designed and well engineered. Combining functionality and style, they are ideal for a variety of applications.

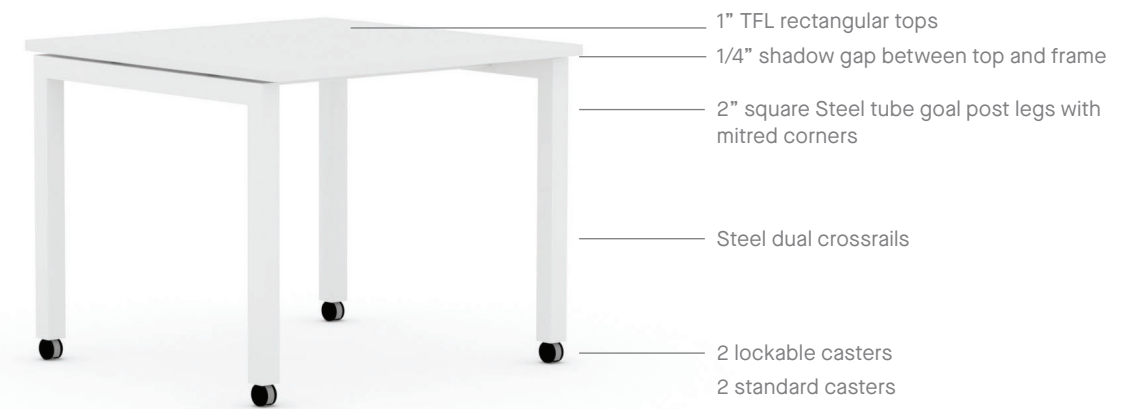

DIMENSIONS

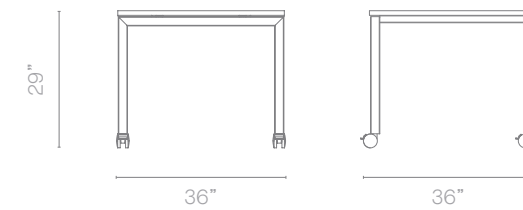

FEATURES



Lockable casters allow unit to be easily relocated and firmly held in position while in use

CHEMISTRY ANCILLARY TABLES

AV MEDIA TABLE

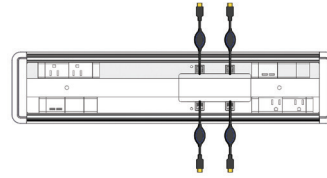
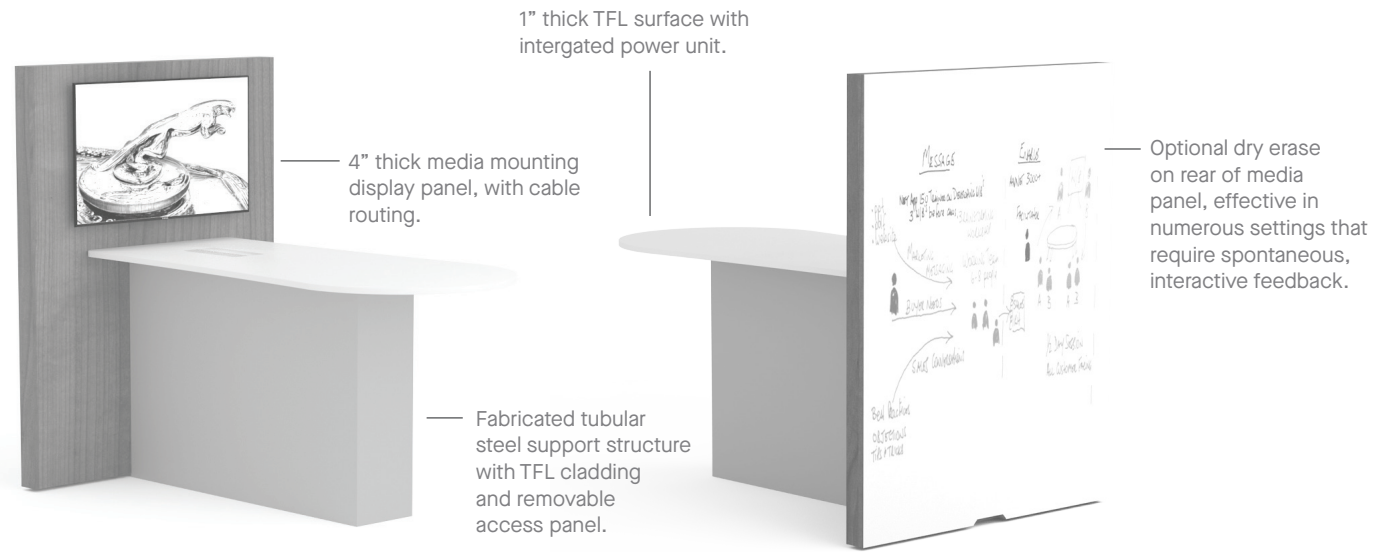

In-work surface power
Includes:
4x power
4x powered USB
4x HDMI*
ShowMe cables for transfer of laptop data to main display

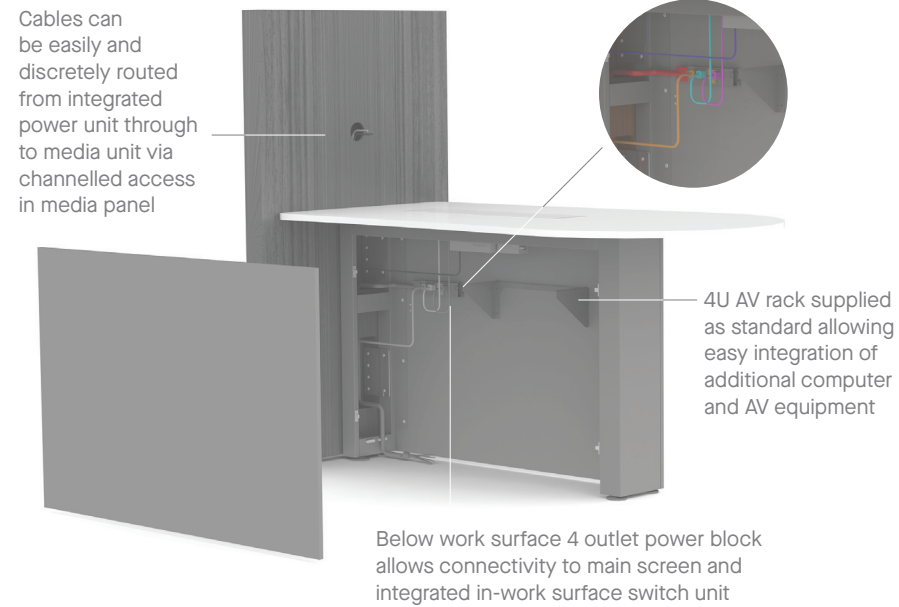

Access panel can be removed tool free via use of push fit clips

CHEMISTRY ANCILLARY TABLES

TECH TABLE



Grain Direction
Grain direction side to side on horizontal panels and top to bottom on vertical panels.

Storage Options
Lockable Tech Table perfectly designed for collaborative working. Available in:

3 compartment - 41"H x 30"D x 130"W
4 compartment - 41"H x 30"D x 165" W

Central units have no vertical divider which allows mass storage.

FEATURES



Ends of units are vented to allow computers to be stored within.







Top surface comes complete with 4 portholes for management of cables and the ability to accessorize with both monitor arms and in-desk power.



PRODUCT PRICING

CHEMISTRY MEETING TABLES – Goal Post Leg with No Power Cutout

		Width (inch)						
		36" W	50" W	60" W	66" W	72" W	78" W	
Meeting Table 50" Depth 		-	CHMT5050 1,883	CHMT6050 1,953	CHMT6650 2,094	CHMT7250 2,131	CHMT7850 2,171	Code
			SEE NOTE 1	SEE NOTE 1	SEE NOTE 1	SEE NOTE 1	SEE NOTE 1	TFL
Add On Meeting Table 50" Depth 		-	CHMT5050A 1,244	CHMT6050A 1,315	CHMT6650A 1,457	CHMT7250A 1,494	CHMT7850A 1,533	Code
			SEE NOTE 1	SEE NOTE 1	SEE NOTE 1	SEE NOTE 1	SEE NOTE 1	TFL
Meeting Table 62" Depth 		-	CHMT5062 1,975	CHMT6062 2,042	CHMT6662 2,189	CHMT7262 2,231	CHMT7862 2,276	Code
			SEE NOTE 1	SEE NOTE 1	SEE NOTE 1	SEE NOTE 1	SEE NOTE 1	TFL
Add On Meeting Table 62" Depth 		-	CHMT5062A 1,309	CHMT6062A 1,377	CHMT6622A 1,522	CHMT7262A 1,565	CHMT7862A 1,610	Code
			SEE NOTE 1	SEE NOTE 1	SEE NOTE 1	SEE NOTE 1	SEE NOTE 1	TFL
Mobile Meeting Table 36" depth x 29" high 		CHMT3636M 1,419	-	-	-	-	-	Code
								TFL

Note 1: Tables come with no power cut out. Click here to see tables with power cut outs.

All prices listed in USD \$
Ships KD = Knock Down (Assembly Required)

PRODUCT PRICING

CHEMISTRY MEETING TABLES – 'O' Leg with No Power Cutout

		Width (inch)					
		50" W	60" W	66" W	72" W	78" W	
Meeting Table 50" Depth 		CHOMT5050 2,411	CHOMT6050 2,478	CHOMT6650 2,621	CHOMT7250 2,659	CHOMT7850 2,697	Code
		SEE NOTE 1	SEE NOTE 1	SEE NOTE 1	SEE NOTE 1	SEE NOTE 1	TFL
Add On Meeting Table 50" Depth 		CHMT5050A 1,244	CHMT6050A 1,315	CHMT6650A 1,457	CHMT7250A 1,494	CHMT7850A 1,533	Code
		SEE NOTE 1	SEE NOTE 1	SEE NOTE 1	SEE NOTE 1	SEE NOTE 1	TFL
Meeting Table 62" Depth 		CHOMT5062 2,476	CHOMT6062 2,542	CHOMT6662 2,687	CHOMT7262 2,732	CHOMT7862 2,777	Code
		SEE NOTE 1	SEE NOTE 1	SEE NOTE 1	SEE NOTE 1	SEE NOTE 1	TFL
Add On Meeting Table 62" Depth 		CHMT5062A 1,309	CHMT6062A 1,377	CHMT6662A 1,522	CHMT7262A 1,565	CHMT7862A 1,610	Code
		SEE NOTE 1	SEE NOTE 1	SEE NOTE 1	SEE NOTE 1	SEE NOTE 1	TFL
Tall Meeting Table 30" depth x 41" high 		-	CHTMT6030 1,923	CHTMT6630 1,976	CHTMT7230 2,018	CHTMT7830 2,054	Code
			SEE NOTE 1	SEE NOTE 1	SEE NOTE 1	SEE NOTE 1	TFL

Note 1: Tables come with no power cut out. Click here to see tables with power cut outs.

All prices listed in USD \$
Ships KD = Knock Down (Assembly Required)

Finishes & Features Available...









TFL (1")	HD Highland Oak UM Urban Maple WH White WK Winter Oak SO Strata Oak CW Carini Walnut DN Denim LG Light Gray
Standard Top Features	Starter and Add on desks have scalloped cable access as standard Executive desks have a straight edge back edge as standard
Leg Colors	Silver White Black

To specify your desk...

1. Think through the configuration of Desk you require
2. Select the Codes of the individual items you need to achieve your configuration
3. Choose Finishes where appropriate: 'top' finishes / frame color / fabric color / acrylic color
4. Consider supporting product, screens, cable management and accessories

PRODUCT PRICING

CHEMISTRY MEETING TABLES – Goal Post Leg with Power Cutout

	Width (inch)					Code
	50" W	60" W	66" W	72" W	78" W	
Meeting Table with Oasis Cutout 50" Depth 	CHMT5050X 2,062	CHMT6050X 2,135	CHMT6650X 2,275	CHMT7250X 2,312	CHMT7850X 2,350	TFL
Add On Meeting Table with Oasis Cutout 50" Depth 	CHMT5050AX 1,425	CHMT6050AX 1,495	CHMT6650AX 1,637	CHMT7250AX 1,674	CHMT7850AX 1,713	TFL
Meeting Table with Oasis Cutout 62" Depth 	CHMT5062X 2,155	CHMT6062X 2,221	CHMT6662X 2,369	CHMT7262X 2,413	CHMT7862X 2,454	TFL
Add On Meeting Table with Oasis Cutout 62" Depth 	CHMT5062AX 1,488	CHMT6062AX 1,556	CHMT6662AX 1,704	CHMT7262AX 1,746	CHMT7862AX 1,790	TFL
Meeting Table with Cove Cutout 50" Depth 	CHMT5050Y 2,062	CHMT6050Y 2,135	CHMT6650Y 2,275	CHMT7250Y 2,312	CHMT7850Y 2,350	TFL
Add On Meeting Table with Cove Cutout 50" Depth 	CHMT5050AY 1,425	CHMT6050AY 1,495	CHMT6650AY 1,637	CHMT7250AY 1,674	CHMT7850AY 1,713	TFL
Meeting Table with Cove Cutout 62" Depth 	CHMT5062Y 2,155	CHMT6062Y 2,221	CHMT6662Y 2,369	CHMT7262Y 2,413	CHMT7862Y 2,454	TFL
Add On Meeting Table with Cove Cutout 62" Depth 	CHMT5062AY 1,488	CHMT6062AY 1,556	CHMT6662AY 1,704	CHMT7262AY 1,746	CHMT7862AY 1,790	TFL









All prices listed in USD \$
Ships KD = Knock Down (Assembly Required)

Finishes & Features Available...

TFL (1")	HD Highland Oak UM Urban Maple WH White WK Winter Oak SO Strata Oak CW Carini Walnut DN Denim LG Light Gray
Standard Top Features	Starter and Add on desks have scalloped cable access as standard Executive desks have a straight edge back edge as standard
Leg Colors	Silver White Black

PRODUCT PRICING

CHEMISTRY MEETING TABLES – 'O' Leg with Power Cutout

	Width (inch)					Code
	50" W	60" W	66" W	72" W	78" W	
Meeting Table with Oasis Cutout 50" Depth 	CHOMT5050X 2,589	CHOMT6050X 2,659	CHOMT6650X 2,800	CHOMT7250X 2,839	CHOMT7850X 2,877	TFL
Add On Meeting Table with Oasis Cutout 50" Depth 	CHMT5050AX 1,425	CHMT6050AX 1,495	CHMT6650AX 1,637	CHMT7250AX 1,674	CHMT7850AX 1,713	TFL
Meeting Table with Oasis Cutout 62" Depth 	CHOMT5062X 2,655	CHOMT6062X 2,715	CHOMT6662X 2,858	CHOMT7262X 2,911	CHOMT7862X 2,956	TFL
Add On Meeting Table with Oasis Cutout 62" Depth 	CHMT5062AX 1,488	CHMT6062AX 1,556	CHMT6662AX 1,704	CHMT7262AX 1,746	CHMT7862AX 1,790	TFL
Meeting Table with Cove Cutout 50" Depth 	CHOMT5050Y 2,589	CHOMT6050Y 2,659	CHOMT6650Y 2,800	CHOMT7250Y 2,839	CHOMT7850Y 2,877	TFL
Add On Meeting Table with Cove Cutout 50" Depth 	CHMT5050AY 1,425	CHMT6050AY 1,495	CHMT6650AY 1,637	CHMT7250AY 1,674	CHMT7850AY 1,713	TFL
Meeting Table with Cove Cutout 62" Depth 	CHOMT5062Y 2,655	CHOMT6062Y 2,715	CHOMT6662Y 2,868	CHOMT7262Y 2,911	CHOMT7862Y 2,956	TFL
Add On Meeting Table with Cove Cutout 62" Depth 	CHMT5062AY 1,488	CHMT6062AY 1,556	CHMT6662AY 1,704	CHMT7262AY 1,746	CHMT7862AY 1,790	TFL

All prices listed in USD \$
Ships KD = Knock Down (Assembly Required)

To specify your desk...

1. Think through the configuration of Desk you require
2. Select the Codes of the individual items you need to achieve your configuration
3. Choose Finishes where appropriate: 'top' finishes / frame color / fabric color / acrylic color
4. Consider supporting product, screens, cable management and accessories

CHEMISTRY MEETING TABLES – Desk Extensions / Storage Boxes

Desk Extension
16" Depth



Desk Extension
Storage Box
16" Depth
x 16" High



	Width (inch)		Code
	50"	62"	
Can be used on Goal Post Legs and 'O' Legs.	CHDE50 583	CHDE62 600	TFL
Can be used on Goal Post Legs and 'O' Legs.	CHDESB50 1,165	CHDESB62 1,199	TFL

CHEMISTRY MEETING TABLES – Cable Management

Double Cable Tray

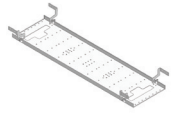

Double Cable Riser



Mid Leg Cable Riser

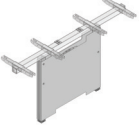

	Width (inch)					Code
	50" W	60" W	66" W	72" W	78" W	
SEE NOTE 1	CHDCT50 291	CHDCT60 327	CHDCT66 340	CHDCT72 351	CHDCT78 374	Price
SEE NOTE 1	SEE NOTE 1	SEE NOTE 1	SEE NOTE 1	SEE NOTE 1	SEE NOTE 1	
	CHCRD 320					Code
	SEE NOTE 1					Price
	CHLEGCM 378					Code
	SEE NOTE 2					Price

Note 1: Available in Black, White, and Silver.

Note 2: Only for use on the mid leg of "add on" meeting table sections.

All prices listed in USD \$

Ships KD = Knock Down (Assembly Required)

Finishes & Features Available...

TFL (1")	HD Highland Oak UM Urban Maple WH White WK Winter Oak SO Strata Oak CW Carini Walnut DN Denim LG Light Gray
Cable Management Colors	Silver White Black

CHEMISTRY MEETING TABLES – Power Modules

Stand Alone Oasis
Power Module

(4) Power, (3) Data
108" Power Cord
with 3 Prong Plug

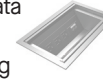

Stand Alone Cove
Power Module

(2) Power, (2) USB
Charging
108" Power Cord
with 3 Prong Plug



Daisy Chained Oasis
Power Module

(4) Power, (3) Data
Hardwired



Daisy Chained Cove
Power Module

(2) Power, (2) USB
Charging
Hardwired



Hardwire, multi
circuit infeeds for
daisy chaining



Jumper cables for
daisy chaining



	Width (inch)							Code
	50"	60"	66"	72"	78"	108"	144"	
OAS815X 1,985								Price
SEE NOTES 1 & 3								
COV25Y 460								Code
SEE NOTES 2 & 3								Price
OAS815DCX 2,251								Code
SEE NOTES 1 & 4								Price
COV25DCY 485								Code
SEE NOTES 2 & 4								Price
				72PWINF 138		108PWINF 175	144PWINF 214	Code
								Price
	50JUMP 129	60JUMP 141	66JUMP 147	72JUMP 154	78JUMP 159			Code
								Price

Note 1: Please specify desired finish color when ordering. (Black or Silver)

Note 2: Please specify desired finish color when ordering. (Black, White, or Silver)

Note 3: Cannot be daisy chained. Power Module comes standard with 108" power cord with 3 prong plug.

Note 4: Must be ordered with hardwire infeed and jumper cables to connect multiple power modules.

All prices listed in USD \$

Ships KD = Knock Down (Assembly Required)

To specify your desk...

1. Think through the configuration of Desk you require
2. Select the Codes of the individual items you need to achieve your configuration
3. Choose Finishes where appropriate: 'top' finishes / frame color / fabric color / acrylic color
4. Consider supporting product, screens, cable management and accessories

CHEMISTRY MEETING TABLES – AV Media Table / Tech Table

29"H x 39"D
AV Media Table

Dark gray frame
Black media
mounting display
Indesk power/AV



41"H x 39"D
AV Media Table

Dark gray frame
Black media
mounting display
Indesk power/AV



41"H x 48"D
Tech Table



In Desk Power

1x Power
2x USB Charging



Width (inch)			
80.5" W		TG8045M	Code
		15,130	TFL
		15,264	TFL w/ Whiteboard
		SEE NOTE 1	
80.5" W		TG8045H	Code
		15,499	TFL
		15,632	TFL w/ Whiteboard
		SEE NOTE 1	
Width (inch)			
130" W	165" W		Code
TT13048-KD	TT16548-KD		TFL
6,775	8,419		
SEE NOTES 1 & 2	SEE NOTES 1 & 2		
		IDPTT	Code
		334	Price

Note 1: Ships knockdown and requires assembly.
Note 2: Please specify Silver, Black, or White pulls

All prices listed in USD \$
Ships KD = Knock Down (Assembly Required)

Large grid area for notes.

Finishes & Features Available...

TFL (1") HD Highland Oak | UM Urban Maple | WH White | WK Winter Oak | SO Strata Oak | CW Carini Walnut | DN Denim | LG Light Gray

FINISHES

CHEMISTRY FINISHES – Standard Top Finishes – TFL



Carini Walnut



Strata Oak



Urban Maple



Highland Oak



Winter Oak

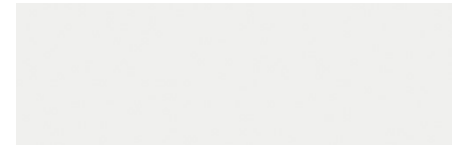

White

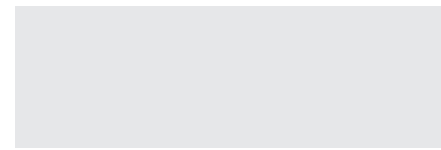

Light Gray



Denim

FRAME / LEG FINISHES



Black



White



Silver

Color images above are for reference only. Please verify with actual color sample.