

SENATOR

**CHEMISTRY HEIGHT
ADJUSTABLE**

CHEMISTRY PLUS HEIGHT ADJUSTABLE

Chemistry incorporates a height adjustable workstation solution to respond to the needs of today's office, where simple elegance and inherent functionality are a must to meet a multitude of applications. Chemistry Plus Height Adjustable desks make individual requirements possible, allowing the option to vary posture and stand while working.

Designed to fully interact with the user, whether seated or standing, height adjustable desks permit the user to quickly set their optimum working height by means of a responsive push button electronic mechanism.

CHEMISTRY PLUS HEIGHT ADJUSTABLE

STANDARD FEATURES

- Height adjustable steel frame
- Leveling adjustment
- Scalloped cable access
- 1" TFL rectangular tops
- Electric operations
- Anti Collision Sensor

SPECIFIABLE FEATURES

- Standalone or back to back

COMPLEMENTARY OPTIONS

- Universal Screens
- Cable trays and risers
- Desk linking kits

ACCESSORIES

- Monitor arms
- PU desk accessories
- Desk top accessories
- CPU holders
- Electrical accessories
- Screen accessories

PERFORMANCE STANDARDS

- Designed to conform to and where applicable is tested to the following standards:
- BIFMA X5.5 x2014
- SCS-EC10.3-2014 v. 3.0 Indoor Advantage Gold

DIMENSIONS

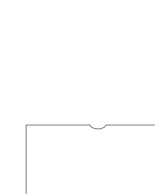
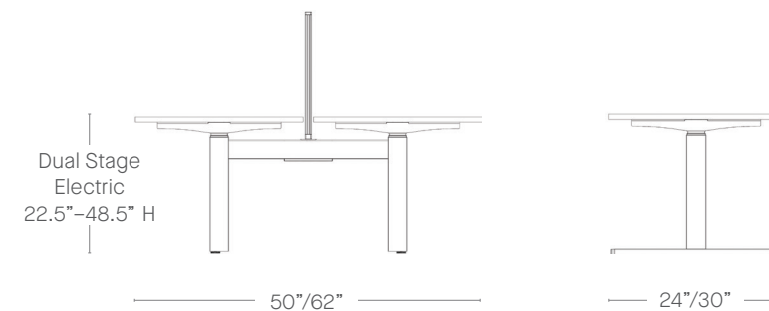

Single desk with I-leg
Widths. 48"-78"
Depths. 24" & 30"

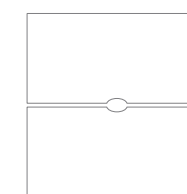

Back to back with H-leg
Widths. 48"-78"
Depths. 50" & 62"

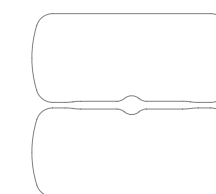

Pallet Top Back to back with H-leg
Widths. 60"-78"
Depths. 62"

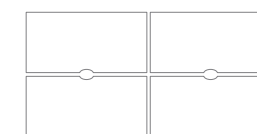

4 Person

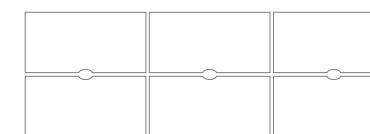

6 Person

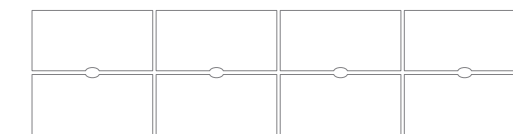

8 Person

CHEMISTRY PLUS HEIGHT ADJUSTABLE

1" Frame Height Adjustable

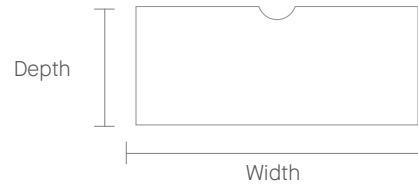

	48" W	54" W	60" W	66" W	72" W	78" W
24" D	●	●	●	●	●	●
30" D	●	●	●	●	●	●

Desk Mounted TFL Modesty Panels for Single Desks

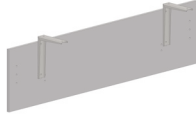

	48" W	54" W	60" W	66" W	72" W	78" W
14.5" H	●	●	●	●	●	●

Leg Mounted TFL Modesty Panels with Cable Tray for Single Desks

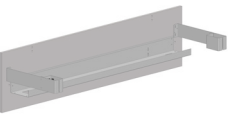

	48" W	54" W	60" W	66" W	72" W	78" W
14.5" H	●	●	●	●	●	●

Leg Mounted Cable Tray



	48" W	54" W	60" W	66" W	72" W	78" W
	●	●	●	●	●	●

CHEMISTRY PLUS HEIGHT ADJUSTABLE

Desktop Framed Screens for Single Desks

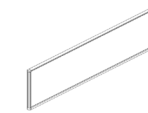

Desktop screen with Standard frame for single/inline height adjustable desk 16" high

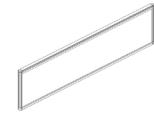

Desktop screen with single tool rail for single/inline height adjustable desk 16" high

	48" W	54" W	60" W	66" W	72" W	78" W
16" H	●	●	●	●	●	●

Desktop Frameless Screens for Single Desks

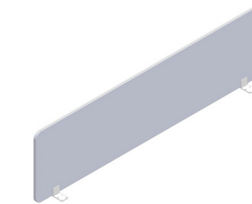
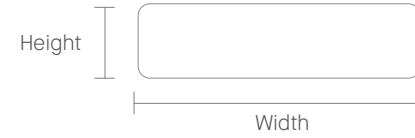

Desktop screen for single/inline height adjustable desk 16" high, complete with bracket

	48" W	54" W	60" W	66" W	72" W	78" W
16" H	●	●	●	●	●	●

Desk Mounted Screens for Single Desks

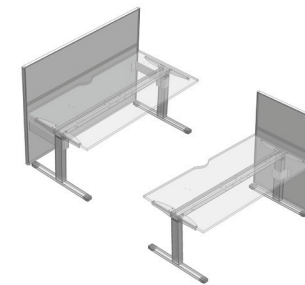

Desk Mounted Screen

	48" W	54" W	60" W	66" W	72" W	78" W
45" H	●	●	●	●	●	●

Desk End Screen

	24" W	30" W
45" H	●	●

CHEMISTRY PLUS HEIGHT ADJUSTABLE

'H' Frame Height Adjustable

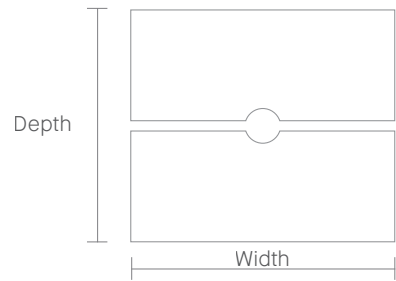

	48" W	54" W	60" W	66" W	72" W	78" W
50" D	●	●	●	●	●	●
62" D	●	●	●	●	●	●

Pallet Top Height Adjustable

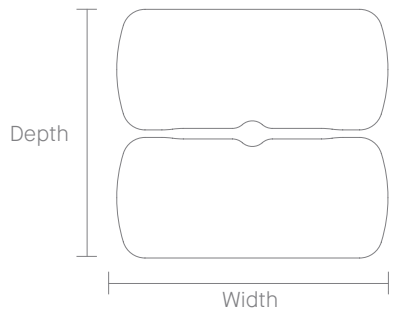

	60" W	72" W	78" W
62" D	●	●	●

Frame is inset 3" from each end of the work surface.

Executive Desk

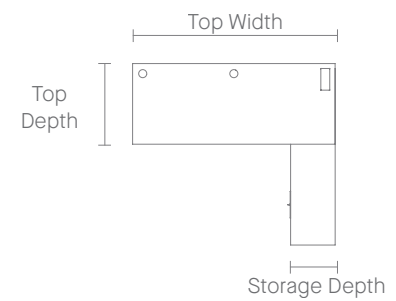

	72" W	78" W
18" D Storage	●	●
24" D Storage	●	●

Top Depth 30"

Desktop Framed Screens for Back to Back Benches



	48" W	54" W	60" W	66" W	72" W	78" W
26" H	●	●	●	●	●	●

Desktop screen with Standard frame for back to back height adjustable bench, 26" high, 45" from top to floor, complete with bracket

Desktop screen with single tool rail for back to back height adjustable bench, 26" high, 45" from top to floor, complete with bracket

CHEMISTRY PLUS HEIGHT ADJUSTABLE

Desktop Frameless Screens for Back to Back Benches



	48" W	54" W	60" W	66" W	72" W	78" W
26" H	●	●	●	●	●	●

Desktop screen for back to back height adjustable bench, 26" high, 45" from top to floor, complete with bracket.

Glass Screens for Back to Back Benches



	48" W	54" W	60" W	66" W	72" W	78" W
26" H	●	●	●	●	●	●

Desktop screen for back to back height adjustable bench, 26" high, 45" from top to floor. Rails specified separately.

Cable Trays for 'I' and 'H' Frames

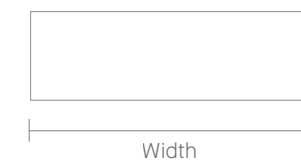

	48" W	54" W	60" W	66" W	72" W	78" W
	●	●	●	●	●	●

Cable Risers and Fixtures

Vertical cable riser for single desks.	Vertical cable riser for back to back benches.	Vertical cable chain	Screen attachment bracket pack comprising of two brackets	Desk linking kit comprising of two brackets

CHEMISTRY PLUS HEIGHT ADJUSTABLE

SINGLE DESK

- Upper Cable Tray**
Cable trays are available to manage power options.
- Cable Riser**
An optional cable riser is available to manage power from the floor to the upper or lower cable tray.
- Leg Mounted Modesty with Cable Tray**
Cable trays are available to manage power options.
- Single Desk Frame**
A powder coated welded framework with height adjustable columns.

BACK TO BACK BENCH

- Upper Cable Tray**
Cable trays are available to manage power options.
- Cable Trough**
Included with all back to back benches. Fixed to the underside of the frame to manage power.
- Cable Chain**
An optional cable chain is available to manage power from the lower cable trough to the upper cable tray.
- Cable Riser**
Used when power is fed from the floor to the cable trough. The cable riser is bolted to the underside of the trough.
- Bench Frame**
A powder coated welded framework with height adjustable columns.

WORK SURFACES

On single desks, one top is supplied per starter or add on desk.
On back to back benches, two tops are supplied per bench.

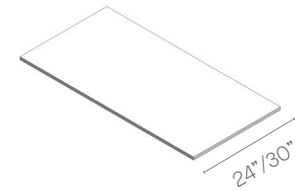

Chemistry Plus tops are available with 24" or 30" depths and lengths of 48", 54", 60", 66", 72", and 78".



Tops are available in TFL with a scallop in the back for cable access.

TFL tops have a 2mm laser edge band all around.

FRAMEWORK

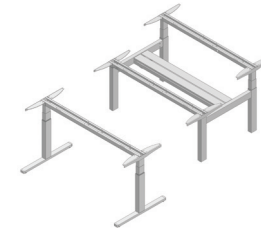

Electric Desk Frame
Dual Stage Electric desks have a height adjustment of 22.5" - 48.5"

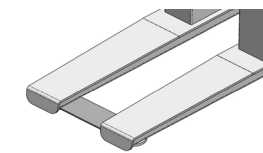

Desk Linking Kits
Linking kits are available to align height adjustable workstations in a straight row.
The kits create and hold a 1" gap between workstations, eliminating potential pinch points. Kits are available for both inline desks, and back to back benches.



Electric Chemistry Executive Desk Frame
The electric desk has a working range of 29" - 48.5" high.
This can be adjusted electronically via a desk switch.
The height adjustable single legs have a larger foot surface to add stability to the desk.

CABLE MANAGEMENT



Optional cable trays are available that hang underneath the desktop. These allow for power blocks to be laid inside and cables fixed in place. This improves safety and keeps the under desk space tidy.

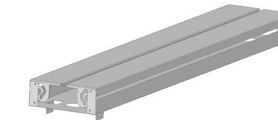

The cable trough is mounted between the lower frame on back to back benches. The trough is the entry point for power and data into the bench and provides an enclosure for power blocks and wires. Slide on covers conceal power and wiring.

*Not available for single height adjustable desking

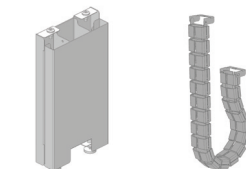

An optional vertical cable manager is available to allow power and data to be taken from the floor to the cable trough. The riser attaches to the end of the cable trough to ensure a tidy transfer of cables. Optional flexible plastic cable chains are available to provide a secure way to manage power and data cabling from the trough up to the cable tray.

SCREENS

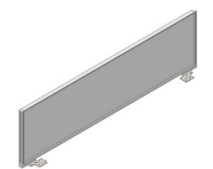

Screens are available to divide up benches and hang accessories. The screens are fixed to the height adjustable bench frame or fixed to the underside of the work surface on the single desks with metal brackets. Fabric, TFL, Acrylic, and Glass screen options are available.

CHEMISTRY EXECUTIVE DESKING - STORAGE



18" deep storage unit comes complete with 1x personal drawer, 1x filing drawer, open storage with shelves, a cubby for a PC with port hole access and integrated vertical cable management system.



24" deep storage unit comes complete with 1x personal drawer, 1x filing drawer, open storage with shelves, a cubby for a PC with port hole access and integrated vertical cable management system.

Filing drawer comes complete with filing cradle to support letter filing.

CHEMISTRY PLUS HEIGHT ADJUSTABLE

TYPICAL "I"-LEG DESK WIRING LAYOUT.

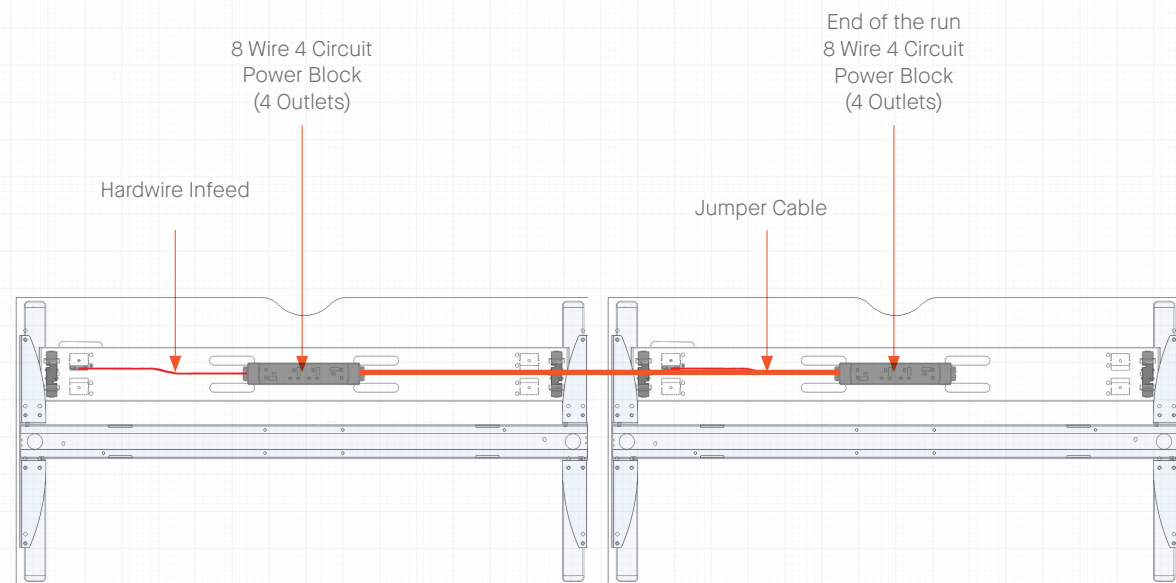
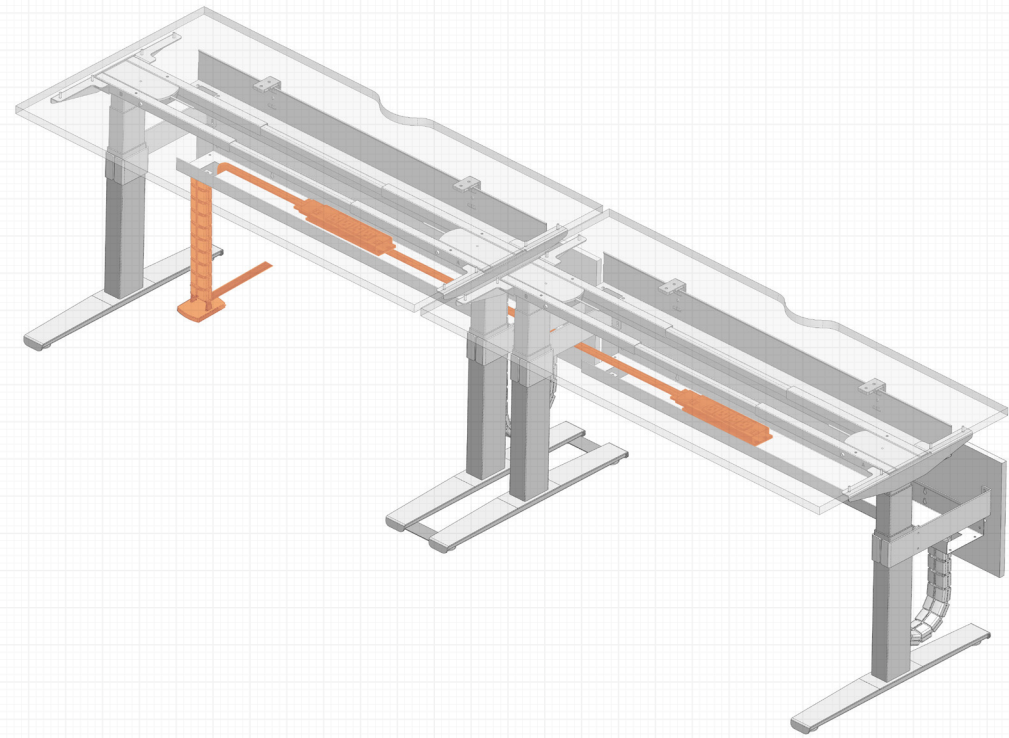

CHEMISTRY PLUS HEIGHT ADJUSTABLE

TYPICAL "H"-LEG DESK WIRING LAYOUT.

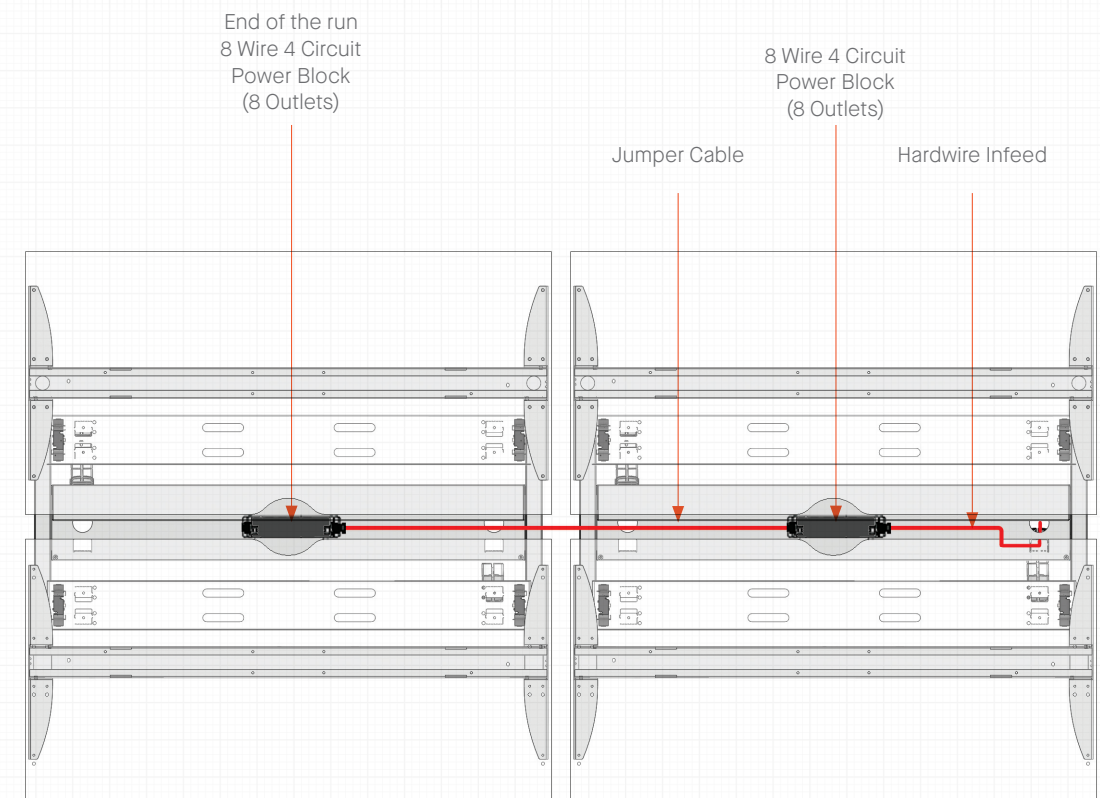
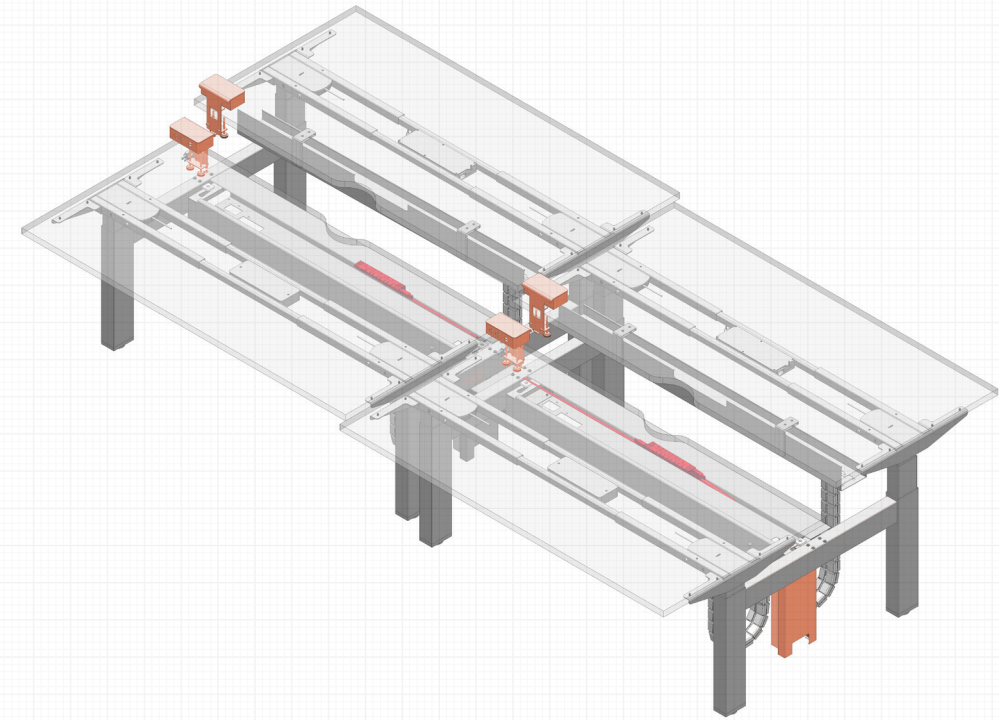

PRODUCT PRICING

CHEMISTRY PLUS HEIGHT ADJUSTABLE – Single Desk

		Width (inch)						
		48" W	54" W	60" W	66" W	72" W	78" W	
<p>Single HA Dual Stage 24" Depth</p>	Height adjustable between 22.5" - 48.5"	CHPDSAE4824 1,654	CHPDSAE5424 1,666	CHPDSAE6024 1,677	CHPDSAE6624 1,691	CHPDSAE7224 1,699	CHPDSAE7824 1,711	Code TFL
<p>Single HA Dual Stage 30" Depth</p>	Height adjustable between 22.5" - 48.5"	CHPDSAE4830 1,694	CHPDSAE5430 1,707	CHPDSAE6030 1,722	CHPDSAE6630 1,737	CHPDSAE7230 1,749	CHPDSAE7830 1,763	Code TFL
<p>Surface Mounted Modesty Panel</p>	Mounts to the underside of the worksurface	CHPAMW48 343	CHPAMW54 353	CHPAMW60 363	CHPAMW66 375	CHPAMW72 388	CHPAMW78 397	Code TFL
		SEE NOTE 1	SEE NOTE 1	SEE NOTE 1	SEE NOTE 1	SEE NOTE 1	SEE NOTE 1	SEE NOTE 1
<p>Desk Mounted Cable Tray</p>	One required per desktop	CHPDSACT48 155	CHPDSACT54 164	CHPDSACT60 177	CHPDSACT66 189	CHPDSACT72 220	CHPDSACT78 239	Code Price
		SEE NOTE 2	SEE NOTE 2	SEE NOTE 2	SEE NOTE 2	SEE NOTE 2	SEE NOTE 2	SEE NOTE 2
<p>Vertical Cable Riser</p>	Carries cables from floor to Cable Tray or directly to the work surface	FBAVCM 148						Code Price
		SEE NOTE 2						
<p>Vertical Cable Chain</p>	Carries cables from the Leg Mounted Cable Tray to the Desk Mounted Cable Tray	FBABVCM 148						Code Price
		SEE NOTE 2						
<p>CPU Holder HA Desk</p>	Mounts to underside of desk to hold computer tower	CHPMUSCPUH 306						Code Price
		SEE NOTE 2						
<p>Inline Desk Linking Kit</p>	Connects two single desk frames to create a 1" gap between work surfaces for safety	CHPUSAEDLNK 175						Code Price
		SEE NOTE 2						

Note 1: Available in all TFL finishes

Note 2: Specify black, white, or silver metalwork.

All prices listed in USD \$

Ships KD = Knock Down (Assembly Required)

Finishes & Features Available...

TFL (1")	HD Highland Oak UM Urban Maple WH White WK Winter Oak SO Strata Oak CW Carini Walnut DN Denim LG Light Gray
Standard Top Features	Starter and Add on desks have scalloped cable access as standard Executive desks have a straight edge back edge as standard
Leg Colors	Silver White Black

PRODUCT PRICING

CHEMISTRY PLUS HEIGHT ADJUSTABLE – Cable Management

		Width (inch)						
		48" W	54" W	60" W	66" W	72" W	78" W	
<p>Stationary Leg Mounted Cable Tray 24" Depth</p>		CHP24LMSCT48 490	CHP24LMSCT54 498	CHP24LMSCT60 511	CHP24LMSCT66 524	CHP24LMSCT72 557	CHP24LMSCT78 574	Code Price
		SEE NOTE 2	SEE NOTE 2	SEE NOTE 2	SEE NOTE 2	SEE NOTE 2	SEE NOTE 2	SEE NOTE 2
<p>Stationary Leg Mounted Modesty Panel with Cable Tray 24" Depth</p>		CHP24LMAMW48 597	CHP24LMAMW54 606	CHP24LMAMW60 616	CHP24LMAMW66 629	CHP24LMAMW72 641	CHP24LMAMW78 651	Code Price
		SEE NOTES 1 & 2	SEE NOTES 1 & 2	SEE NOTES 1 & 2	SEE NOTES 1 & 2	SEE NOTES 1 & 2	SEE NOTES 1 & 2	SEE NOTES 1 & 2
<p>Stationary Leg Mounted Cable Tray 30" Depth</p>		CHP30LMSCT48 503	CHP30LMSCT54 512	CHP30LMSCT60 523	CHP30LMSCT66 537	CHP30LMSCT72 569	CHP30LMSCT78 586	Code Price
		SEE NOTE 2	SEE NOTE 2	SEE NOTE 2	SEE NOTE 2	SEE NOTE 2	SEE NOTE 2	SEE NOTE 2
<p>Stationary Leg Mounted Modesty Panel with Cable Tray 30" Depth</p>		CHP30LMAMW48 609	CHP30LMAMW54 620	CHP30LMAMW60 630	CHP30LMAMW66 641	CHP30LMAMW72 654	CHP30LMAMW78 664	Code Price
		SEE NOTES 1 & 2	SEE NOTES 1 & 2	SEE NOTES 1 & 2	SEE NOTES 1 & 2	SEE NOTES 1 & 2	SEE NOTES 1 & 2	SEE NOTES 1 & 2

Note 1: Panel available in all TFL finishes

Note 2: Frame available in Black, White, and Silver

All prices listed in USD \$

Ships KD = Knock Down (Assembly Required)

To specify your desk...

1. Think through the configuration of Desk you require
2. Select the Codes of the individual items you need to achieve your configuration
3. Choose Finishes where appropriate: 'top' finishes / frame color / fabric color / acrylic color
4. Consider supporting product, screens, cable management and accessories

CHEMISTRY PLUS HEIGHT ADJUSTABLE – Single Desk Screens

Desktop Screen w/
Standard Frame Single/
Inline HA Desk
16" High



Width (inch)					
48" W	54" W	60" W	66" W	72" W	78" W
US1648	US1654	US1660	US1666	US1672	US1678
428	447	464	506	520	541
626	666	693	709	742	777
499	524	554	574	591	616
541	566	603	626	649	675
639	674	723	761	791	824
SEE NOTES 1 & 2	SEE NOTES 1 & 2	SEE NOTES 1 & 2	SEE NOTES 1 & 2	SEE NOTES 1 & 2	SEE NOTES 1 & 2

Code
TFL
Acrylic
Grade A
Grade B
Grade C

Desktop Screen w/
Single Tool Rail for
Single/Inline HA Desk
16" High



UST1648	UST1654	UST1660	UST1666	UST1672	UST1678
443	461	479	518	533	554
639	680	707	723	755	791
514	539	566	586	605	630
554	581	615	639	662	689
653	687	738	775	806	839
SEE NOTES 1 & 2	SEE NOTES 1 & 2	SEE NOTES 1 & 2	SEE NOTES 1 & 2	SEE NOTES 1 & 2	SEE NOTES 1 & 2

Code
TFL
Acrylic
Grade A
Grade B
Grade C

Screen Fixing Bracket Back
Comprising of two brackets

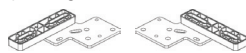

CHFBKT1					
100					
SEE NOTES 1 & 3					

Code
Price

Desktop Screen
Frameless Non-Pinnable
16" High
Supplied with
Fixing Brackets



CHPSF1648	CHPSF1654	CHPSF1660	CHPSF1666	CHPSF1672	CHPSF1678
472	482	497	510	527	537
510	522	545	560	581	596
605	626	660	682	718	739
SEE NOTE 1	SEE NOTE 1	SEE NOTE 1	SEE NOTE 1	SEE NOTE 1	SEE NOTE 1

Code
Grade A
Grade B
Grade C

Desktop Screen
Frameless Pinnable
16" High
Supplied with
Fixing Brackets



CHPSF1648P	CHPSF1654P	CHPSF1660P	CHPSF1666P	CHPSF1672P	CHPSF1678P
564	609	641	667	700	726
602	650	685	717	755	784
697	752	803	839	891	928
SEE NOTE 1	SEE NOTE 1	SEE NOTE 1	SEE NOTE 1	SEE NOTE 1	SEE NOTE 1

Code
Grade A
Grade B
Grade C

Note 1: Specify black, white, or silver metalwork.

All prices listed in USD \$

Note 2: Must be ordered with CHFBKT1 bracket for single desks. Fixes to desk top.

Ships KD = Knock Down (Assembly Required)

Note 3: To be used on single desks with framed desktop screens.

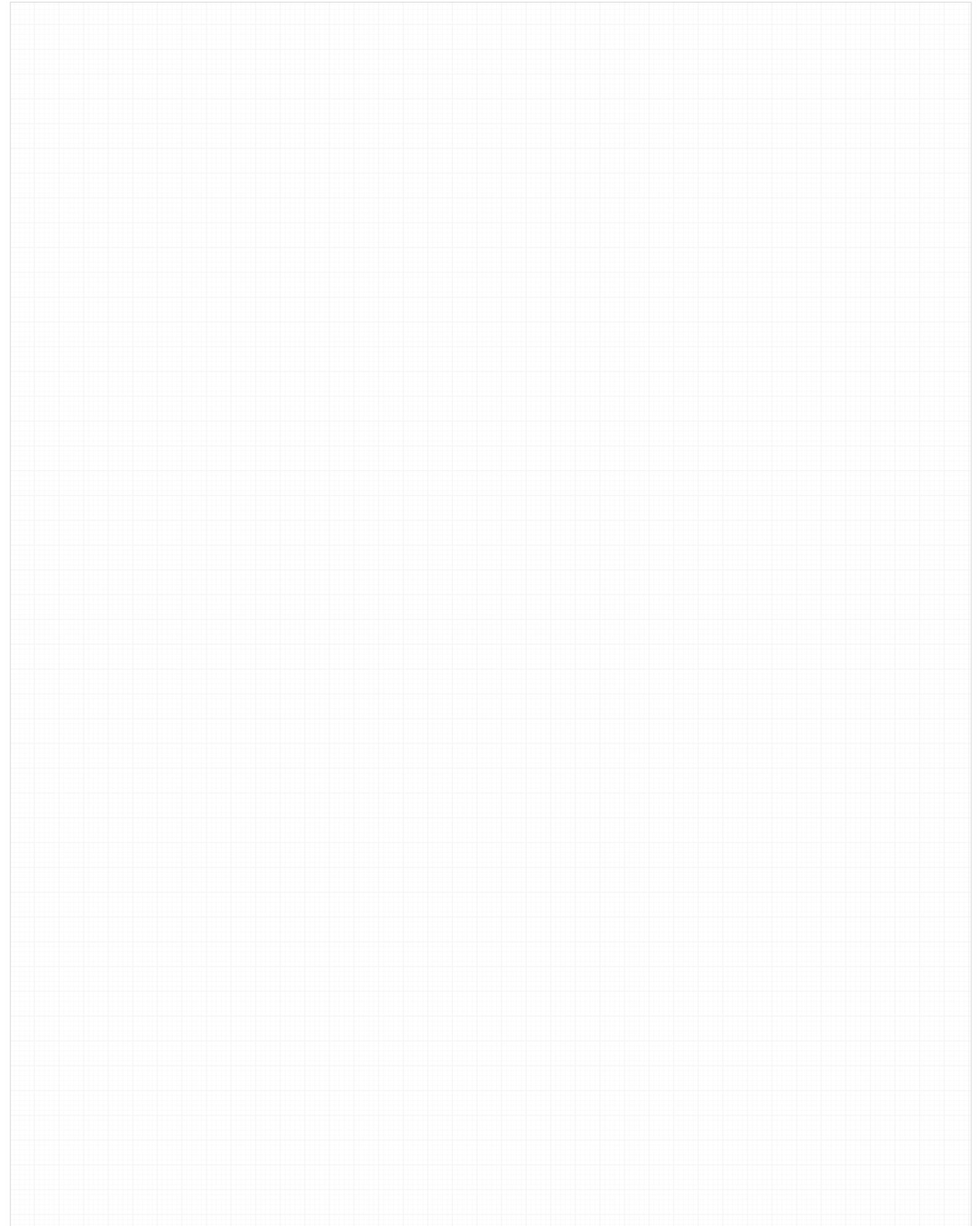

Finishes & Features Available...

TFL (1")	HD Highland Oak UM Urban Maple WH White WK Winter Oak SO Strata Oak CW Carini Walnut DN Denim LG Light Gray
Frame Colors	Silver White Black
Fabrics	Grade A Camira Era Grade B Camira Lucia, Camira Nexus Grade C Camira Blazer, Camira Blazer Lite, Camira Aquarius, Camira Main Line Flax, Camira Synergy, Camira Synergy 66
Acrylic Colors	Clear Opaque Crystal Opaque White Opaque Green Opaque Blue



PRODUCT PRICING

CHEMISTRY PLUS HEIGHT ADJUSTABLE DESK – Desk Mounted Screens 24” D Desks

		Width (inch)							
		48" W	54" W	60" W	66" W	72" W	78" W		
24" D Desk Mounted HA Single Desk Screen w/ Standard Frame and Cable Tray 45" High 		CHP24SC4548	CHP24SC4554	CHP24SC4560	CHP24SC4566	CHP24SC4572	CHP24SC4578	Code	
		1,322	1,344	1,384	1,418	1,450	1,487	TFL	
		1,480	1,533	1,582	1,652	1,696	1,827	Grade A	
		1,589	1,660	1,719	1,805	1,859	2,007	Grade B	
		1,867	1,982	2,058	2,188	2,263	2,456	Grade C	
	SEE NOTE 1	SEE NOTE 1	SEE NOTE 1	SEE NOTE 1	SEE NOTE 1	SEE NOTE 1	SEE NOTE 1		
24" D Desk Mounted HA Single Desk Screen w/ Tool Rail and Cable Tray 45" High 		CHP24STC4548	CHP24STC4554	CHP24STC4560	CHP24STC4566	CHP24STC4572	CHP24STC4578	Code	
		1,334	1,357	1,398	1,430	1,463	1,501	TFL	
		1,493	1,559	1,594	1,663	1,709	1,842	Grade A	
		1,604	1,674	1,730	1,817	1,872	2,020	Grade B	
		1,881	1,995	2,045	2,202	2,278	2,468	Grade C	
	SEE NOTE 1	SEE NOTE 1	SEE NOTE 1	SEE NOTE 1	SEE NOTE 1	SEE NOTE 1	SEE NOTE 1		
24" D Desk Mounted HA Single Desk Screen w/ Standard Frame 45" High 		CHP24S4548	CHP24S4554	CHP24S4560	CHP24S4566	CHP24S4572	CHP24S4578	Code	
		1,169	1,190	1,231	1,264	1,297	1,334	TFL	
		1,326	1,379	1,428	1,497	1,543	1,675	Grade A	
		1,437	1,508	1,564	1,652	1,706	1,853	Grade B	
		1,714	1,827	1,906	2,036	2,111	2,301	Grade C	
	SEE NOTE 1	SEE NOTE 1	SEE NOTE 1	SEE NOTE 1	SEE NOTE 1	SEE NOTE 1	SEE NOTE 1		
24" D Desk Mounted HA Single Desk Screen w/ Tool Rail 45" High 		CHP24ST4548	CHP24ST4554	CHP24ST4560	CHP24ST4566	CHP24ST4572	CHP24ST4578	Code	
		1,182	1,205	1,244	1,279	1,310	1,348	TFL	
		1,341	1,394	1,442	1,512	1,556	1,689	Grade A	
		1,450	1,521	1,579	1,663	1,720	1,867	Grade B	
		1,726	1,843	1,918	2,049	2,123	2,315	Grade C	
	SEE NOTE 1	SEE NOTE 1	SEE NOTE 1	SEE NOTE 1	SEE NOTE 1	SEE NOTE 1	SEE NOTE 1		
Depth (inch)									
24"									
24" D Desk Mounted HA Single Desk End Screen w/ Standard Frame 45" High 		CHPDE4524						Code	
		947						TFL	
		1,045						Grade A	
		1,108						Grade B	
		1,282						Grade C	
		SEE NOTE 1							
24" D Desk Mounted HA Single Desk End Screen w/ Tool Rail 45" High 		CHPDET4524						Code	
		960						TFL	
		1,056						Grade A	
		1,121						Grade B	
		1,294						Grade C	
		SEE NOTE 1							
4 Way Linking Post with Adjustable Foot 45" High 		US4WPST45						Code	
		154						Price	
		SEE NOTE 1							

Note 1: Specify black, white, or silver metalwork.

All prices listed in USD \$

Ships KD = Knock Down (Assembly Required)

Finishes & Features Available...

TFL (1")	HD Highland Oak UM Urban Maple WH White WK Winter Oak SO Strata Oak CW Carini Walnut DN Denim LG Light Gray
Frame Colors	Silver White Black
Fabrics	Grade A Camira Era Grade B Camira Lucia, Camira Nexus Grade C Camira Blazer, Camira Blazer Lite, Camira Aquarius, Camira Main Line Flax, Camira Synergy, Camira Synergy 66

PRODUCT PRICING

CHEMISTRY PLUS HEIGHT ADJUSTABLE DESK – Desk Mounted Screens 30” D Desks

		Width (inch)							
		48" W	54" W	60" W	66" W	72" W	78" W		
30" D Desk Mounted HA Single Desk Screen w/ Standard Frame and Cable Tray 45" High 		CHP30SC4548	CHP30SC4554	CHP30SC4560	CHP30SC4566	CHP30SC4572	CHP30SC4578	Code	
		1,334	1,357	1,398	1,430	1,463	1,501	TFL	
		1,493	1,559	1,594	1,663	1,709	1,842	Grade A	
		1,604	1,674	1,730	1,817	1,872	2,020	Grade B	
		1,881	1,995	2,045	2,202	2,278	2,468	Grade C	
	SEE NOTE 1	SEE NOTE 1	SEE NOTE 1	SEE NOTE 1	SEE NOTE 1	SEE NOTE 1	SEE NOTE 1		
30" D Desk Mounted HA Single Desk Screen w/ Tool Rail and Cable Tray 45" High 		CHP30STC4548	CHP30STC4554	CHP30STC4560	CHP30STC4566	CHP30STC4572	CHP30STC4578	Code	
		1,348	1,372	1,412	1,445	1,477	1,514	TFL	
		1,506	1,573	1,609	1,678	1,723	1,855	Grade A	
		1,616	1,687	1,745	1,830	1,885	2,034	Grade B	
		1,893	2,008	2,058	2,214	2,290	2,482	Grade C	
	SEE NOTE 1	SEE NOTE 1	SEE NOTE 1	SEE NOTE 1	SEE NOTE 1	SEE NOTE 1	SEE NOTE 1		
30" D Desk Mounted HA Single Desk Screen w/ Standard Frame 45" High 		CHP30S4548	CHP30S4554	CHP30S4560	CHP30S4566	CHP30S4572	CHP30S4578	Code	
		1,182	1,205	1,244	1,279	1,310	1,348	TFL	
		1,341	1,394	1,443	1,512	1,556	1,689	Grade A	
		1,450	1,521	1,578	1,663	1,720	1,867	Grade B	
		1,726	1,843	1,918	2,049	2,123	2,315	Grade C	
	SEE NOTE 1	SEE NOTE 1	SEE NOTE 1	SEE NOTE 1	SEE NOTE 1	SEE NOTE 1	SEE NOTE 1		
30" D Desk Mounted HA Single Desk Screen w/ Tool Rail 45" High 		CHP30ST4548	CHP30ST4554	CHP30ST4560	CHP30ST4566	CHP30ST4572	CHP30ST4578	Code	
		1,193	1,217	1,258	1,291	1,324	1,360	TFL	
		1,352	1,407	1,457	1,523	1,570	1,703	Grade A	
		1,462	1,535	1,592	1,677	1,641	1,881	Grade B	
		1,740	1,853	1,932	2,060	2,138	2,327	Grade C	
	SEE NOTE 1	SEE NOTE 1	SEE NOTE 1	SEE NOTE 1	SEE NOTE 1	SEE NOTE 1	SEE NOTE 1		
Depth (inch)									
30"									
30" D Desk Mounted HA Single Desk End Screen w/ Standard Frame 45" High 		CHPDE4530						Code	
		980						TFL	
		1,096						Grade A	
		1,172						Grade B	
		1,358						Grade C	
		SEE NOTE 1							
30" D Desk Mounted HA Single Desk End Screen w/ Tool Rail 45" High 		CHPDET4530						Code	
		994						TFL	
		1,110						Grade A	
		1,186						Grade B	
		1,373						Grade C	
		SEE NOTE 1							
4 Way Linking Post with Adjustable Foot 45" High 		US4WPST45						Code	
		154						Price	
		SEE NOTE 1							

All prices listed in USD \$

Ships KD = Knock Down (Assembly Required)

To specify your desk...

1. Think through the configuration of Desk you require
2. Select the Codes of the individual items you need to achieve your configuration
3. Choose Finishes where appropriate: *top* finishes / frame color / fabric color / acrylic color
4. Consider supporting product, screens, cable management and accessories

CHEMISTRY PLUS SINGLE HEIGHT ADJUSTABLE DESK – Screen Attachment

60" x 30" workstations

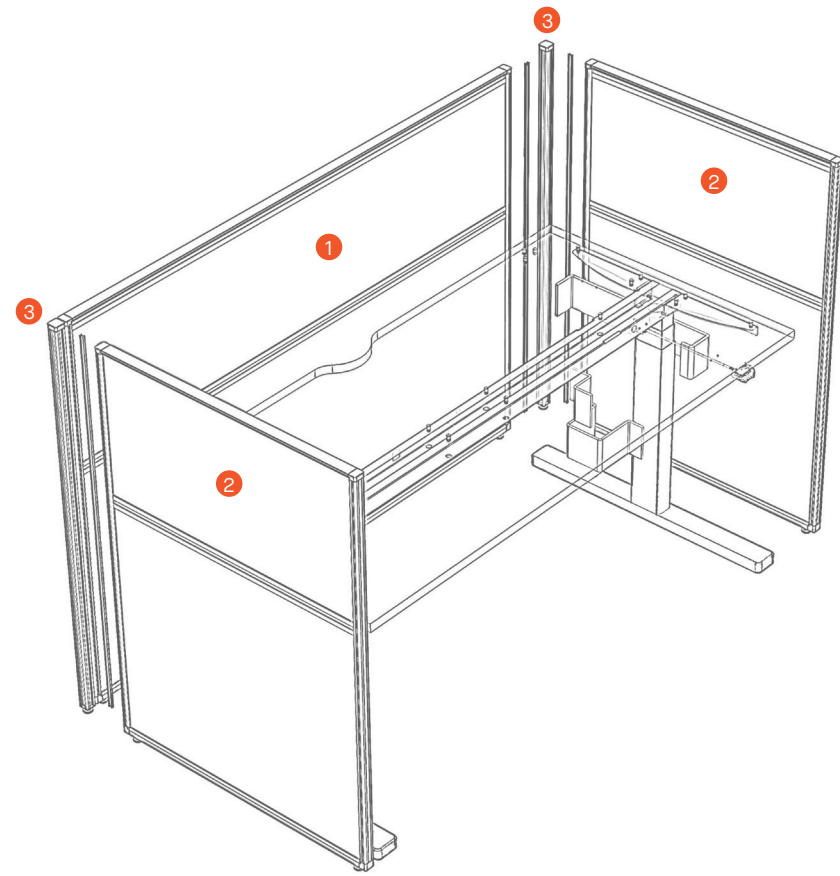

	Code	Description	QTY
1	CHP30ST4560	Desk Mounted HA Desk Screen	1
2	CHPDET4530	Desk Mounted HA Single Desk End Screen	2
3	US4WPST45	4-Way Linking Post Supplied with adjustable foot	2

CHEMISTRY PLUS BACK TO BACK HEIGHT ADJUSTABLE BENCH – Screen Attachment

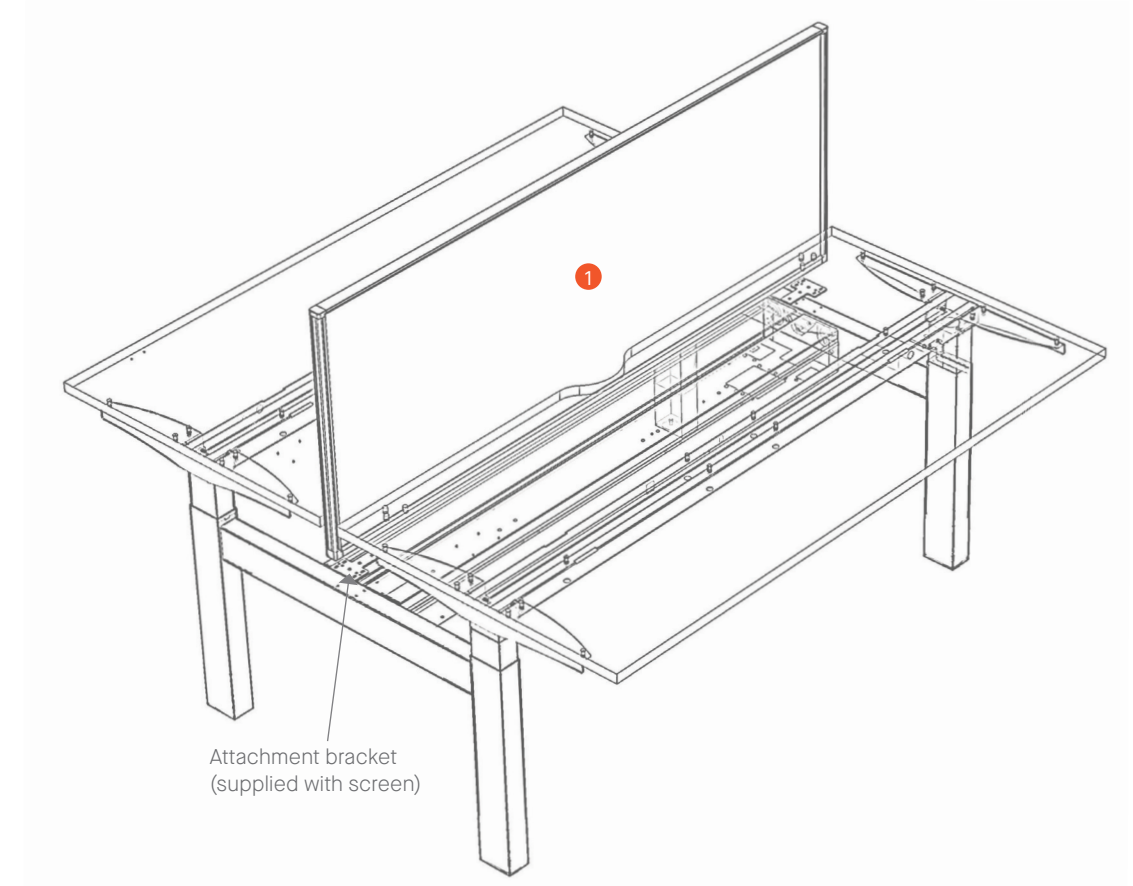

	Code	Description	QTY
1	CHPUSHA2660	Desktop Screen with Standard Frame for HA Bench Supplied with attachment bracket	1

PRODUCT PRICING

CHEMISTRY PLUS HEIGHT ADJUSTABLE – Back to Back Bench

		Width (inch)						
		48" W	54" W	60" W	66" W	72" W	78" W	
<p>Back to Back Bench HA Dual Stage 50" Depth</p>	Height adjustable between 22.5" – 48.5"	CHPDSAEB4850 3,770	CHPDSAEB5450 3,820	CHPDSAEB6050 3,858	CHPDSAEB6650 3,915	CHPDSAEB7250 3,965	CHPDSAEB7850 4,015	Code TFL
	Height adjustable between 22.5" – 48.5"	CHPDSAEB4862 3,833	CHPDSAEB5462 3,903	CHPDSAEB6062 3,930	CHPDSAEB6662 3,958	CHPDSAEB7262 3,985	CHPDSAEB7862 4,095	Code TFL
<p>Desk Mounted Cable Tray</p>	One required per desktop	CHPDSACT48 155 SEE NOTE 1	CHPDSACT54 164 SEE NOTE 1	CHPDSACT60 177 SEE NOTE 1	CHPDSACT66 189 SEE NOTE 1	CHPDSACT72 220 SEE NOTE 1	CHPDSACT78 239 SEE NOTE 1	Code Price
	Carries cables from desk mounted cable tray to bench trough	FBABVCM 148 SEE NOTE 1						Code Price
<p>Vertical Cable Riser</p>	Conceals cables from bench trough to the floor	CHPUSACRD 279 SEE NOTE 1						Code Price
	Mounts to underside of desk to hold computer tower	CHPMUSCPUH 306 SEE NOTE 1						Code Price
<p>Back to Back Linking Tray & Cover</p>	Connects bench frames to create a 1" gap between work surfaces for safety	CHPUSAEBLNK 175 SEE NOTE 1						Code Price

Note 1: Available in Black, White, and Silver.

All prices listed in USD \$
Ships KD = Knock Down (Assembly Required)

Finishes & Features Available...

TFL (1")	HD Highland Oak UM Urban Maple WH White WK Winter Oak SO Strata Oak CW Carini Walnut DN Denim LG Light Gray
Standard Top Features	Starter desks have scalloped cable access as standard
Leg / Cable Management Color	Silver White Black
Fabrics	Grade A Camira Era Grade B Camira Lucia, Camira Nexus Grade C Camira Blazer, Camira Blazer Lite, Camira Aquarius, Camira Main Line Flax, Camira Synergy, Camira Synergy 66
Acrylic Colors	Clear Opaque Crystal Opaque White Opaque Green Opaque Blue
Glass Colors	Clear Gray Smoked

PRODUCT PRICING

CHEMISTRY PLUS HEIGHT ADJUSTABLE – Back to Back Bench Screens

		Width (inch)						
		48" W	54" W	60" W	66" W	72" W	78" W	
<p>Desktop Screen w/ Standard Frame for Back to Back HA Supplied with Fixing Bracket 26" High</p>	Code TFL	CHPUSHA2648 663 918 789 862 1,046 SEE NOTES 1 & 2	CHPUSHA2654 684 961 828 912 1,125 SEE NOTES 1 & 2	CHPUSHA2660 704 992 856 963 1,181 SEE NOTES 1 & 2	CHPUSHA2666 714 1,051 899 1,005 1,275 SEE NOTES 1 & 2	CHPUSHA2672 738 1,127 932 1,009 1,331 SEE NOTES 1 & 2	CHPUSHA2678 765 1,170 984 1,062 1,396 SEE NOTES 1 & 2	Code TFL Acrylic Grade A Grade B Grade C
	Code TFL	CHPUSTA2648 675 932 801 876 1,060 SEE NOTES 1 & 2	CHPUSTA2654 698 975 841 927 1,139 SEE NOTES 1 & 2	CHPUSTA2660 718 1,003 882 977 1,220 SEE NOTES 1 & 2	CHPUSTA2666 726 1,064 911 1,020 1,289 SEE NOTES 1 & 2	CHPUSTA2672 751 1,140 945 1,022 1,344 SEE NOTES 1 & 2	CHPUSTA2678 776 1,184 997 1,073 1,410 SEE NOTES 1 & 2	Code TFL Acrylic Grade A Grade B Grade C
<p>Desktop Screen Frameless Non-Pinnable Supplied with Fixing Bracket 26" High</p>	Code Grade A Grade B Grade C	CHPSF2648 531 607 800 SEE NOTE 2	CHPSF2654 552 633 839 SEE NOTE 2	CHPSF2660 580 673 905 SEE NOTE 2	CHPSF2666 600 699 943 SEE NOTE 2	CHPSF2672 628 736 1,010 SEE NOTE 2	CHPSF2678 648 763 1,049 SEE NOTE 2	Code Grade A Grade B Grade C
	Code Grade A Grade B Grade C	CHPSF2648P 731 808 998 SEE NOTE 2	CHPSF2654P 773 854 1,057 SEE NOTE 2	CHPSF2660P 823 916 1,148 SEE NOTE 2	CHPSF2666P 865 963 1,209 SEE NOTE 2	CHPSF2672P 908 1,026 1,299 SEE NOTE 2	CHPSF2678P 961 1,074 1,361 SEE NOTE 2	Code Grade A Grade B Grade C
<p>Desktop Glass Screen 26" High</p>	Code Price	CHGSHA2648 574 SEE NOTE 3	CHGSHA2654 624 SEE NOTE 3	CHGSHA2660 726 SEE NOTE 3	CHGSHA2666 744 SEE NOTE 3	CHGSHA2672 783 SEE NOTE 3	CHGSHA2678 840 SEE NOTE 3	Code Price
	Code Price	CHGSHAR48 460 SEE NOTE 2	CHGSHAR54 475 SEE NOTE 2	CHGSHAR60 489 SEE NOTE 2	CHGSHAR66 561 SEE NOTE 2	CHGSHAR72 588 SEE NOTE 2	CHGSHAR78 619 SEE NOTE 2	Code Price

Note 1: For use on back to back HA desks. (Includes fixing bracket to desk frame, do not order brackets separately). Stands 45" high from floor when fitted.

Note 2: Specify black, white, or silver metalwork.

Note 3: Specify Clear or Gray Smoked Glass. Must be ordered with a glass screen rail.

All prices listed in USD \$
Ships KD = Knock Down (Assembly Required)

To specify your desk...

1. Think through the configuration of Desk you require
2. Select the Codes of the individual items you need to achieve your configuration
3. Choose Finishes where appropriate: 'top' finishes / frame color / fabric color / acrylic color
4. Consider supporting product, screens, cable management and accessories

PRODUCT PRICING

CHEMISTRY PLUS HEIGHT ADJUSTABLE – Back to Back Pallet Bench

Back to Back Pallet Bench HA Dual Stage Electric
62" Depth



	Width (inch)			Code
	60" W	72" W	78" W	
Height adjustable between 22.5" - 48.5"	CHPDSAEP6062 3,963	CHPDSAEP7262 4,019	CHPDSAEP7862 4,099	TFL

Desk Mounted Cable Tray



	Width (inch)			Code
	54" W	66" W	72" W	
One required per desktop	CHPDSACT54 164 SEE NOTES 1 & 4	CHPDSACT66 189 SEE NOTES 2 & 4	CHPDSACT72 220 SEE NOTES 3 & 4	Price

Vertical Cable Chain



Carries cables from desk mounted cable tray to bench trough	FBABVCM 148 SEE NOTE 4			Code Price
---	-------------------------------------	--	--	---------------

Vertical Cable Riser



Conceals cables from bench trough to the floor	CHPUSACRD 279 SEE NOTE 4			Code Price
--	---------------------------------------	--	--	---------------

CPU Holder HA Desk



Mounts to underside of desk to hold computer tower	CHPMUSCPUH 306 SEE NOTE 4			Code Price
--	--	--	--	---------------

Back to Back Linking Tray & Cover

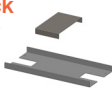

Connects desk frames to create a 1" gap between work surface for safety	CHPUSAEPBLNK 238 SEE NOTE 4			Code Price
---	--	--	--	---------------

Note 1: For use with 60" W Back to Back Pallet Bench Only

Note 2: For use with 72" W Back to Back Pallet Bench Only

Note 3: For use with 78" W Back to Back Pallet Bench Only

Note 4: Available in Black, White, and Silver.

All prices listed in USD \$

Ships KD = Knock Down (Assembly Required)

Finishes & Features Available...

TFL (1")	HD Highland Oak UM Urban Maple WH White WK Winter Oak SO Strata Oak CW Carini Walnut DN Denim LG Light Gray
Standard Top Features	Pallet benches have scalloped cable access as standard Executive desks have a straight edge back edge as standard
Leg / Cable Management Colors	Silver White Black

PRODUCT PRICING

CHEMISTRY PLUS HEIGHT ADJUSTABLE – Executive Desk

Executive Desk

18" Depth Storage
74" Overall Depth



Executive Desk

24" Depth Storage
74" Overall Depth



Desk Top (inch)		Code
72" x 30"	78" x 30"	
CHAE723ONS 7,346 SEE NOTES 1, 2, & 3	CHAE783ONS 7,509 SEE NOTES 1, 2, & 3	TFL
CHAE723ODS 7,471 SEE NOTES 1, 2, & 3	CHAE783ODS 7,627 SEE NOTES 1, 2, & 3	TFL

Note 1: All integrated cable management.

Note 2: Please specify left (L) or right (R) hand version when ordering. Right hand shown.

Note 3: For integrated port holes, please add an extra \$250. Port holes are located at the front left, center, and right of the desk. Add "P" to the end of the item code (ie: CHAE723ONSP-R)

All prices listed in USD \$

Ships KD = Knock Down (Assembly Required)

To specify your desk...

1. Think through the configuration of Desk you require
2. Select the Codes of the individual items you need to achieve your configuration
3. Choose Finishes where appropriate: 'top' finishes / frame color / fabric color / acrylic color
4. Consider supporting product, screens, cable management and accessories

CHEMISTRY ACCESSORIES

Clear and organized spaces are known for enhancing efficiency in the office, Senator's range of desk accessories provide a place for everything to maximize productivity at the workstation. Seamlessly integrating with the Chemistry range, the variety of accessories available from pen pots and whiteboards to tablet holders are designed to support the diverse needs of different working styles, by allowing users to personalize their own workspaces.

CHEMISTRY ACCESSORIES

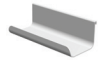
<p>Pen Pot with Rail Holder</p> 	<p>DAPPH 72</p> <p>SEE NOTE 1</p>	Code Price
<p>Pen Tray</p> 	<p>DAPT 61</p> <p>SEE NOTE 1</p>	Code Price
<p>Tablet Holder</p> 	<p>DATH 55</p> <p>SEE NOTE 1</p>	Code Price
<p>Paper Tray Hanger</p> 	<p>DAPTHA4 95</p> <p>SEE NOTE 1</p>	Code Price
<p>Paper Tray</p> 	<p>DAPTA4 67</p> <p>SEE NOTE 1</p>	Code Price
<p>Hanger for Magnetic White Board</p> 	<p>DAWBH 47</p> <p>SEE NOTE 1</p>	Code Price
<p>Magnetic White Board 8.25in x 11.75in</p> 	<p>DAWBA4 164</p> <p>SEE NOTE 1</p>	Code Price
<p>Magnetic White Board 11.75in x 6.5in</p> 	<p>DAWBA3 206</p> <p>SEE NOTE 1</p>	Code Price

Note 1: Only available in White.

All prices listed in USD \$

DESK ACCESSORIES

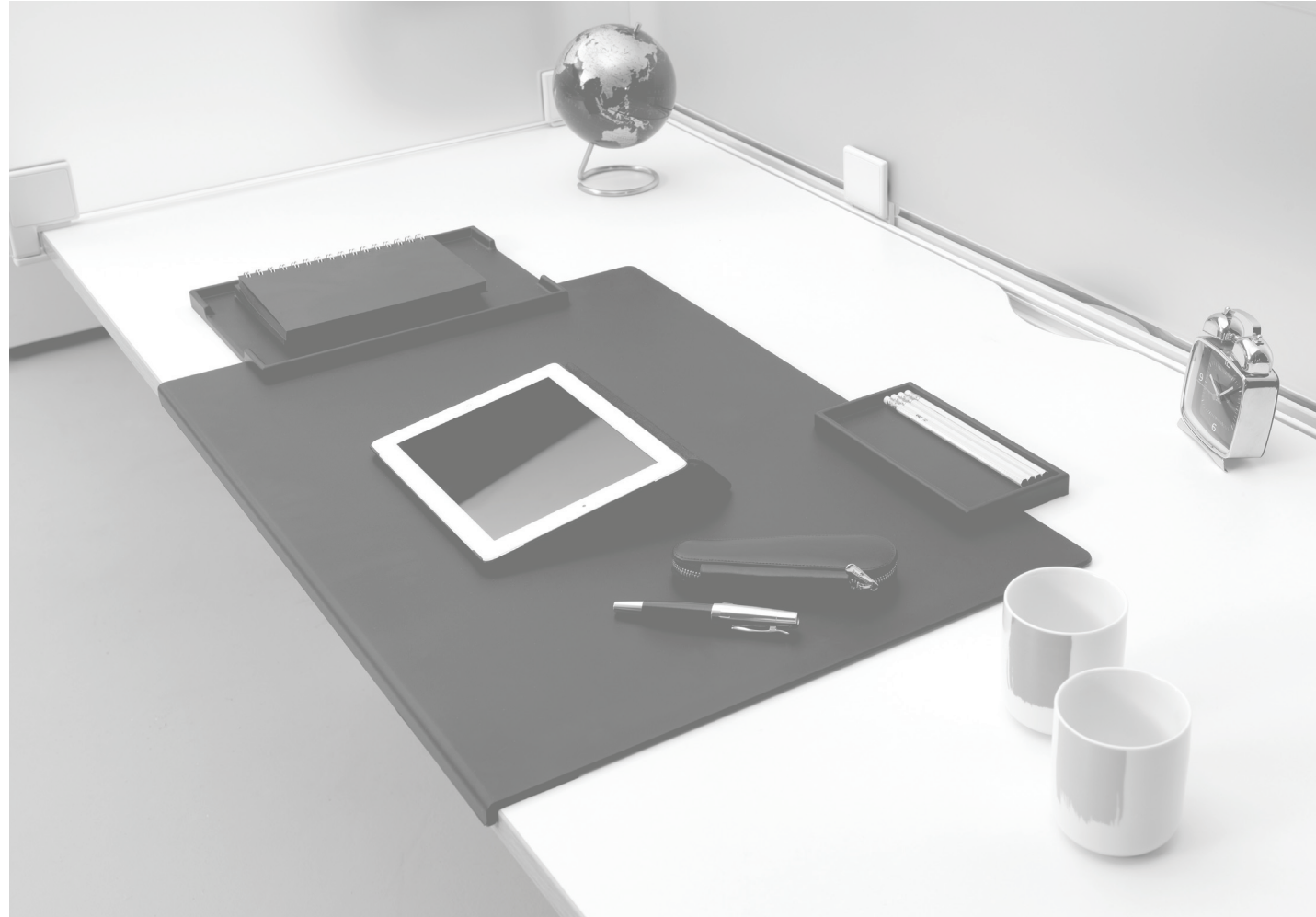

Organizing Desk Pad

30" x 20.5"

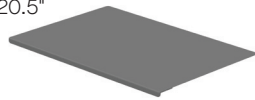

Organizing Desk Pad Accessory Set

Paper tray / pen tray / cupholder



DAM01	Code
262	Price
SEE NOTE 1	
DAMACC	Code
342	Price
SEE NOTE 1	

Note 1: Only available in Black.

All prices listed in USD \$

DESK ACCESSORIES



White Board Desk Divider Clip



Magnetic White Board

8.25in x 11.75in



Magnetic White Board

11.75in x 6.5in



Single Binder Holder with Pen Pot



Binder Holder



DAWBDC	Code
30	Price
SEE NOTE 1	
DAWBA4	Code
164	Price
SEE NOTE 1	
DAWBA3	Code
206	Price
SEE NOTE 1	
DABHPP	Code
98	Price
SEE NOTE 1	
DABH	Code
138	Price
SEE NOTE 1	

Note 1: Only available in White.

All prices listed in USD \$

CHEMISTRY DESK ACCESSORIES

M2 Desk Mounted Adjustable Monitor Arm

Please specify DC if desk clamped or CP for cableport fixed. Suitable for 1" tops.



M2CLF17DC 638 SEE NOTE 1	M2CLF17CP 638 SEE NOTE 1	Code
		Price
ADPSC 423 SEE NOTE 2		Code
		Price
ADPSS 484		Code
		Price

Note 1: All monitor arms are compatible with most flat screen monitors. Please ensure monitors have VESA mounting. Consult with the Sales Office for more details.

Note 2: Available in White or Black. Please specify when ordering.

All prices listed in USD \$

Above Desk Power (3-Prong Plug)

- Above Table
- White or Black
- Two power outlets
- 1 powered USB-A
- 1 powered USB-C
- 10 ft power cord w/ 3-prong plug



Above Desk Power (Hardwire)

- Above Table
- White or Black
- Two power outlets
- 1 powered USB-A
- 1 powered USB-C
- 10 ft hardwire infeed



CHEMISTRY POWER

84 System Hardwire Infeeds 8 Wire 4 Circuit

For Single, Inline, and Bench desk power block options



Single Desk Electrical Kit

- 1x power block
- 4x receptacles
- 1x jumper cable

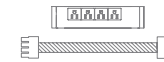

Single Desk End of Run Block

- 1x power block
- 4x receptacles



84 System Hardwire Infeeds 8 Wire 4 Circuit

- 1x power block
- 8x receptacles
- 1x jumper cable

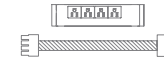

84 System Hardwire Infeeds 8 Wire 4 Circuit

- 1x power block
- 8x receptacles



Length (inches)		
72"	108"	144"
72HWINF84 231	108HWINF84 296	144HWINF84 363

Single/Inline Desk Power Blocks					
Length (inches)					
48"	54"	60"	66"	72"	78"
EK48SB8W4C 372 SEE NOTE 1	EK54SB8W4C 382	EK60SB8W4C 393	EK66SB8W4C 405	EK72SB8W4C 416	EK78SB8W4C 426

EKEORSSB 197					
-------------------------------	--	--	--	--	--

Bench Desk Power Blocks					
Length (inches)					
48"	54"	60"	66"	72"	78"
EK48DSB8W4C 467 SEE NOTE 2	EK54DSB8W4C 479	EK60DSB8W4C 490	EK66DSB8W4C 499	EK72DSB8W4C 512	EK78DSB8W4C 522

EKEORDSB 279					
-------------------------------	--	--	--	--	--

Note 1: If ordering 120 degree single desks, you must specify a 48" single desk electrical kit.

Note 2: If ordering 120 degree back to back bench desks, you must specify bench desk electrical kit.

All prices listed in USD \$

FINISHES

CHEMISTRY FINISHES – Standard Top Finishes – TFL



Carini Walnut



Strata Oak



Urban Maple



Highland Oak



Winter Oak

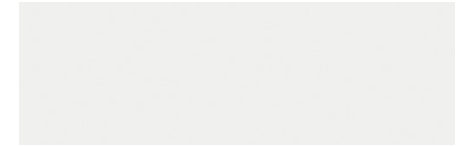

White



Light Gray



Denim

CHEMISTRY FINISHES

CONTRASTING EDGE BAND



Ply Effect Edging

All TFL (Edge 69) tops come with a matching edge band as standard. Contrasting edge band can be specified.

Please contact customer service if you require a contrasting edge band.



FRAME / LEG FINISHES

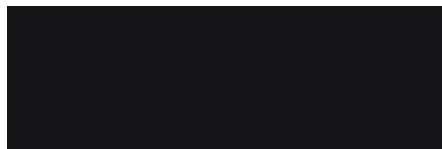

Black

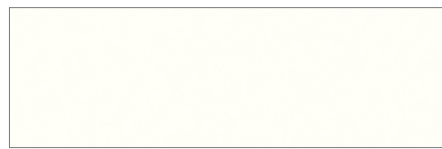

White

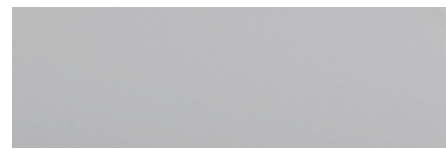

Silver

STANDARD PANEL FINISHES – Acrylic



Clear

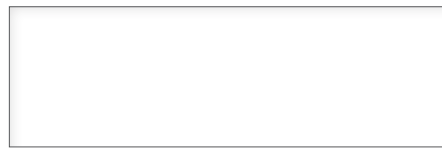

Opaque Crystal

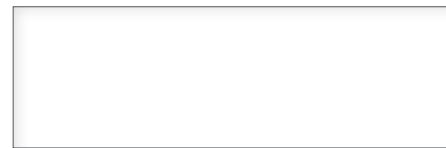

Opaque White



Opaque Green

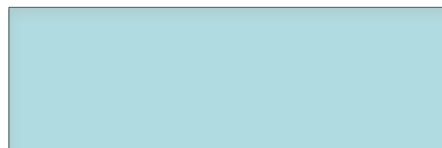

Opaque Blue

GLASS SCREEN FINISHES



Clear



Gray Smoked

CHEMISTRY MEETING TABLES

STANDARD FEATURES (*Selected models only)

- 2" square Steel tube legs with mitred corners
- 1/4" shadow gap between top and frame
- Universally sized Steel dual crossrails
- Leveling feet
- 1" TFL rectangular tops

SPECIFIABLE FEATURES

- In-desk power modules*

OPTIONAL FEATURES

- Desk extensions*
- Storage boxes*
- Cable trays and risers*

PERFORMANCE STANDARDS

- Designed to conform to and where applicable is tested to the following standards:
- BIFMA X5.5 x2014
 - SCS-EC10.3-2014 v. 3.0 Indoor Advantage Gold

CHEMISTRY MEETING TABLES

Chemistry meeting tables share the same frame as Chemistry workstations for consistent design aesthetics. Designed as a response to the demand for workspaces that are flexible and collaborative, Chemistry meeting tables are efficient and streamlined, creating an atmosphere that can be both formal and informal.

DIMENSIONS

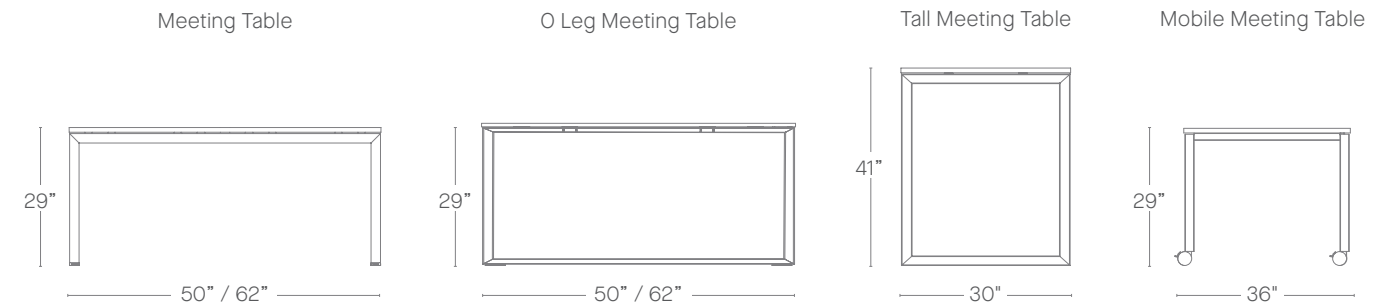

Meeting Table
Widths. 50"-78"
Depths. 50" or 62"

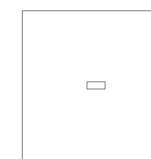

Meeting Table with Power
Widths. 50"-78"
Depths. 50" or 62"

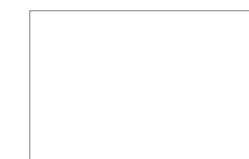

Tall Meeting Table
Widths. 62"-78"
Depths. 30"



Mobile Meeting Table
Widths. 36"
Depths. 36"

CHEMISTRY MEETING TABLES

● Available
□ Not available

Meeting Table

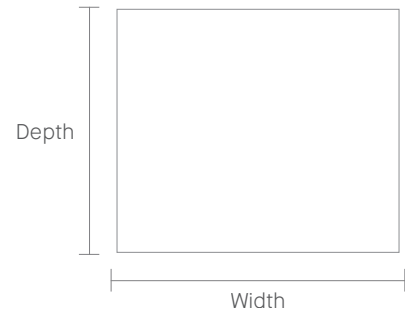

50" / 62" Deep Table



	50" W	60" W	66" W	72" W	78" W
50" D	●	●	●	●	●
62" D	●	●	●	●	●

Meeting Table with Power

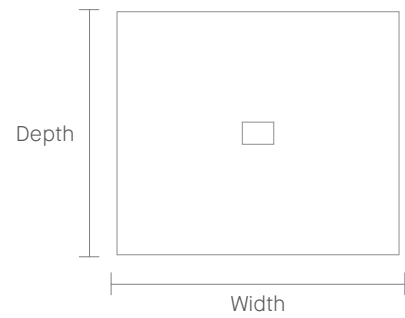

50" / 62" Deep Table with Power



	50" W	60" W	66" W	72" W	78" W
50" D	●	●	●	●	●
62" D	●	●	●	●	●

CHEMISTRY MEETING TABLES

● Available
□ Not available

Extensions and Storage Boxes



Extension



16" high storage box



16" D	50" W	62" W
	●	●

Power Modules

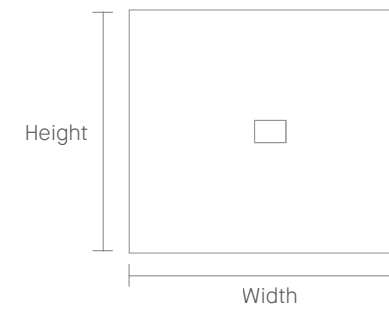

OAS815X / OAS815DCX

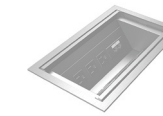

COV15Y / COV15DCY



	Power Outlets	USB Charging	Data
OAS815X / OAS815DCX	●	-	●
COV15Y / COV15DCY	●	●	-

Cable Trays



Double Cable Tray

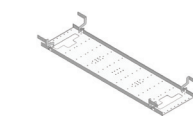

50" W	60" W	66" W	72" W	78" W
●	●	●	●	●

Cable Risers

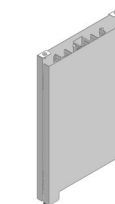

Double Cable Riser

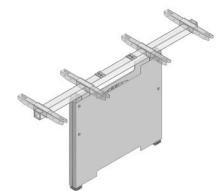

Mid Leg Cable riser

CHEMISTRY MEETING TABLES

● Available
□ Not available

Tall Meeting Table



	60" W	66" W	72" W	78" W
30" D	●	●	●	●

Mobile Meeting Table

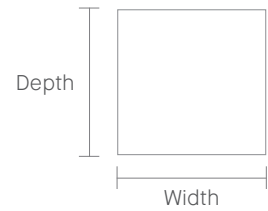

	36" W
36" D	●

CHEMISTRY ANCILLARY TABLES

● Available
□ Not available

AV Media Table



42" D	29" H	41" H
49" W	●	●

Tech Table



48" D	130" W	165" W
41" H	●	●

Not supplied with monitor arm and display

Accessories



M2 Monitor Arm



In Desk Power
(1 Power, 2 USB
Charging)

CHEMISTRY MEETING TABLES – Goal Post Leg

50" / 62" MEETING TABLE

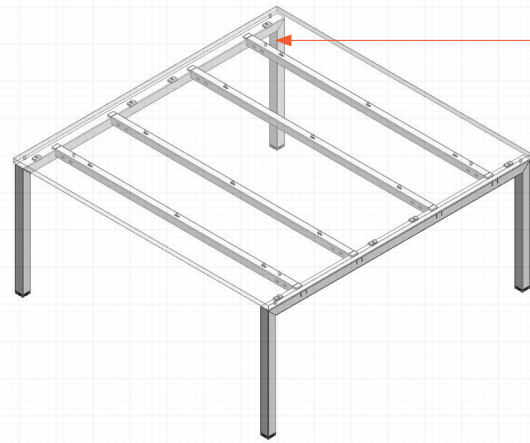

50" or 62" Meeting Table
Large meeting tables comprise of (2) end legs, (4) beams and (1) work surface.

50" / 62" MEETING TABLE WITH POWER

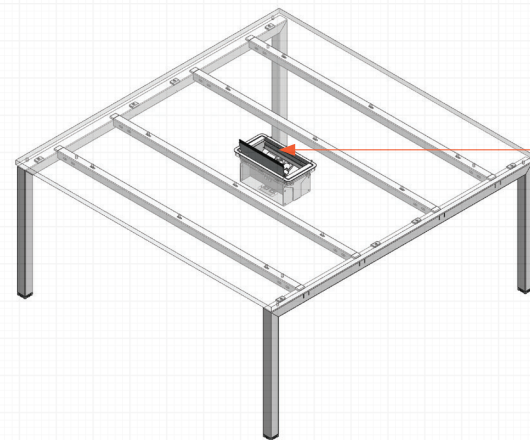

50" or 62" Meeting Table with Power
Large meeting tables comprise of (2) end legs, (4) beams and (1) work surface.
Optional In desk power modules can be ordered with (4) power and (3) data, or (2) power and (2) USB charging.
Optional In desk power modules can be ordered with a 108" power cord with 3 prong plug, or daisy chained together with a hardwire infeed and jumper cable.

50" / 62" MEETING TABLE WITH MID LEG

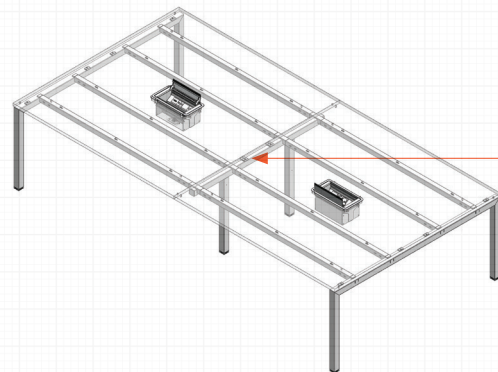

Mid Leg Meeting Table
Similar to Chemistry desking, meeting tables can be connected using a mid leg. You can link as many tables as necessary to complete your configuration.

WORK SURFACES

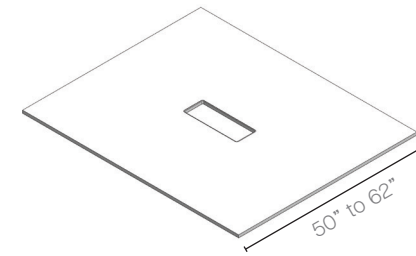

Chemistry meeting table tops are available in 50", and 62" depths and lengths of 50", 60", 66", 72", and 78".
Tops are available in TFL and can be cut to take optional power units.
TFL tops have a 2mm edge band all around.

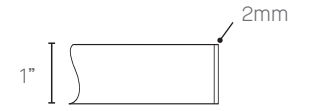

FRAMEWORK



End Legs
End legs are 50" or 62" wide. Each end leg has spigots protruding from the frame to allow the beams to be bolted into place. Adjustable feet come standard.



Mid Legs
Mid legs are used to connect starter desks and add on desks. They have double sided spigots to attach beams to both sides and come with adjustable feet as standard.



Beams
Beams are Steel box tubes used to connect the legs together. They bolt at each end to the spigots and also through to the top.
Beams come in lengths of 50", 60", 66", 72", and 78".

FRAMEWORK

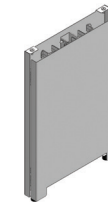

Double Cable Riser
A Double cable riser or Mid leg cable riser is available to transport power from the ground up to the underside of the optional power modules.

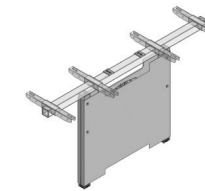

Mid Leg Cable Riser

POWER MODULES

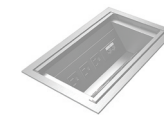

OAS815X
(4) Power, (3) Data
108" 3 Prong Plug



COV15Y
(2) Power, (2) USB Charging
108" 3 Prong Plug

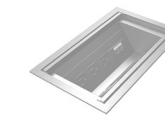

OAS815DCX
(4) Power, (3) Data
Hardwire Infeed



COV15Y
(2) Power, (2) USB Charging
Hardwire Infeed

CHEMISTRY TALL MEETING TABLES

TALL MEETING TABLES

Tall Meeting Tables are designed to facilitate flexible and diverse workspaces, allowing a change of posture during the work day

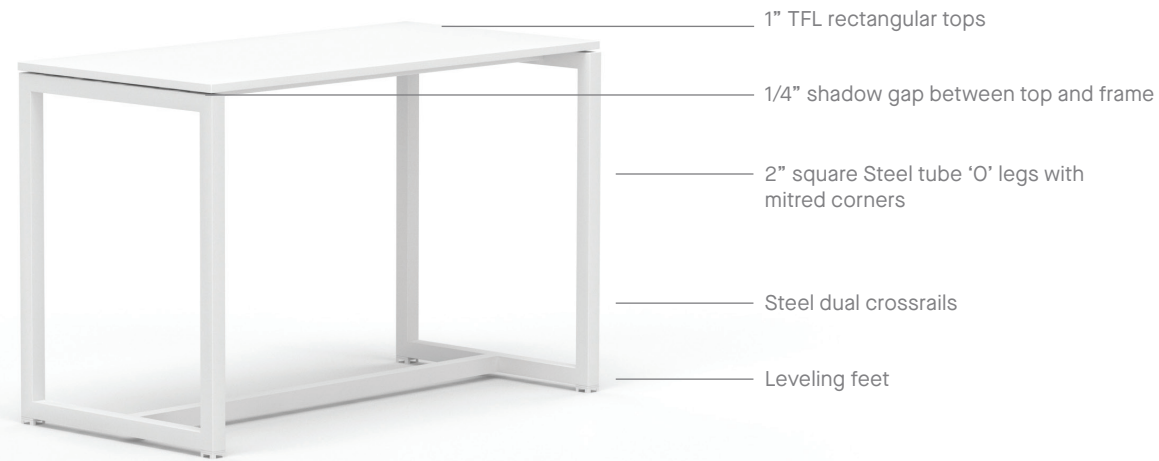

DIMENSIONS

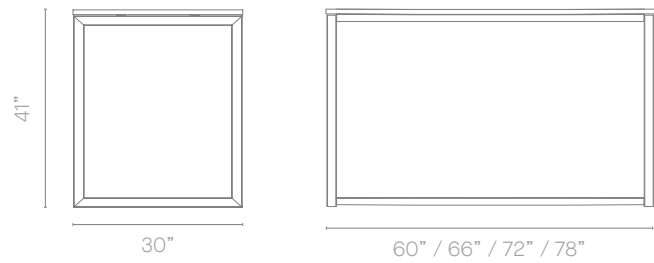

FEATURES



Plastic molded leveling feet, offering 1" of adjustment

CHEMISTRY MOBILE MEETING TABLES

MOBILE MEETING TABLES

Mobile Meeting Tables are elegantly designed and well engineered. Combining functionality and style, they are ideal for a variety of applications.

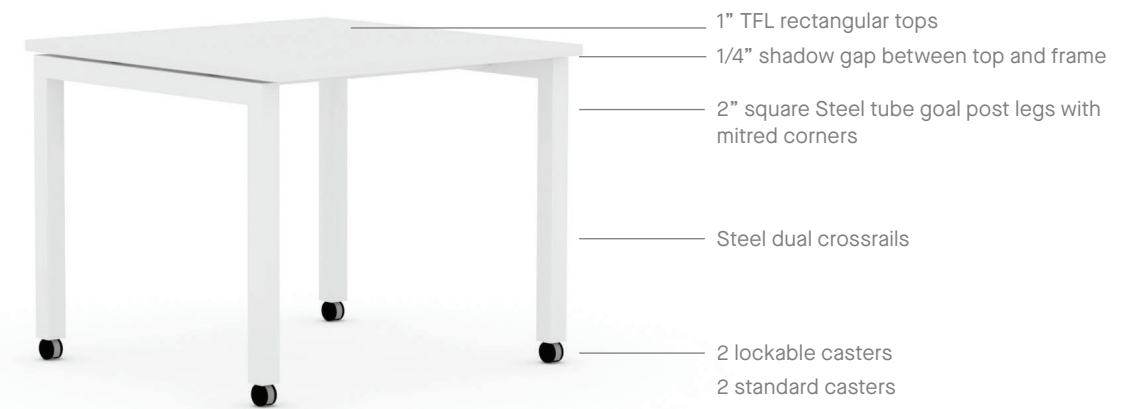

DIMENSIONS

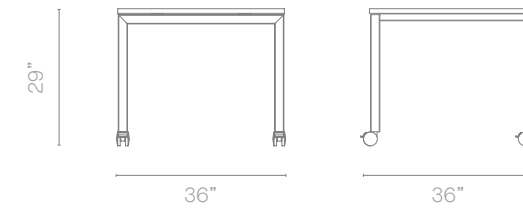

FEATURES



Lockable casters allow unit to be easily relocated and firmly held in position while in use

CHEMISTRY ANCILLARY TABLES

AV MEDIA TABLE

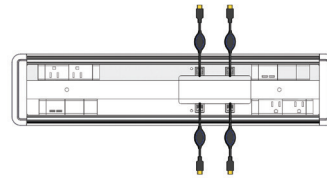
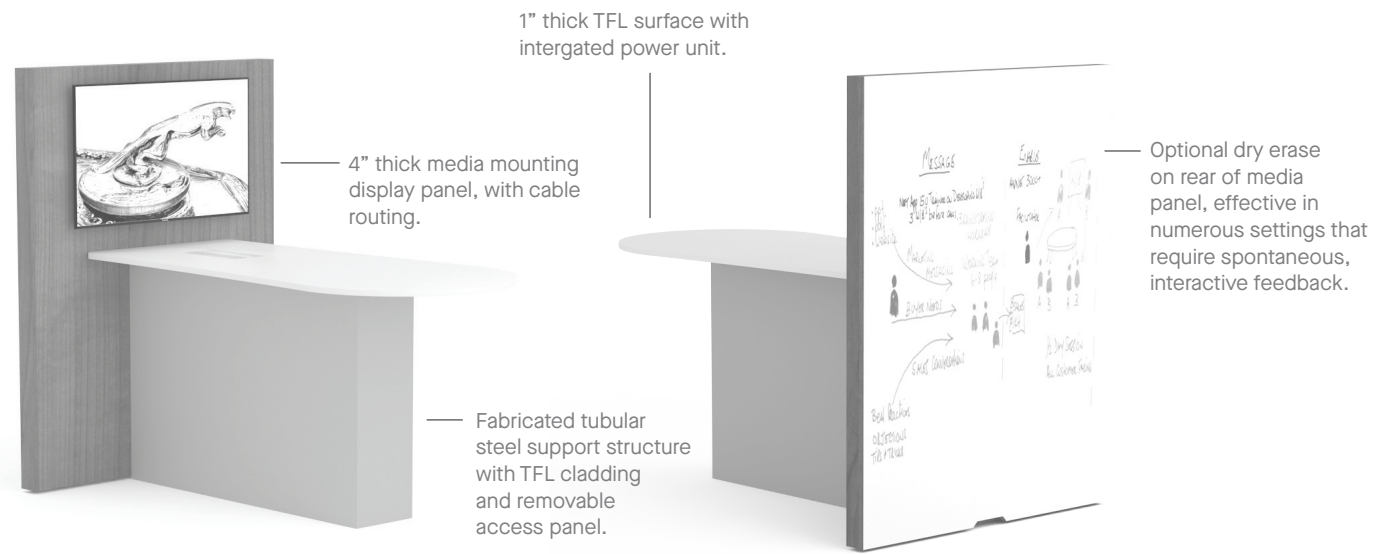

In-work surface power
Includes:
4x power
4x powered USB
4x HDMI*
ShowMe cables for transfer of laptop data to main display

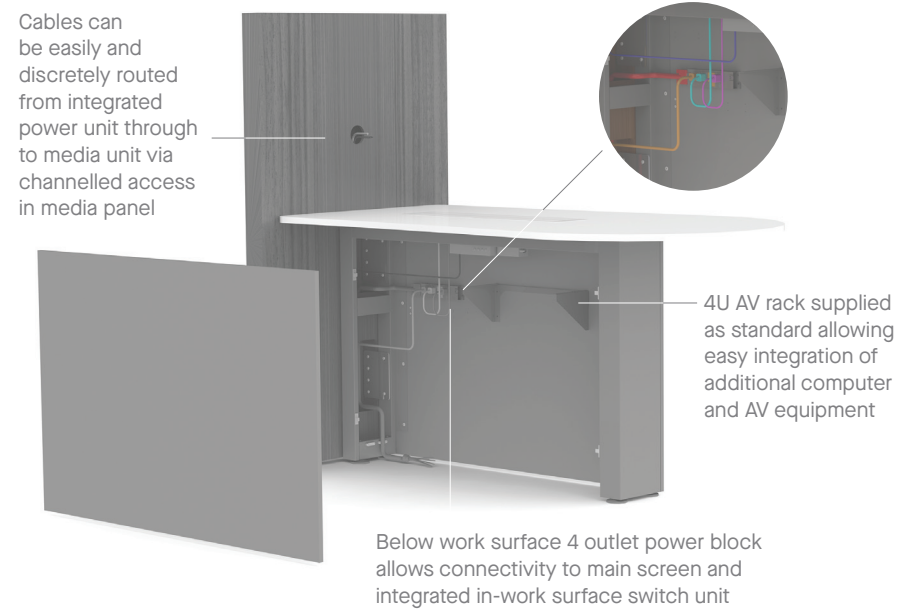

Access panel can be removed tool free via use of push fit clips

CHEMISTRY ANCILLARY TABLES

TECH TABLE



Grain Direction
Grain direction side to side on horizontal panels and top to bottom on vertical panels.

Storage Options
Lockable Tech Table perfectly designed for collaborative working. Available in:

3 compartment - 41"H x 30"D x 130"W
4 compartment - 41"H x 30"D x 165" W

Central units have no vertical divider which allows mass storage.

FEATURES



Ends of units are vented to allow computers to be stored within.







Top surface comes complete with 4 portholes for management of cables and the ability to accessorize with both monitor arms and in-desk power.



PRODUCT PRICING

CHEMISTRY MEETING TABLES – Goal Post Leg with No Power Cutout

		Width (inch)						
		36" W	50" W	60" W	66" W	72" W	78" W	
Meeting Table 50" Depth 		-	CHMT5050 1,883	CHMT6050 1,953	CHMT6650 2,094	CHMT7250 2,131	CHMT7850 2,171	Code
			SEE NOTE 1	SEE NOTE 1	SEE NOTE 1	SEE NOTE 1	SEE NOTE 1	TFL
Add On Meeting Table 50" Depth 		-	CHMT5050A 1,244	CHMT6050A 1,315	CHMT6650A 1,457	CHMT7250A 1,494	CHMT7850A 1,533	Code
			SEE NOTE 1	SEE NOTE 1	SEE NOTE 1	SEE NOTE 1	SEE NOTE 1	TFL
Meeting Table 62" Depth 		-	CHMT5062 1,975	CHMT6062 2,042	CHMT6662 2,189	CHMT7262 2,231	CHMT7862 2,276	Code
			SEE NOTE 1	SEE NOTE 1	SEE NOTE 1	SEE NOTE 1	SEE NOTE 1	TFL
Add On Meeting Table 62" Depth 		-	CHMT5062A 1,309	CHMT6062A 1,377	CHMT6622A 1,522	CHMT7262A 1,565	CHMT7862A 1,610	Code
			SEE NOTE 1	SEE NOTE 1	SEE NOTE 1	SEE NOTE 1	SEE NOTE 1	TFL
Mobile Meeting Table 36" depth x 29" high 		CHMT3636M 1,419	-	-	-	-	-	Code
								TFL

Note 1: Tables come with no power cut out. Click here to see tables with power cut outs.

All prices listed in USD \$
 Ships KD = Knock Down (Assembly Required)

PRODUCT PRICING

CHEMISTRY MEETING TABLES – 'O' Leg with No Power Cutout

		Width (inch)					
		50" W	60" W	66" W	72" W	78" W	
Meeting Table 50" Depth 		CHOMT5050 2,411	CHOMT6050 2,478	CHOMT6650 2,621	CHOMT7250 2,659	CHOMT7850 2,697	Code
		SEE NOTE 1	SEE NOTE 1	SEE NOTE 1	SEE NOTE 1	SEE NOTE 1	TFL
Add On Meeting Table 50" Depth 		CHMT5050A 1,244	CHMT6050A 1,315	CHMT6650A 1,457	CHMT7250A 1,494	CHMT7850A 1,533	Code
		SEE NOTE 1	SEE NOTE 1	SEE NOTE 1	SEE NOTE 1	SEE NOTE 1	TFL
Meeting Table 62" Depth 		CHOMT5062 2,476	CHOMT6062 2,542	CHOMT6662 2,687	CHOMT7262 2,732	CHOMT7862 2,777	Code
		SEE NOTE 1	SEE NOTE 1	SEE NOTE 1	SEE NOTE 1	SEE NOTE 1	TFL
Add On Meeting Table 62" Depth 		CHMT5062A 1,309	CHMT6062A 1,377	CHMT6662A 1,522	CHMT7262A 1,565	CHMT7862A 1,610	Code
		SEE NOTE 1	SEE NOTE 1	SEE NOTE 1	SEE NOTE 1	SEE NOTE 1	TFL
Tall Meeting Table 30" depth x 41" high 		-	CHTMT6030 1,923	CHTMT6630 1,976	CHTMT7230 2,018	CHTMT7830 2,054	Code
			SEE NOTE 1	SEE NOTE 1	SEE NOTE 1	SEE NOTE 1	TFL

Note 1: Tables come with no power cut out. Click here to see tables with power cut outs.

All prices listed in USD \$
 Ships KD = Knock Down (Assembly Required)

Finishes & Features Available...









TFL (1")	HD Highland Oak UM Urban Maple WH White WK Winter Oak SO Strata Oak CW Carini Walnut DN Denim LG Light Gray
Standard Top Features	Starter and Add on desks have scalloped cable access as standard Executive desks have a straight edge back edge as standard
Leg Colors	Silver White Black

To specify your desk...

1. Think through the configuration of Desk you require
2. Select the Codes of the individual items you need to achieve your configuration
3. Choose Finishes where appropriate: 'top' finishes / frame color / fabric color / acrylic color
4. Consider supporting product, screens, cable management and accessories

PRODUCT PRICING

CHEMISTRY MEETING TABLES – Goal Post Leg with Power Cutout

	Width (inch)					Code
	50" W	60" W	66" W	72" W	78" W	
Meeting Table with Oasis Cutout 50" Depth 	CHMT5050X 2,062	CHMT6050X 2,135	CHMT6650X 2,275	CHMT7250X 2,312	CHMT7850X 2,350	TFL
Add On Meeting Table with Oasis Cutout 50" Depth 	CHMT5050AX 1,425	CHMT6050AX 1,495	CHMT6650AX 1,637	CHMT7250AX 1,674	CHMT7850AX 1,713	TFL
Meeting Table with Oasis Cutout 62" Depth 	CHMT5062X 2,155	CHMT6062X 2,221	CHMT6662X 2,369	CHMT7262X 2,413	CHMT7862X 2,454	TFL
Add On Meeting Table with Oasis Cutout 62" Depth 	CHMT5062AX 1,488	CHMT6062AX 1,556	CHMT6662AX 1,704	CHMT7262AX 1,746	CHMT7862AX 1,790	TFL
Meeting Table with Cove Cutout 50" Depth 	CHMT5050Y 2,062	CHMT6050Y 2,135	CHMT6650Y 2,275	CHMT7250Y 2,312	CHMT7850Y 2,350	TFL
Add On Meeting Table with Cove Cutout 50" Depth 	CHMT5050AY 1,425	CHMT6050AY 1,495	CHMT6650AY 1,637	CHMT7250AY 1,674	CHMT7850AY 1,713	TFL
Meeting Table with Cove Cutout 62" Depth 	CHMT5062Y 2,155	CHMT6062Y 2,221	CHMT6662Y 2,369	CHMT7262Y 2,413	CHMT7862Y 2,454	TFL
Add On Meeting Table with Cove Cutout 62" Depth 	CHMT5062AY 1,488	CHMT6062AY 1,556	CHMT6662AY 1,704	CHMT7262AY 1,746	CHMT7862AY 1,790	TFL









All prices listed in USD \$
Ships KD = Knock Down (Assembly Required)

Finishes & Features Available...

TFL (1")	HD Highland Oak UM Urban Maple WH White WK Winter Oak SO Strata Oak CW Carini Walnut DN Denim LG Light Gray
Standard Top Features	Starter and Add on desks have scalloped cable access as standard Executive desks have a straight edge back edge as standard
Leg Colors	Silver White Black

PRODUCT PRICING

CHEMISTRY MEETING TABLES – 'O' Leg with Power Cutout

	Width (inch)					Code
	50" W	60" W	66" W	72" W	78" W	
Meeting Table with Oasis Cutout 50" Depth 	CHOMT5050X 2,589	CHOMT6050X 2,659	CHOMT6650X 2,800	CHOMT7250X 2,839	CHOMT7850X 2,877	TFL
Add On Meeting Table with Oasis Cutout 50" Depth 	CHMT5050AX 1,425	CHMT6050AX 1,495	CHMT6650AX 1,637	CHMT7250AX 1,674	CHMT7850AX 1,713	TFL
Meeting Table with Oasis Cutout 62" Depth 	CHOMT5062X 2,655	CHOMT6062X 2,715	CHOMT6662X 2,858	CHOMT7262X 2,911	CHOMT7862X 2,956	TFL
Add On Meeting Table with Oasis Cutout 62" Depth 	CHMT5062AX 1,488	CHMT6062AX 1,556	CHMT6662AX 1,704	CHMT7262AX 1,746	CHMT7862AX 1,790	TFL
Meeting Table with Cove Cutout 50" Depth 	CHOMT5050Y 2,589	CHOMT6050Y 2,659	CHOMT6650Y 2,800	CHOMT7250Y 2,839	CHOMT7850Y 2,877	TFL
Add On Meeting Table with Cove Cutout 50" Depth 	CHMT5050AY 1,425	CHMT6050AY 1,495	CHMT6650AY 1,637	CHMT7250AY 1,674	CHMT7850AY 1,713	TFL
Meeting Table with Cove Cutout 62" Depth 	CHOMT5062Y 2,655	CHOMT6062Y 2,715	CHOMT6662Y 2,868	CHOMT7262Y 2,911	CHOMT7862Y 2,956	TFL
Add On Meeting Table with Cove Cutout 62" Depth 	CHMT5062AY 1,488	CHMT6062AY 1,556	CHMT6662AY 1,704	CHMT7262AY 1,746	CHMT7862AY 1,790	TFL

All prices listed in USD \$
Ships KD = Knock Down (Assembly Required)

To specify your desk...

1. Think through the configuration of Desk you require
2. Select the Codes of the individual items you need to achieve your configuration
3. Choose Finishes where appropriate: 'top' finishes / frame color / fabric color / acrylic color
4. Consider supporting product, screens, cable management and accessories

CHEMISTRY MEETING TABLES – Desk Extensions / Storage Boxes

Desk Extension
16" Depth



Desk Extension
Storage Box
16" Depth
x 16" High



	Width (inch)		Code
	50"	62"	
Can be used on Goal Post Legs and 'O' Legs.	CHDE50 583	CHDE62 600	TFL
Can be used on Goal Post Legs and 'O' Legs.	CHDESB50 1,165	CHDESB62 1,199	TFL

CHEMISTRY MEETING TABLES – Cable Management

Double Cable Tray

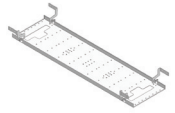

Double Cable Riser



Mid Leg Cable Riser

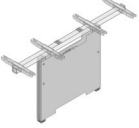

	Width (inch)					Code
	50" W	60" W	66" W	72" W	78" W	
SEE NOTE 1	CHDCT50 291	CHDCT60 327	CHDCT66 340	CHDCT72 351	CHDCT78 374	Price
SEE NOTE 1	SEE NOTE 1	SEE NOTE 1	SEE NOTE 1	SEE NOTE 1	SEE NOTE 1	
			CHCRD 320			Price
			SEE NOTE 1			
			CHLEGCM 378			Price
			SEE NOTE 2			

Note 1: Available in Black, White, and Silver.

Note 2: Only for use on the mid leg of "add on" meeting table sections.

All prices listed in USD \$

Ships KD = Knock Down (Assembly Required)

Finishes & Features Available...

TFL (1")	HD Highland Oak UM Urban Maple WH White WK Winter Oak SO Strata Oak CW Carini Walnut DN Denim LG Light Gray
Cable Management Colors	Silver White Black

CHEMISTRY MEETING TABLES – Power Modules

Stand Alone Oasis
Power Module

(4) Power, (3) Data
108" Power Cord
with 3 Prong Plug

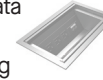

Stand Alone Cove
Power Module

(2) Power, (2) USB
Charging
108" Power Cord
with 3 Prong Plug



Daisy Chained Oasis
Power Module

(4) Power, (3) Data
Hardwired

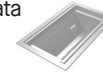

Daisy Chained Cove
Power Module

(2) Power, (2) USB
Charging
Hardwired



Hardwire, multi
circuit infeeds for
daisy chaining



Jumper cables for
daisy chaining



	Width (inch)							Code
	50"	60"	66"	72"	78"	108"	144"	
				72PWINF 138	-	108PWINF 175	144PWINF 214	Price
	50JUMP 129	60JUMP 141	66JUMP 147	72JUMP 154	78JUMP 159	-	-	Price

Note 1: Please specify desired finish color when ordering. (Black or Silver)

Note 2: Please specify desired finish color when ordering. (Black, White, or Silver)

Note 3: Cannot be daisy chained. Power Module comes standard with 108" power cord with 3 prong plug.

Note 4: Must be ordered with hardwire infeed and jumper cables to connect multiple power modules.

All prices listed in USD \$

Ships KD = Knock Down (Assembly Required)

To specify your desk...

1. Think through the configuration of Desk you require
2. Select the Codes of the individual items you need to achieve your configuration
3. Choose Finishes where appropriate: 'top' finishes / frame color / fabric color / acrylic color
4. Consider supporting product, screens, cable management and accessories

CHEMISTRY MEETING TABLES – AV Media Table / Tech Table

29"H x 39"D
AV Media Table

Dark gray frame
Black media
mounting display
Indesk power/AV



41"H x 39"D
AV Media Table

Dark gray frame
Black media
mounting display
Indesk power/AV



41"H x 48"D
Tech Table

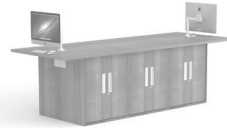

In Desk Power

1x Power
2x USB Charging



Width (inch)			
80.5" W		TG8045M	Code
		15,130	TFL
		15,264	TFL w/ Whiteboard
		SEE NOTE 1	
80.5" W		TG8045H	Code
		15,499	TFL
		15,632	TFL w/ Whiteboard
		SEE NOTE 1	
Width (inch)			
130" W	165" W		Code
TT13048-KD	TT16548-KD		TFL
6,775	8,419		
SEE NOTES 1 & 2	SEE NOTES 1 & 2		
		IDPTT	Code
		334	Price

Note 1: Ships knockdown and requires assembly.
Note 2: Please specify Silver, Black, or White pulls

All prices listed in USD \$
Ships KD = Knock Down (Assembly Required)

Large grid area for notes.

Finishes & Features Available...

TFL (1") HD Highland Oak | UM Urban Maple | WH White | WK Winter Oak | SO Strata Oak | CW Carini Walnut | DN Denim | LG Light Gray

FINISHES

CHEMISTRY FINISHES – Standard Top Finishes – TFL



Carini Walnut



Strata Oak



Urban Maple



Highland Oak



Winter Oak

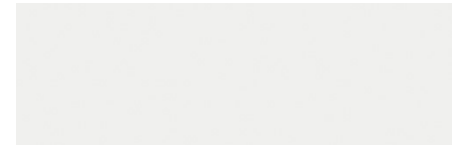

White

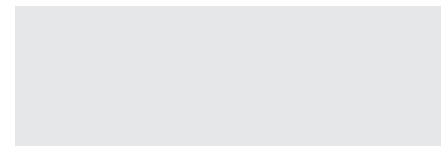

Light Gray



Denim

FRAME / LEG FINISHES



Black



White

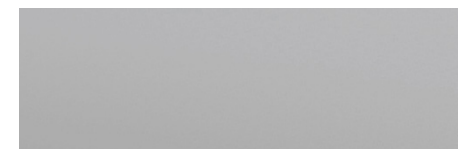

Silver

Color images above are for reference only. Please verify with actual color sample.