

**SENATOR**

**CHEMISTRY HEIGHT  
ADJUSTABLE**

# CHEMISTRY PLUS HEIGHT ADJUSTABLE

Chemistry incorporates a height adjustable workstation solution to respond to the needs of today's office, where simple elegance and inherent functionality are a must to meet a multitude of applications. Chemistry Plus Height Adjustable desks make individual requirements possible, allowing the option to vary posture and stand while working.

Designed to fully interact with the user, whether seated or standing, height adjustable desks permit the user to quickly set their optimum working height by means of a responsive push button electronic mechanism.

## CHEMISTRY PLUS HEIGHT ADJUSTABLE

### STANDARD FEATURES

- Height adjustable steel frame
- Leveling adjustment
- Scalloped cable access
- 1" TFL rectangular tops
- Electric operations
- Anti Collision Sensor

### SPECIFIABLE FEATURES

- Standalone or back to back

### COMPLEMENTARY OPTIONS

- Universal Screens
- Cable trays and risers
- Desk linking kits

### ACCESSORIES

- Monitor arms
- PU desk accessories
- Desk top accessories
- CPU holders
- Electrical accessories
- Screen accessories

### PERFORMANCE STANDARDS

- Designed to conform to and where applicable is tested to the following standards:
- BIFMA X5.5 x2014
- SCS-EC10.3-2014 v. 3.0 Indoor Advantage Gold

## DIMENSIONS

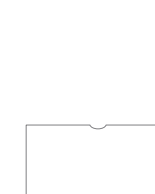
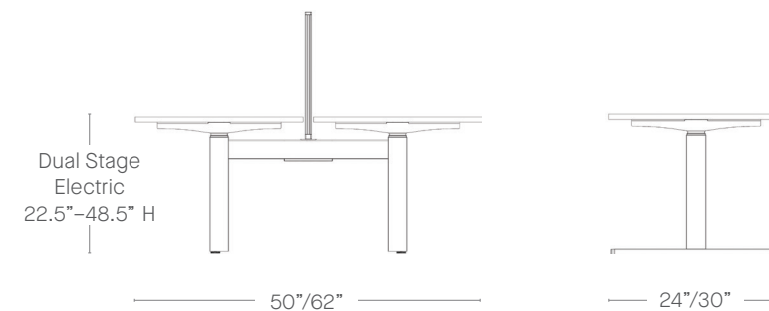

Single desk with I-leg  
Widths. 48"-78"  
Depths. 24" & 30"

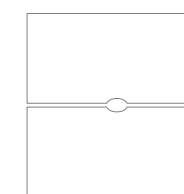

Back to back with H-leg  
Widths. 48"-78"  
Depths. 50" & 62"

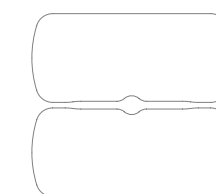

Pallet Top Back to back with H-leg  
Widths. 60"-78"  
Depths. 62"

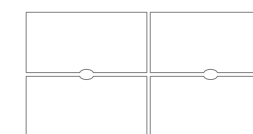

4 Person

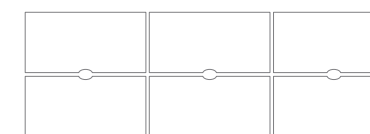

6 Person

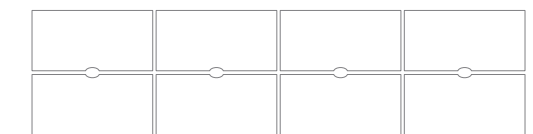

8 Person

CHEMISTRY PLUS HEIGHT ADJUSTABLE

1" Frame Height Adjustable

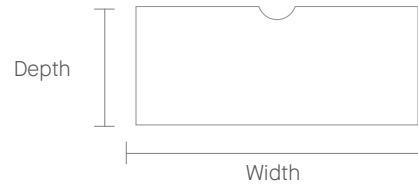

	48" W	54" W	60" W	66" W	72" W	78" W
24" D	●	●	●	●	●	●
30" D	●	●	●	●	●	●

Desk Mounted TFL Modesty Panels for Single Desks

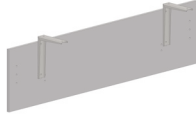

	48" W	54" W	60" W	66" W	72" W	78" W
14.5" H	●	●	●	●	●	●

Leg Mounted TFL Modesty Panels with Cable Tray for Single Desks

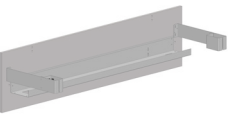

	48" W	54" W	60" W	66" W	72" W	78" W
14.5" H	●	●	●	●	●	●

Leg Mounted Cable Tray



	48" W	54" W	60" W	66" W	72" W	78" W
	●	●	●	●	●	●

CHEMISTRY PLUS HEIGHT ADJUSTABLE

Desktop Framed Screens for Single Desks

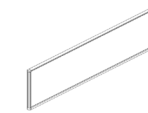

Desktop screen with Standard frame for single/inline height adjustable desk 16" high

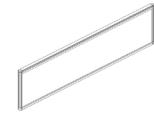

Desktop screen with single tool rail for single/inline height adjustable desk 16" high

	48" W	54" W	60" W	66" W	72" W	78" W
16" H	●	●	●	●	●	●

Desktop Frameless Screens for Single Desks

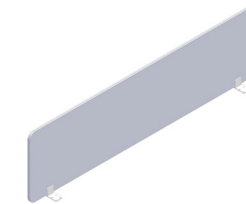

Desktop screen for single/inline height adjustable desk 16" high, complete with bracket

	48" W	54" W	60" W	66" W	72" W	78" W
16" H	●	●	●	●	●	●

Desk Mounted Screens for Single Desks

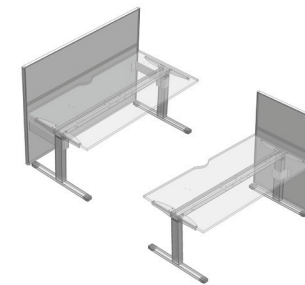

Desk Mounted Screen

	48" W	54" W	60" W	66" W	72" W	78" W
45" H	●	●	●	●	●	●

Desk End Screen

	24" W	30" W
45" H	●	●

CHEMISTRY PLUS HEIGHT ADJUSTABLE

'H' Frame Height Adjustable

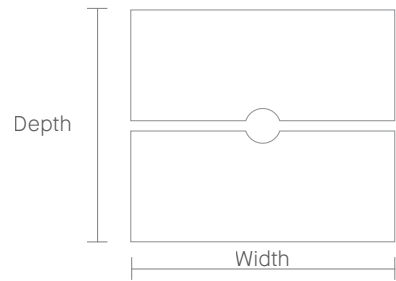

	48" W	54" W	60" W	66" W	72" W	78" W
50" D	●	●	●	●	●	●
62" D	●	●	●	●	●	●

Pallet Top Height Adjustable

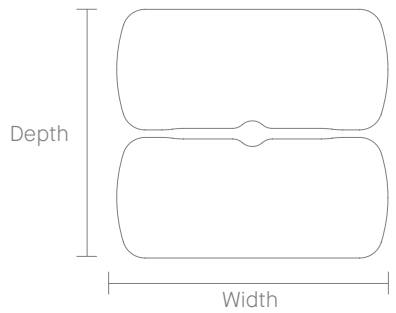

Frame is inset 3" from each end of the work surface.

	60" W	72" W	78" W
62" D	●	●	●

Executive Desk

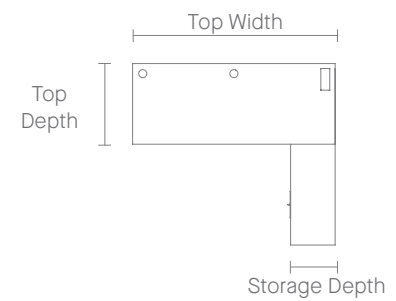

Top Depth 30"

	72" W	78" W
18" D Storage	●	●
24" D Storage	●	●

Desktop Framed Screens for Back to Back Benches



Desktop screen with Standard frame for back to back height adjustable bench, 26" high, 45" from top to floor, complete with bracket

Desktop screen with single tool rail for back to back height adjustable bench, 26" high, 45" from top to floor, complete with bracket

	48" W	54" W	60" W	66" W	72" W	78" W
26" H	●	●	●	●	●	●

CHEMISTRY PLUS HEIGHT ADJUSTABLE

Desktop Frameless Screens for Back to Back Benches



Desktop screen for back to back height adjustable bench, 26" high, 45" from top to floor, complete with bracket.

	48" W	54" W	60" W	66" W	72" W	78" W
26" H	●	●	●	●	●	●

Glass Screens for Back to Back Benches



Desktop screen for back to back height adjustable bench, 26" high, 45" from top to floor. Rails specified separately.

	48" W	54" W	60" W	66" W	72" W	78" W
26" H	●	●	●	●	●	●

Cable Trays for 'I' and 'H' Frames

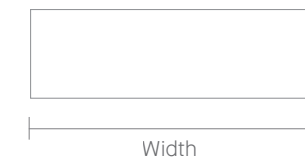

	48" W	54" W	60" W	66" W	72" W	78" W
	●	●	●	●	●	●

Cable Risers and Fixtures

Vertical cable riser for single desks.

Vertical cable riser for back to back benches.

Vertical cable chain

Screen attachment bracket pack comprising of two brackets

Desk linking kit comprising of two brackets

CHEMISTRY PLUS HEIGHT ADJUSTABLE

**3 H** Blue  
**3 G** Green/Yellow  
**1-2-4 G** Green  
**3 N** Gray  
**1-2-4 N** White  
**1 H** Black  
**2 H** Red  
**4 H** Pink

**3 IG** **2** **1** **4**

**SINGLE DESK**

**Upper Cable Tray**  
Cable trays are available to manage power options.

**Cable Riser**  
An optional cable riser is available to manage power from the floor to the upper or lower cable tray.

**Leg Mounted Modesty with Cable Tray**  
Cable trays are available to manage power options.

**Single Desk Frame**  
A powder coated welded framework with height adjustable columns.

**BACK TO BACK BENCH**

**Upper Cable Tray**  
Cable trays are available to manage power options.

**Cable Trough**  
Included with all back to back benches. Fixed to the underside of the frame to manage power.

**Cable Chain**  
An optional cable chain is available to manage power from the lower cable trough to the upper cable tray.

**Cable Riser**  
Used when power is fed from the floor to the cable trough. The cable riser is bolted to the underside of the trough.

**Bench Frame**  
A powder coated welded framework with height adjustable columns.

WORK SURFACES

On single desks, one top is supplied per starter or add on desk.  
 On back to back benches, two tops are supplied per bench.

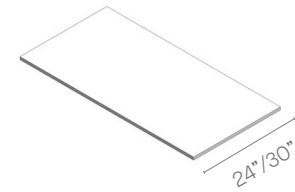

Chemistry Plus tops are available with 24" or 30" depths and lengths of 48", 54", 60", 66", 72", and 78".  
 Tops are available in TFL with a scallop in the back for cable access.  
 TFL tops have a 2mm laser edge band all around.



FRAMEWORK

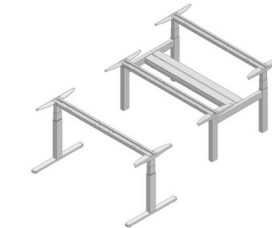

**Electric Desk Frame**  
Dual Stage Electric desks have a height adjustment of 22.5" - 48.5"

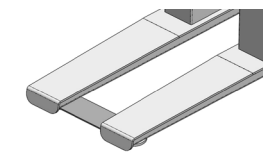

**Desk Linking Kits**  
Linking kits are available to align height adjustable workstations in a straight row.  
 The kits create and hold a 1" gap between workstations, eliminating potential pinch points. Kits are available for both inline desks, and back to back benches.



**Electric Chemistry Executive Desk Frame**  
The electric desk has a working range of 29" - 48.5" high.  
 This can be adjusted electronically via a desk switch.  
 The height adjustable single legs have a larger foot surface to add stability to the desk.

CABLE MANAGEMENT



Optional cable trays are available that hang underneath the desktop. These allow for power blocks to be laid inside and cables fixed in place. This improves safety and keeps the under desk space tidy.

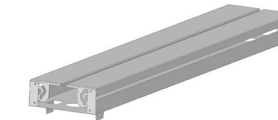

The cable trough is mounted between the lower frame on back to back benches. The trough is the entry point for power and data into the bench and provides an enclosure for power blocks and wires. Slide on covers conceal power and wiring.

\*Not available for single height adjustable desking

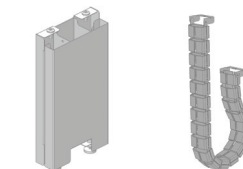

An optional vertical cable manager is available to allow power and data to be taken from the floor to the cable trough. The riser attaches to the end of the cable trough to ensure a tidy transfer of cables. Optional flexible plastic cable chains are available to provide a secure way to manage power and data cabling from the trough up to the cable tray.

SCREENS

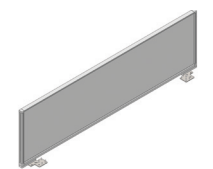

Screens are available to divide up benches and hang accessories. The screens are fixed to the height adjustable bench frame or fixed to the underside of the worksurface on the single desks with metal brackets. Fabric, TFL, Acrylic, and Glass screen options are available.

CHEMISTRY EXECUTIVE DESKING - STORAGE



18" deep storage unit comes complete with 1x personal drawer, 1x filing drawer, open storage with shelves, a cubby for a PC with port hole access and integrated vertical cable management system.



24" deep storage unit comes complete with 1x personal drawer, 1x filing drawer, open storage with shelves, a cubby for a PC with port hole access and integrated vertical cable management system.

Filing drawer comes complete with filing cradle to support letter filing.



CHEMISTRY PLUS HEIGHT ADJUSTABLE

TYPICAL "I"-LEG DESK WIRING LAYOUT.

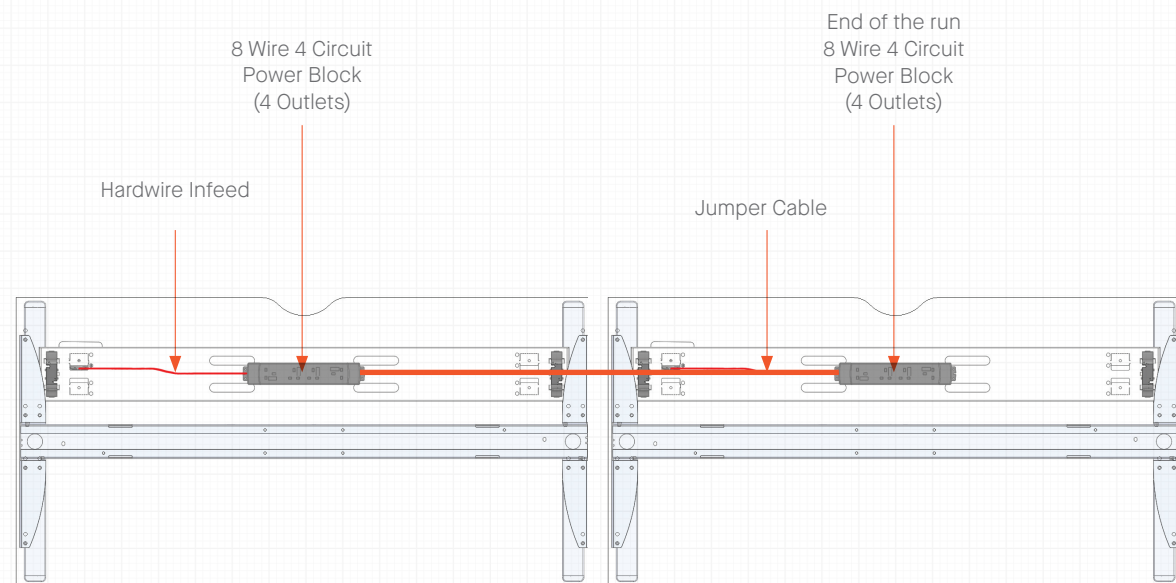
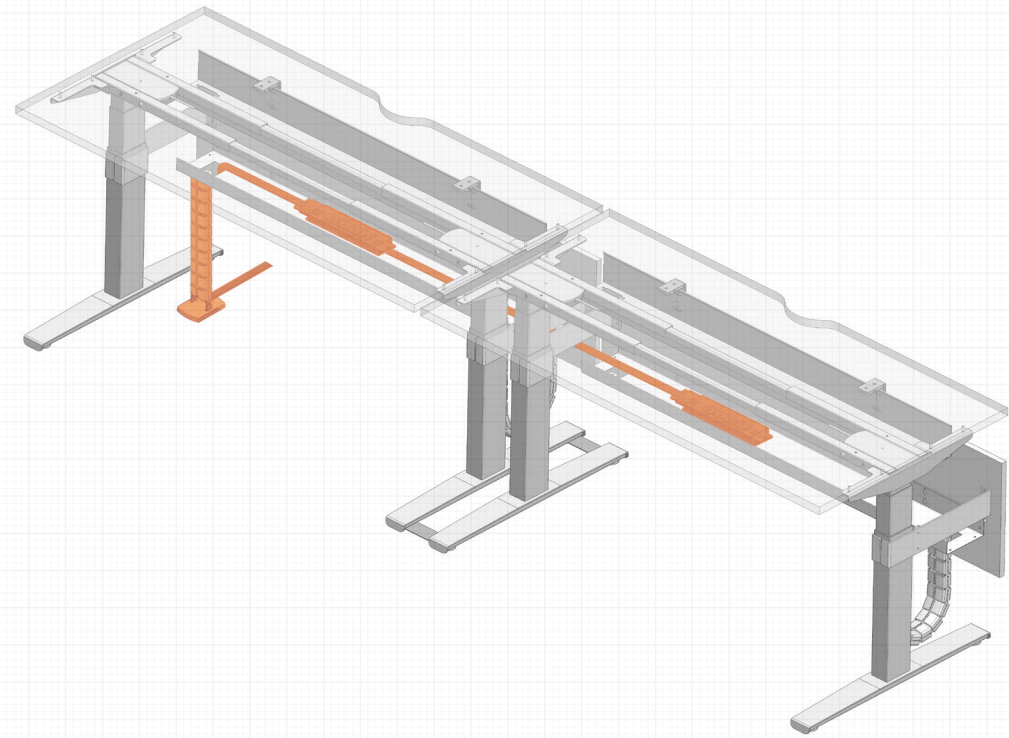

CHEMISTRY PLUS HEIGHT ADJUSTABLE

TYPICAL "H"-LEG DESK WIRING LAYOUT.

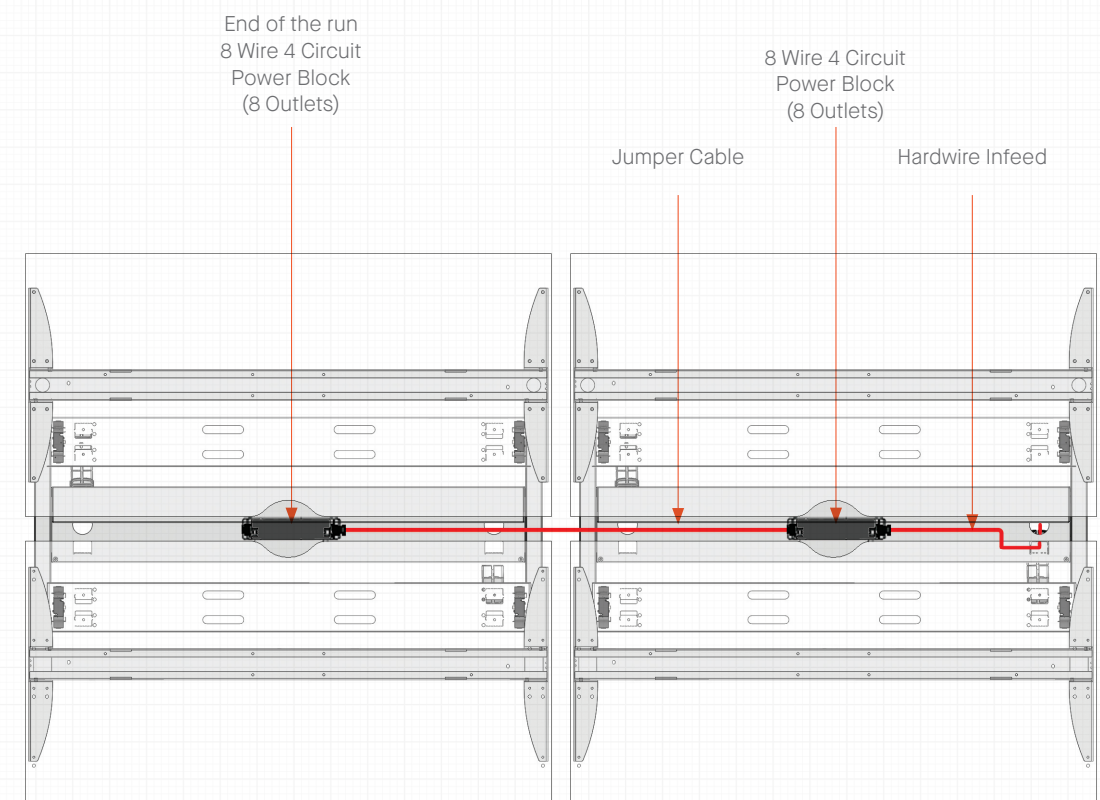
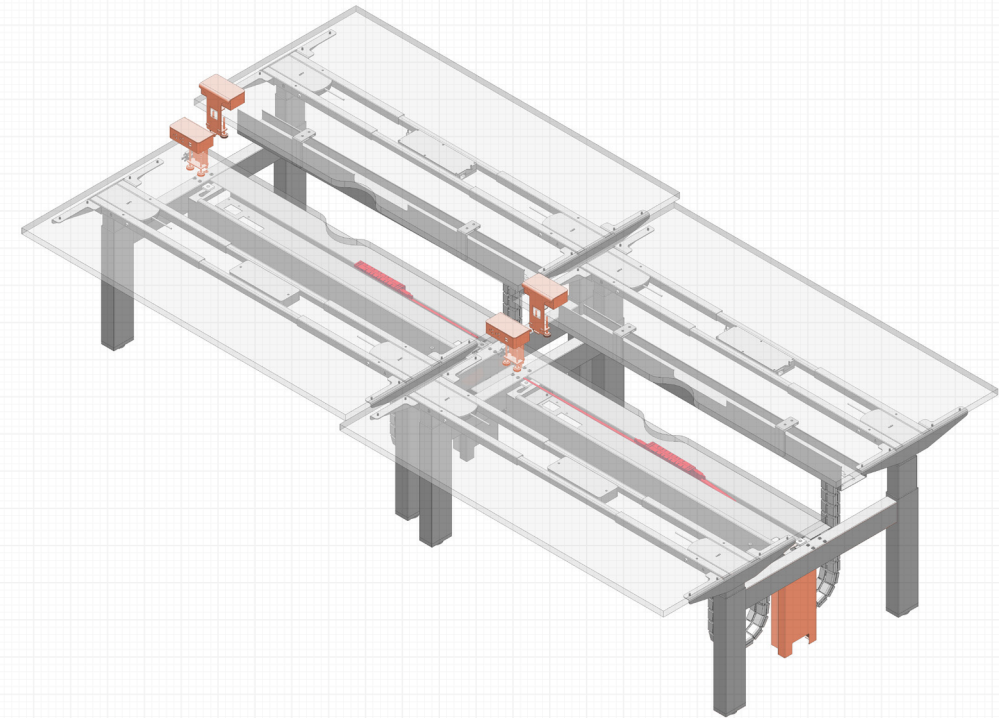

PRODUCT PRICING

CHEMISTRY PLUS HEIGHT ADJUSTABLE – Single Desk

		Width (inch)						
		48" W	54" W	60" W	66" W	72" W	78" W	
<p>Single HA Dual Stage 24" Depth</p>	Height adjustable between 22.5" - 48.5"	<b>CHPDSAE4824</b> 1,654	<b>CHPDSAE5424</b> 1,666	<b>CHPDSAE6024</b> 1,677	<b>CHPDSAE6624</b> 1,691	<b>CHPDSAE7224</b> 1,699	<b>CHPDSAE7824</b> 1,711	Code TFL
		SEE NOTE 2	SEE NOTE 2	SEE NOTE 2	SEE NOTE 2	SEE NOTE 2	SEE NOTE 2	
<p>Single HA Dual Stage 30" Depth</p>	Height adjustable between 22.5" - 48.5"	<b>CHPDSAE4830</b> 1,694	<b>CHPDSAE5430</b> 1,707	<b>CHPDSAE6030</b> 1,722	<b>CHPDSAE6630</b> 1,737	<b>CHPDSAE7230</b> 1,749	<b>CHPDSAE7830</b> 1,763	Code TFL
		SEE NOTE 2	SEE NOTE 2	SEE NOTE 2	SEE NOTE 2	SEE NOTE 2	SEE NOTE 2	
<p>Surface Mounted Modesty Panel</p>	Mounts to the underside of the worksurface	<b>CHPAMW48</b> 343	<b>CHPAMW54</b> 353	<b>CHPAMW60</b> 363	<b>CHPAMW66</b> 375	<b>CHPAMW72</b> 388	<b>CHPAMW78</b> 397	Code TFL
		SEE NOTE 1	SEE NOTE 1	SEE NOTE 1	SEE NOTE 1	SEE NOTE 1	SEE NOTE 1	
<p>Desk Mounted Cable Tray</p>	One required per desktop	<b>CHPDSACT48</b> 155	<b>CHPDSACT54</b> 164	<b>CHPDSACT60</b> 177	<b>CHPDSACT66</b> 189	<b>CHPDSACT72</b> 220	<b>CHPDSACT78</b> 239	Code Price
		SEE NOTE 2	SEE NOTE 2	SEE NOTE 2	SEE NOTE 2	SEE NOTE 2	SEE NOTE 2	
<p>Vertical Cable Riser</p>	Carries cables from floor to Cable Tray or directly to the work surface	<b>FBAVCM</b> 148						Code Price
		SEE NOTE 2						
<p>Vertical Cable Chain</p>	Carries cables from the Leg Mounted Cable Tray to the Desk Mounted Cable Tray	<b>FBABVCM</b> 148						Code Price
		SEE NOTE 2						
<p>CPU Holder HA Desk</p>	Mounts to underside of desk to hold computer tower	<b>CHPMUSCPUH</b> 306						Code Price
		SEE NOTE 2						
<p>Inline Desk Linking Kit</p>	Connects two single desk frames to create a 1" gap between work surfaces for safety	<b>CHPUSAEDLNK</b> 175						Code Price
		SEE NOTE 2						

Note 1: Available in all TFL finishes

Note 2: Specify black, white, or silver metalwork.

All prices listed in USD \$

Ships KD = Knock Down (Assembly Required)

Finishes & Features Available...

TFL (1")	HD Highland Oak   UM Urban Maple   WH White   AT Autumn   WK Winter Oak   SO Strata Oak   CW Carini Walnut   DN Denim   LY Clay   LG Light Gray
Standard Top Features	Starter and Add on desks have scalloped cable access as standard   Executive desks have a straight edge back edge as standard
Leg Colors	Silver   White   Black

PRODUCT PRICING

CHEMISTRY PLUS HEIGHT ADJUSTABLE – Cable Management

		Width (inch)						
		48" W	54" W	60" W	66" W	72" W	78" W	
<p>Stationary Leg Mounted Cable Tray 24" Depth</p>		<b>CHP24LMSCT48</b> 490	<b>CHP24LMSCT54</b> 498	<b>CHP24LMSCT60</b> 511	<b>CHP24LMSCT66</b> 524	<b>CHP24LMSCT72</b> 557	<b>CHP24LMSCT78</b> 574	Code Price
		SEE NOTE 2	SEE NOTE 2	SEE NOTE 2	SEE NOTE 2	SEE NOTE 2	SEE NOTE 2	
<p>Stationary Leg Mounted Modesty Panel with Cable Tray 24" Depth</p>		<b>CHP24LMAMW48</b> 597	<b>CHP24LMAMW54</b> 606	<b>CHP24LMAMW60</b> 616	<b>CHP24LMAMW66</b> 629	<b>CHP24LMAMW72</b> 641	<b>CHP24LMAMW78</b> 651	Code Price
		SEE NOTES 1 & 2	SEE NOTES 1 & 2	SEE NOTES 1 & 2	SEE NOTES 1 & 2	SEE NOTES 1 & 2	SEE NOTES 1 & 2	
<p>Stationary Leg Mounted Cable Tray 30" Depth</p>		<b>CHP30LMSCT48</b> 503	<b>CHP30LMSCT54</b> 512	<b>CHP30LMSCT60</b> 523	<b>CHP30LMSCT66</b> 537	<b>CHP30LMSCT72</b> 569	<b>CHP30LMSCT78</b> 586	Code Price
		SEE NOTE 2	SEE NOTE 2	SEE NOTE 2	SEE NOTE 2	SEE NOTE 2	SEE NOTE 2	
<p>Stationary Leg Mounted Modesty Panel with Cable Tray 30" Depth</p>		<b>CHP30LMAMW48</b> 609	<b>CHP30LMAMW54</b> 620	<b>CHP30LMAMW60</b> 630	<b>CHP30LMAMW66</b> 641	<b>CHP30LMAMW72</b> 654	<b>CHP30LMAMW78</b> 664	Code Price
		SEE NOTES 1 & 2	SEE NOTES 1 & 2	SEE NOTES 1 & 2	SEE NOTES 1 & 2	SEE NOTES 1 & 2	SEE NOTES 1 & 2	

Note 1: Panel available in all TFL finishes

Note 2: Frame available in Black, White, and Silver

All prices listed in USD \$

Ships KD = Knock Down (Assembly Required)

To specify your desk...

1. Think through the configuration of Desk you require
2. Select the Codes of the individual items you need to achieve your configuration
3. Choose Finishes where appropriate: 'top' finishes / frame color / fabric color / acrylic color
4. Consider supporting product, screens, cable management and accessories

## CHEMISTRY PLUS HEIGHT ADJUSTABLE – Single Desk Screens

Desktop Screen w/  
Standard Frame Single/  
Inline HA Desk

16" High



Width (inch)						
48" W	54" W	60" W	66" W	72" W	78" W	
<b>US1648</b>	<b>US1654</b>	<b>US1660</b>	<b>US1666</b>	<b>US1672</b>	<b>US1678</b>	Code
428	447	464	506	520	541	TFL
626	666	693	709	742	777	Acrylic
499	524	554	574	591	616	Grade A
541	566	603	626	649	675	Grade B
639	674	723	761	791	824	Grade C
SEE NOTES 1 & 2	SEE NOTES 1 & 2	SEE NOTES 1 & 2	SEE NOTES 1 & 2	SEE NOTES 1 & 2	SEE NOTES 1 & 2	

Desktop Screen w/  
Single Tool Rail for  
Single/Inline HA Desk

16" High



<b>UST1648</b>	<b>UST1654</b>	<b>UST1660</b>	<b>UST1666</b>	<b>UST1672</b>	<b>UST1678</b>	Code
443	461	479	518	533	554	TFL
639	680	707	723	755	791	Acrylic
514	539	566	586	605	630	Grade A
554	581	615	639	662	689	Grade B
653	687	738	775	806	839	Grade C
SEE NOTES 1 & 2	SEE NOTES 1 & 2	SEE NOTES 1 & 2	SEE NOTES 1 & 2	SEE NOTES 1 & 2	SEE NOTES 1 & 2	

Screen Fixing Bracket Back

Comprising of two brackets

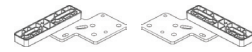

<b>CHFBKT1</b>						Code
100						Price
SEE NOTES 1 & 3						

Desktop Screen  
Frameless Non-Pinnable

16" High  
Supplied with  
Fixing Brackets



<b>CHPSF1648</b>	<b>CHPSF1654</b>	<b>CHPSF1660</b>	<b>CHPSF1666</b>	<b>CHPSF1672</b>	<b>CHPSF1678</b>	Code
472	482	497	510	527	537	Grade A
510	522	545	560	581	596	Grade B
605	626	660	682	718	739	Grade C
SEE NOTE 1	SEE NOTE 1	SEE NOTE 1	SEE NOTE 1	SEE NOTE 1	SEE NOTE 1	

Desktop Screen  
Frameless Pinnable

16" High  
Supplied with  
Fixing Brackets



<b>CHPSF1648P</b>	<b>CHPSF1654P</b>	<b>CHPSF1660P</b>	<b>CHPSF1666P</b>	<b>CHPSF1672P</b>	<b>CHPSF1678P</b>	Code
564	609	641	667	700	726	Grade A
602	650	685	717	755	784	Grade B
697	752	803	839	891	928	Grade C
SEE NOTE 1	SEE NOTE 1	SEE NOTE 1	SEE NOTE 1	SEE NOTE 1	SEE NOTE 1	

Note 1: Specify black, white, or silver metalwork.

All prices listed in USD \$

Note 2: Must be ordered with CHFBKT1 bracket for single desks. Fixes to desk top.

Ships KD = Knock Down (Assembly Required)

Note 3: To be used on single desks with framed desktop screens.

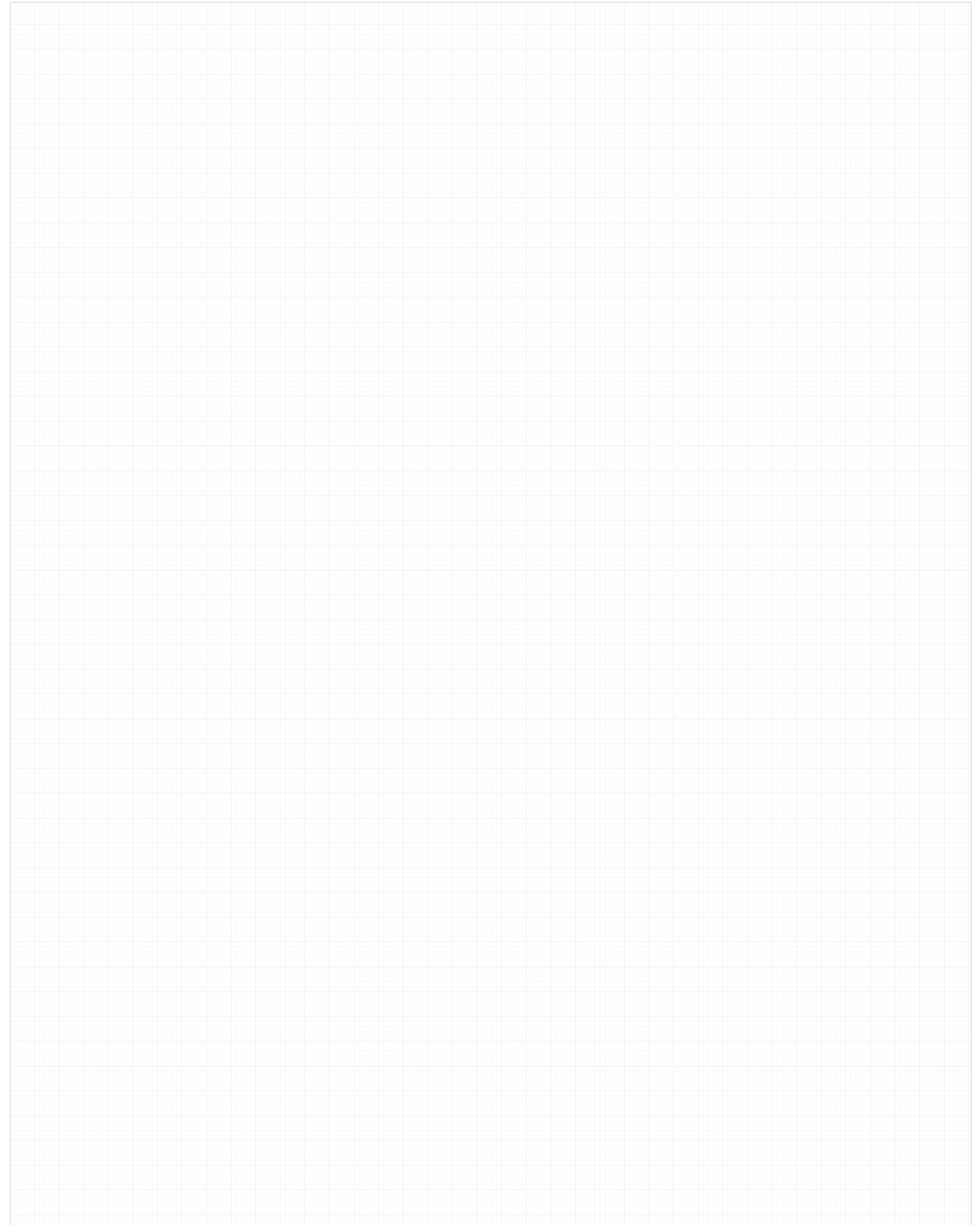



## Finishes & Features Available...

TFL (1")	HD Highland Oak   UM Urban Maple   WH White   AT Autumn   WK Winter Oak   SO Strata Oak   CW Carini Walnut   DN Denim   LY Clay   LG Light Gray
Frame Colors	Silver   White   Black
Fabrics	Grade A Camira Era   Grade B Camira Lucia, Camira Nexus   Grade C Camira Blazer, Camira Blazer Lite, Camira Aquarius, Camira Main Line Flax, Camira Synergy, Camira Synergy 66
Acrylic Colors	Clear   Opaque Crystal   Opaque White   Opaque Green   Opaque Blue



PRODUCT PRICING

CHEMISTRY PLUS HEIGHT ADJUSTABLE DESK – Desk Mounted Screens 24” D Desks

		Width (inch)							
		48" W	54" W	60" W	66" W	72" W	78" W		
<b>24" D Desk Mounted HA Single Desk Screen w/ Standard Frame and Cable Tray</b> 45" High 		<b>CHP24SC4548</b>	<b>CHP24SC4554</b>	<b>CHP24SC4560</b>	<b>CHP24SC4566</b>	<b>CHP24SC4572</b>	<b>CHP24SC4578</b>	Code	
		1,322	1,344	1,384	1,418	1,450	1,487	TFL	
		1,480	1,533	1,582	1,652	1,696	1,827	Grade A	
		1,589	1,660	1,719	1,805	1,859	2,007	Grade B	
		1,867	1,982	2,058	2,188	2,263	2,456	Grade C	
	SEE NOTE 1	SEE NOTE 1	SEE NOTE 1	SEE NOTE 1	SEE NOTE 1	SEE NOTE 1	SEE NOTE 1		
<b>24" D Desk Mounted HA Single Desk Screen w/ Tool Rail and Cable Tray</b> 45" High 		<b>CHP24STC4548</b>	<b>CHP24STC4554</b>	<b>CHP24STC4560</b>	<b>CHP24STC4566</b>	<b>CHP24STC4572</b>	<b>CHP24STC4578</b>	Code	
		1,334	1,357	1,398	1,430	1,463	1,501	TFL	
		1,493	1,559	1,594	1,663	1,709	1,842	Grade A	
		1,604	1,674	1,730	1,817	1,872	2,020	Grade B	
		1,881	1,995	2,045	2,202	2,278	2,468	Grade C	
	SEE NOTE 1	SEE NOTE 1	SEE NOTE 1	SEE NOTE 1	SEE NOTE 1	SEE NOTE 1	SEE NOTE 1		
<b>24" D Desk Mounted HA Single Desk Screen w/ Standard Frame</b> 45" High 		<b>CHP24S4548</b>	<b>CHP24S4554</b>	<b>CHP24S4560</b>	<b>CHP24S4566</b>	<b>CHP24S4572</b>	<b>CHP24S4578</b>	Code	
		1,169	1,190	1,231	1,264	1,297	1,334	TFL	
		1,326	1,379	1,428	1,497	1,543	1,675	Grade A	
		1,437	1,508	1,564	1,652	1,706	1,853	Grade B	
		1,714	1,827	1,906	2,036	2,111	2,301	Grade C	
	SEE NOTE 1	SEE NOTE 1	SEE NOTE 1	SEE NOTE 1	SEE NOTE 1	SEE NOTE 1	SEE NOTE 1		
<b>24" D Desk Mounted HA Single Desk Screen w/ Tool Rail</b> 45" High 		<b>CHP24ST4548</b>	<b>CHP24ST4554</b>	<b>CHP24ST4560</b>	<b>CHP24ST4566</b>	<b>CHP24ST4572</b>	<b>CHP24ST4578</b>	Code	
		1,182	1,205	1,244	1,279	1,310	1,348	TFL	
		1,341	1,394	1,442	1,512	1,556	1,689	Grade A	
		1,450	1,521	1,579	1,663	1,720	1,867	Grade B	
		1,726	1,843	1,918	2,049	2,123	2,315	Grade C	
	SEE NOTE 1	SEE NOTE 1	SEE NOTE 1	SEE NOTE 1	SEE NOTE 1	SEE NOTE 1	SEE NOTE 1		
<b>24" D Desk Mounted HA Single Desk End Screen w/ Standard Frame</b> 45" High 		<b>CHPDE4524</b>						Code	
		947						TFL	
		1,045						Grade A	
		1,108						Grade B	
		1,282						Grade C	
		SEE NOTE 1							
<b>24" D Desk Mounted HA Single Desk End Screen w/ Tool Rail</b> 45" High 		<b>CHPDET4524</b>						Code	
		960						TFL	
		1,056						Grade A	
		1,121						Grade B	
		1,294						Grade C	
		SEE NOTE 1							
<b>4 Way Linking Post with Adjustable Foot</b> 45" High 		<b>US4WPST45</b>						Code	
		154						Price	
		SEE NOTE 1							

Note 1: Specify black, white, or silver metalwork.

All prices listed in USD \$

Ships KD = Knock Down (Assembly Required)

Finishes & Features Available...

TFL (1")	HD Highland Oak   UM Urban Maple   WH White   AT Autumn   WK Winter Oak   SO Strata Oak   CW Carini Walnut   DN Denim   LY Clay   LG Light Gray
Frame Colors	Silver   White   Black
Fabrics	Grade A Camira Era   Grade B Camira Lucia, Camira Nexus   Grade C Camira Blazer, Camira Blazer Lite, Camira Aquarius, Camira Main Line Flax, Camira Synergy, Camira Synergy 66

PRODUCT PRICING

CHEMISTRY PLUS HEIGHT ADJUSTABLE DESK – Desk Mounted Screens 30” D Desks

		Width (inch)							
		48" W	54" W	60" W	66" W	72" W	78" W		
<b>30" D Desk Mounted HA Single Desk Screen w/ Standard Frame and Cable Tray</b> 45" High 		<b>CHP30SC4548</b>	<b>CHP30SC4554</b>	<b>CHP30SC4560</b>	<b>CHP30SC4566</b>	<b>CHP30SC4572</b>	<b>CHP30SC4578</b>	Code	
		1,334	1,357	1,398	1,430	1,463	1,501	TFL	
		1,493	1,559	1,594	1,663	1,709	1,842	Grade A	
		1,604	1,674	1,730	1,817	1,872	2,020	Grade B	
		1,881	1,995	2,045	2,202	2,278	2,468	Grade C	
	SEE NOTE 1	SEE NOTE 1	SEE NOTE 1	SEE NOTE 1	SEE NOTE 1	SEE NOTE 1	SEE NOTE 1		
<b>30" D Desk Mounted HA Single Desk Screen w/ Tool Rail and Cable Tray</b> 45" High 		<b>CHP30STC4548</b>	<b>CHP30STC4554</b>	<b>CHP30STC4560</b>	<b>CHP30STC4566</b>	<b>CHP30STC4572</b>	<b>CHP30STC4578</b>	Code	
		1,348	1,372	1,412	1,445	1,477	1,514	TFL	
		1,506	1,573	1,609	1,678	1,723	1,855	Grade A	
		1,616	1,687	1,745	1,830	1,885	2,034	Grade B	
		1,893	2,008	2,058	2,214	2,290	2,482	Grade C	
	SEE NOTE 1	SEE NOTE 1	SEE NOTE 1	SEE NOTE 1	SEE NOTE 1	SEE NOTE 1	SEE NOTE 1		
<b>30" D Desk Mounted HA Single Desk Screen w/ Standard Frame</b> 45" High 		<b>CHP30S4548</b>	<b>CHP30S4554</b>	<b>CHP30S4560</b>	<b>CHP30S4566</b>	<b>CHP30S4572</b>	<b>CHP30S4578</b>	Code	
		1,182	1,205	1,244	1,279	1,310	1,348	TFL	
		1,341	1,394	1,443	1,512	1,556	1,689	Grade A	
		1,450	1,521	1,578	1,663	1,720	1,867	Grade B	
		1,726	1,843	1,918	2,049	2,123	2,315	Grade C	
	SEE NOTE 1	SEE NOTE 1	SEE NOTE 1	SEE NOTE 1	SEE NOTE 1	SEE NOTE 1	SEE NOTE 1		
<b>30" D Desk Mounted HA Single Desk Screen w/ Tool Rail</b> 45" High 		<b>CHP30ST4548</b>	<b>CHP30ST4554</b>	<b>CHP30ST4560</b>	<b>CHP30ST4566</b>	<b>CHP30ST4572</b>	<b>CHP30ST4578</b>	Code	
		1,193	1,217	1,258	1,291	1,324	1,360	TFL	
		1,352	1,407	1,457	1,523	1,570	1,703	Grade A	
		1,462	1,535	1,592	1,677	1,641	1,881	Grade B	
		1,740	1,853	1,932	2,060	2,138	2,327	Grade C	
	SEE NOTE 1	SEE NOTE 1	SEE NOTE 1	SEE NOTE 1	SEE NOTE 1	SEE NOTE 1	SEE NOTE 1		
<b>30" D Desk Mounted HA Single Desk End Screen w/ Standard Frame</b> 45" High 		<b>CHPDE4530</b>						Code	
		980						TFL	
		1,096						Grade A	
		1,172						Grade B	
		1,358						Grade C	
		SEE NOTE 1							
<b>30" D Desk Mounted HA Single Desk End Screen w/ Tool Rail</b> 45" High 		<b>CHPDET4530</b>						Code	
		994						TFL	
		1,110						Grade A	
		1,186						Grade B	
		1,373						Grade C	
		SEE NOTE 1							
<b>4 Way Linking Post with Adjustable Foot</b> 45" High 		<b>US4WPST45</b>						Code	
		154						Price	
		SEE NOTE 1							

All prices listed in USD \$

Ships KD = Knock Down (Assembly Required)

To specify your desk...

1. Think through the configuration of Desk you require
2. Select the Codes of the individual items you need to achieve your configuration
3. Choose Finishes where appropriate: \*top\* finishes / frame color / fabric color / acrylic color
4. Consider supporting product, screens, cable management and accessories

**CHEMISTRY PLUS SINGLE HEIGHT ADJUSTABLE DESK – Screen Attachment**

60" x 30" workstations

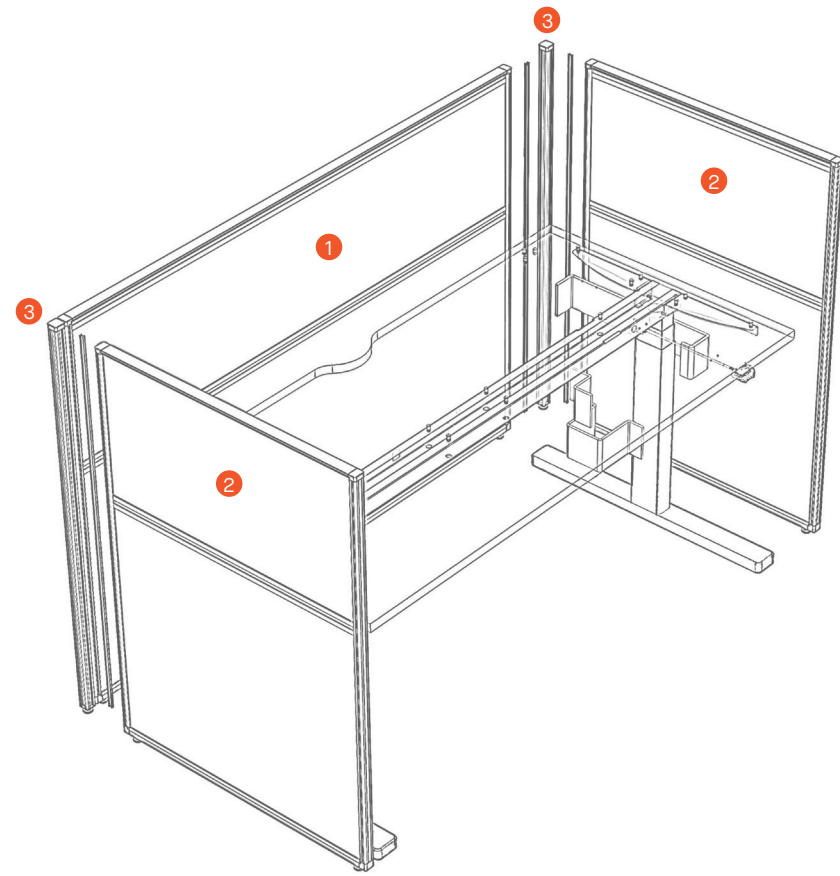

	Code	Description	QTY
1	CHP30ST4560	Desk Mounted HA Desk Screen	1
2	CHPDET4530	Desk Mounted HA Single Desk End Screen	2
3	US4WPST45	4-Way Linking Post Supplied with adjustable foot	2

**CHEMISTRY PLUS BACK TO BACK HEIGHT ADJUSTABLE BENCH – Screen Attachment**

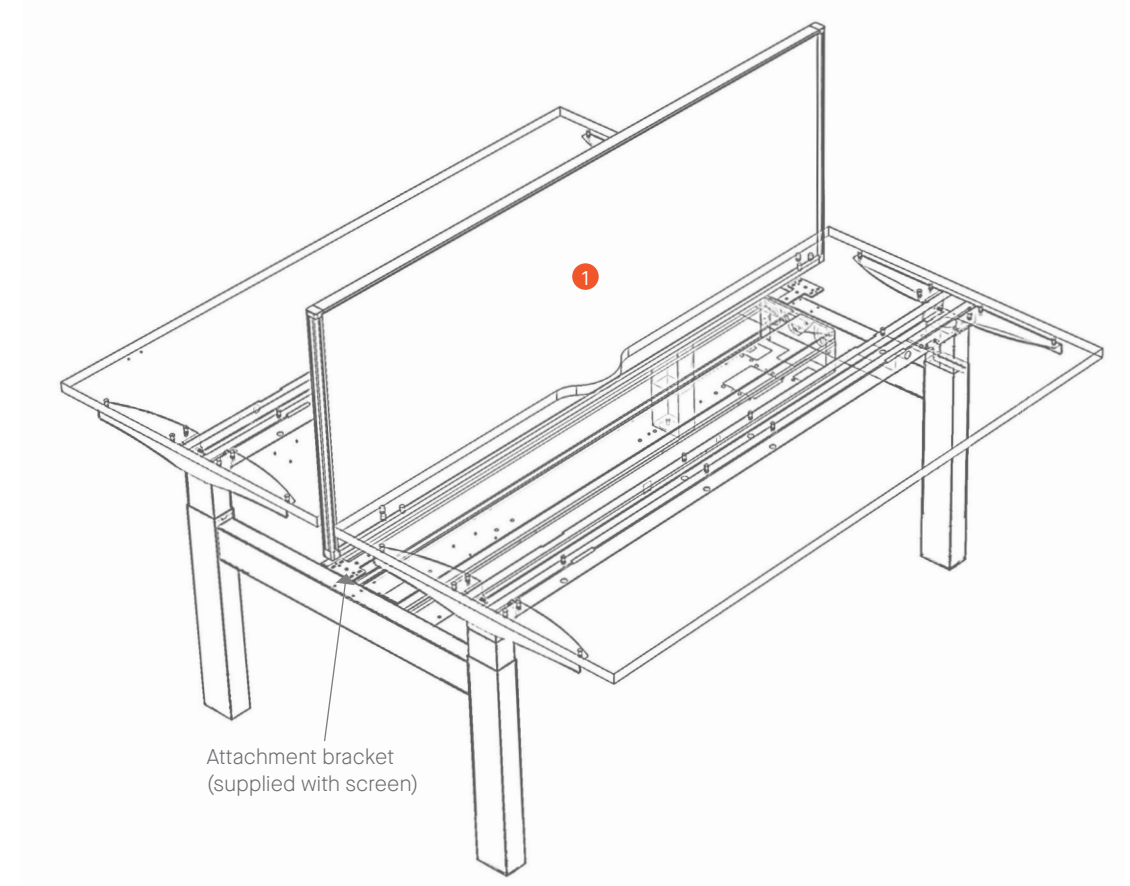

	Code	Description	QTY
1	CHPUSHA2660	Desktop Screen with Standard Frame for HA Bench Supplied with attachment bracket	1

PRODUCT PRICING

CHEMISTRY PLUS HEIGHT ADJUSTABLE – Back to Back Bench

		Width (inch)						
		48" W	54" W	60" W	66" W	72" W	78" W	
<p>Back to Back Bench HA Dual Stage 50" Depth</p>	Height adjustable between 22.5" – 48.5"	<b>CHPDSAEB4850</b> 3,770	<b>CHPDSAEB5450</b> 3,820	<b>CHPDSAEB6050</b> 3,858	<b>CHPDSAEB6650</b> 3,915	<b>CHPDSAEB7250</b> 3,965	<b>CHPDSAEB7850</b> 4,015	Code TFL
	Height adjustable between 22.5" – 48.5"	<b>CHPDSAEB4862</b> 3,833	<b>CHPDSAEB5462</b> 3,903	<b>CHPDSAEB6062</b> 3,930	<b>CHPDSAEB6662</b> 3,958	<b>CHPDSAEB7262</b> 3,985	<b>CHPDSAEB7862</b> 4,095	Code TFL
<p>Desk Mounted Cable Tray</p>	One required per desktop	<b>CHPDSACT48</b> 155 SEE NOTE 1	<b>CHPDSACT54</b> 164 SEE NOTE 1	<b>CHPDSACT60</b> 177 SEE NOTE 1	<b>CHPDSACT66</b> 189 SEE NOTE 1	<b>CHPDSACT72</b> 220 SEE NOTE 1	<b>CHPDSACT78</b> 239 SEE NOTE 1	Code Price
	Carries cables from desk mounted cable tray to bench trough	<b>FBABVCM</b> 148 SEE NOTE 1						Code Price
<p>Vertical Cable Riser</p>	Conceals cables from bench trough to the floor	<b>CHPUSACRD</b> 279 SEE NOTE 1						Code Price
	Mounts to underside of desk to hold computer tower	<b>CHPMUSCPUH</b> 306 SEE NOTE 1						Code Price
<p>Back to Back Linking Tray &amp; Cover</p>	Connects bench frames to create a 1" gap between work surfaces for safety	<b>CHPUSAEBLNK</b> 175 SEE NOTE 1						Code Price

Note 1: Available in Black, White, and Silver.

All prices listed in USD \$

Ships KD = Knock Down (Assembly Required)

Finishes & Features Available...

TFL (1")	HD Highland Oak   UM Urban Maple   WH White   AT Autumn   WK Winter Oak   SO Strata Oak   CW Carini Walnut   DN Denim   LY Clay   LG Light Gray
Standard Top Features	Starter desks have scalloped cable access as standard
Leg / Cable Management Color	Silver   White   Black
Fabrics	Grade A Camira Era   Grade B Camira Lucia, Camira Nexus   Grade C Camira Blazer, Camira Blazer Lite, Camira Aquarius, Camira Main Line Flax, Camira Synergy, Camira Synergy 66
Acrylic Colors	Clear   Opaque Crystal   Opaque White   Opaque Green   Opaque Blue
Glass Colors	Clear   Gray Smoked

PRODUCT PRICING

CHEMISTRY PLUS HEIGHT ADJUSTABLE – Back to Back Bench Screens

		Width (inch)						
		48" W	54" W	60" W	66" W	72" W	78" W	
<p>Desktop Screen w/ Standard Frame for Back to Back HA Supplied with Fixing Bracket 26" High</p>	<b>CHPUSHA2648</b> 663 918 789 862 1,046 SEE NOTES 1 & 2	<b>CHPUSHA2654</b> 684 961 828 912 1,125 SEE NOTES 1 & 2	<b>CHPUSHA2660</b> 704 992 856 963 1,181 SEE NOTES 1 & 2	<b>CHPUSHA2666</b> 714 1,051 899 1,005 1,275 SEE NOTES 1 & 2	<b>CHPUSHA2672</b> 738 1,127 932 1,009 1,331 SEE NOTES 1 & 2	<b>CHPUSHA2678</b> 765 1,170 984 1,062 1,396 SEE NOTES 1 & 2	Code TFL Acrylic Grade A Grade B Grade C	
	<b>CHPUSTHA2648</b> 675 932 801 876 1,060 SEE NOTES 1 & 2	<b>CHPUSTHA2654</b> 698 975 841 927 1,139 SEE NOTES 1 & 2	<b>CHPUSTHA2660</b> 718 1,003 882 977 1,220 SEE NOTES 1 & 2	<b>CHPUSTHA2666</b> 726 1,064 911 1,020 1,289 SEE NOTES 1 & 2	<b>CHPUSTHA2672</b> 751 1,140 945 1,022 1,344 SEE NOTES 1 & 2	<b>CHPUSTHA2678</b> 776 1,184 997 1,073 1,410 SEE NOTES 1 & 2	Code TFL Acrylic Grade A Grade B Grade C	
<p>Desktop Screen Frameless Non-Pinnable Supplied with Fixing Bracket 26" High</p>	<b>CHPSF2648</b> 531 607 800 SEE NOTE 2	<b>CHPSF2654</b> 552 633 839 SEE NOTE 2	<b>CHPSF2660</b> 580 673 905 SEE NOTE 2	<b>CHPSF2666</b> 600 699 943 SEE NOTE 2	<b>CHPSF2672</b> 628 736 1,010 SEE NOTE 2	<b>CHPSF2678</b> 648 763 1,049 SEE NOTE 2	Code Grade A Grade B Grade C	
	<b>CHPSF2648P</b> 731 808 998 SEE NOTE 2	<b>CHPSF2654P</b> 773 854 1,057 SEE NOTE 2	<b>CHPSF2660P</b> 823 916 1,148 SEE NOTE 2	<b>CHPSF2666P</b> 865 963 1,209 SEE NOTE 2	<b>CHPSF2672P</b> 908 1,026 1,299 SEE NOTE 2	<b>CHPSF2678P</b> 961 1,074 1,361 SEE NOTE 2	Code Grade A Grade B Grade C	
<p>Desktop Glass Screen 26" High</p>	<b>CHGSHA2648</b> 574 SEE NOTE 3	<b>CHGSHA2654</b> 624 SEE NOTE 3	<b>CHGSHA2660</b> 726 SEE NOTE 3	<b>CHGSHA2666</b> 744 SEE NOTE 3	<b>CHGSHA2672</b> 783 SEE NOTE 3	<b>CHGSHA2678</b> 840 SEE NOTE 3	Code Price	
	<b>CHGSHAR48</b> 460 SEE NOTE 2	<b>CHGSHAR54</b> 475 SEE NOTE 2	<b>CHGSHAR60</b> 489 SEE NOTE 2	<b>CHGSHAR66</b> 561 SEE NOTE 2	<b>CHGSHAR72</b> 588 SEE NOTE 2	<b>CHGSHAR78</b> 619 SEE NOTE 2	Code Price	

Note 1: For use on back to back HA desks. (Includes fixing bracket to desk frame, do not order brackets separately). Stands 45" high from floor when fitted.

Note 2: Specify black, white, or silver metalwork.

Note 3: Specify Clear or Gray Smoked Glass. Must be ordered with a glass screen rail.

All prices listed in USD \$  
Ships KD = Knock Down (Assembly Required)

To specify your desk...

1. Think through the configuration of Desk you require
2. Select the Codes of the individual items you need to achieve your configuration
3. Choose Finishes where appropriate: 'top' finishes / frame color / fabric color / acrylic color
4. Consider supporting product, screens, cable management and accessories

PRODUCT PRICING

CHEMISTRY PLUS HEIGHT ADJUSTABLE – Back to Back Pallet Bench



	Width (inch)			Code TFL
	60" W	72" W	78" W	
Height adjustable between 22.5" - 48.5"	<b>CHPDSAEP6062</b> 3,963	<b>CHPDSAEP7262</b> 4,019	<b>CHPDSAEP7862</b> 4,099	



	Width (inch)			Code Price
	54" W	66" W	72" W	
One required per desktop	<b>CHPDSACT54</b> 164 SEE NOTES 1 & 4	<b>CHPDSACT66</b> 189 SEE NOTES 2 & 4	<b>CHPDSACT72</b> 220 SEE NOTES 3 & 4	



Carries cables from desk mounted cable tray to bench trough	<b>FBABVCM</b> 148 SEE NOTE 4	Code Price
---	-------------------------------------	---------------



Conceals cables from bench trough to the floor	<b>CHPUSACRD</b> 279 SEE NOTE 4	Code Price
--	---------------------------------------	---------------

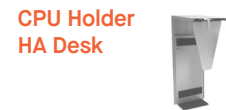

Mounts to underside of desk to hold computer tower	<b>CHPMUSCPUH</b> 306 SEE NOTE 4	Code Price
--	--	---------------



Connects desk frames to create a 1" gap between work surface for safety	<b>CHPUSAEPBLNK</b> 238 SEE NOTE 4	Code Price
---	--	---------------

Note 1: For use with 60" W Back to Back Pallet Bench Only

Note 2: For use with 72" W Back to Back Pallet Bench Only

Note 3: For use with 78" W Back to Back Pallet Bench Only

Note 4: Available in Black, White, and Silver.

All prices listed in USD \$

Ships KD = Knock Down (Assembly Required)

Finishes & Features Available...

TFL (1")	HD Highland Oak   UM Urban Maple   WH White   AT Autumn   WK Winter Oak   SO Strata Oak   CW Carini Walnut   DN Denim   LY Clay   LG Light Gray
Standard Top Features	Pallet benches have scalloped cable access as standard   Executive desks have a straight edge back edge as standard
Leg / Cable Management Colors	Silver   White   Black

PRODUCT PRICING

CHEMISTRY PLUS HEIGHT ADJUSTABLE – Executive Desk

Executive Desk

18" Depth Storage  
74" Overall Depth



Executive Desk

24" Depth Storage  
74" Overall Depth



Desk Top (inch)		Code TFL
72" x 30"	78" x 30"	
<b>CHAE723ONS</b> 7,346 SEE NOTES 1, 2, & 3	<b>CHAE783ONS</b> 7,509 SEE NOTES 1, 2, & 3	
<b>CHAE723ODS</b> 7,471 SEE NOTES 1, 2, & 3	<b>CHAE783ODS</b> 7,627 SEE NOTES 1, 2, & 3	Code TFL

Note 1: All integrated cable management.

Note 2: Please specify left (L) or right (R) hand version when ordering. Right hand shown.

Note 3: For integrated port holes, please add an extra \$250. Port holes are located at the front left, center, and right of the desk. Add "P" to the end of the item code (ie: CHAE723ONSP-R)

All prices listed in USD \$

Ships KD = Knock Down (Assembly Required)

To specify your desk...

1. Think through the configuration of Desk you require
2. Select the Codes of the individual items you need to achieve your configuration
3. Choose Finishes where appropriate: 'top' finishes / frame color / fabric color / acrylic color
4. Consider supporting product, screens, cable management and accessories

# CHEMISTRY ACCESSORIES

Clear and organized spaces are known for enhancing efficiency in the office, Senator's range of desk accessories provide a place for everything to maximize productivity at the workstation. Seamlessly integrating with the Chemistry range, the variety of accessories available from pen pots and whiteboards to tablet holders are designed to support the diverse needs of different working styles, by allowing users to personalize their own workspaces.

## CHEMISTRY ACCESSORIES

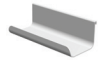
<p><b>Pen Pot with Rail Holder</b></p> 	<p><b>DAPPH</b> <b>72</b></p> <p>SEE NOTE 1</p>	Code Price
<p><b>Pen Tray</b></p> 	<p><b>DAPT</b> <b>61</b></p> <p>SEE NOTE 1</p>	Code Price
<p><b>Tablet Holder</b></p> 	<p><b>DATH</b> <b>55</b></p> <p>SEE NOTE 1</p>	Code Price
<p><b>Paper Tray Hanger</b></p> 	<p><b>DAPTHA4</b> <b>95</b></p> <p>SEE NOTE 1</p>	Code Price
<p><b>Paper Tray</b></p> 	<p><b>DAPTA4</b> <b>67</b></p> <p>SEE NOTE 1</p>	Code Price
<p><b>Hanger for Magnetic White Board</b></p> 	<p><b>DAWBH</b> <b>47</b></p> <p>SEE NOTE 1</p>	Code Price
<p><b>Magnetic White Board</b> 8.25in x 11.75in</p> 	<p><b>DAWBA4</b> <b>164</b></p> <p>SEE NOTE 1</p>	Code Price
<p><b>Magnetic White Board</b> 11.75in x 6.5in</p> 	<p><b>DAWBA3</b> <b>206</b></p> <p>SEE NOTE 1</p>	Code Price

Note 1: Only available in White.

All prices listed in USD \$



DESK ACCESSORIES

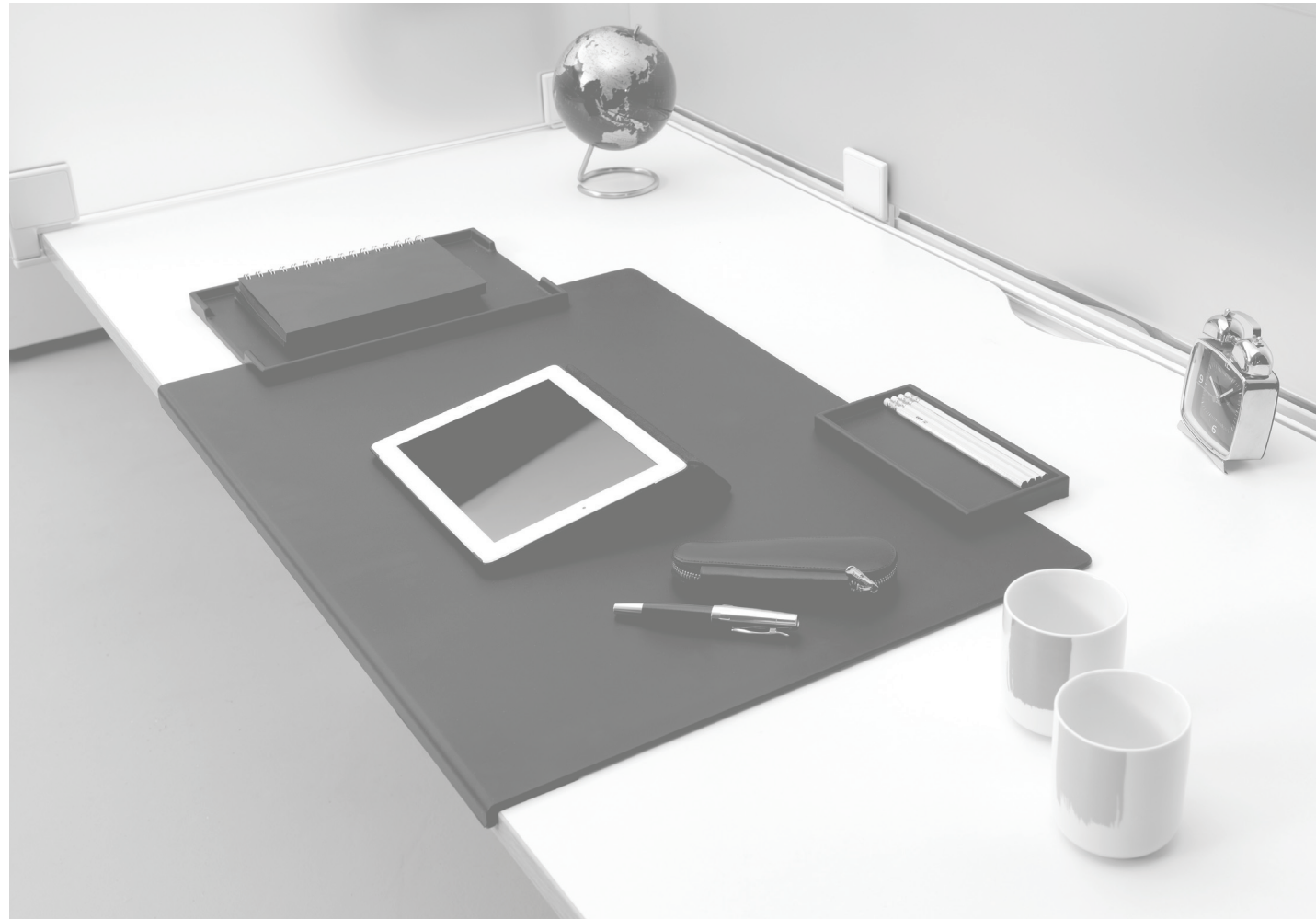

Organizing Desk Pad

30" x 20.5"

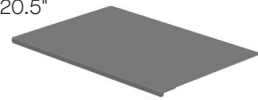

Organizing Desk Pad Accessory Set

Paper tray / pen tray / cupholder



<b>DAM01</b>	Code
<b>262</b>	Price
SEE NOTE 1	
<b>DAMACC</b>	Code
<b>342</b>	Price
SEE NOTE 1	

Note 1: Only available in Black.

All prices listed in USD \$

DESK ACCESSORIES



White Board Desk Divider Clip



Magnetic White Board

8.25in x 11.75in



Magnetic White Board

11.75in x 6.5in



Single Binder Holder with Pen Pot



Binder Holder



<b>DAWBDC</b>	Code
<b>30</b>	Price
SEE NOTE 1	
<b>DAWBA4</b>	Code
<b>164</b>	Price
SEE NOTE 1	
<b>DAWBA3</b>	Code
<b>206</b>	Price
SEE NOTE 1	
<b>DABHPP</b>	Code
<b>98</b>	Price
SEE NOTE 1	
<b>DABH</b>	Code
<b>138</b>	Price
SEE NOTE 1	

Note 1: Only available in White.

All prices listed in USD \$

## CHEMISTRY DESK ACCESSORIES

### M2 Desk Mounted Adjustable Monitor Arm

Please specify DC if desk clamped or CP for cableport fixed. Suitable for 1" tops.



<b>M2CLF17DC</b> <b>638</b> SEE NOTE 1	<b>M2CLF17CP</b> <b>638</b> SEE NOTE 1	Code
		Price
<b>ADPSC</b> <b>423</b> SEE NOTE 2		Code
		Price
<b>ADPSS</b> <b>484</b>		Code
		Price

Note 1: All monitor arms are compatible with most flat screen monitors. Please ensure monitors have VESA mounting. Consult with the Sales Office for more details.

Note 2: Available in White or Black. Please specify when ordering.

All prices listed in USD \$

### Above Desk Power (3-Prong Plug)

- Above Table
- White or Black
- Two power outlets
- 1 powered USB-A
- 1 powered USB-C
- 10 ft power cord w/ 3-prong plug



### Above Desk Power (Hardwire)

- Above Table
- White or Black
- Two power outlets
- 1 powered USB-A
- 1 powered USB-C
- 10 ft hardwire infeed



## CHEMISTRY POWER

### 84 System Hardwire Infeeds 8 Wire 4 Circuit

For Single, Inline, and Bench desk power block options



### Single Desk Electrical Kit

- 1x power block
- 4x receptacles
- 1x jumper cable

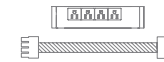

### Single Desk End of Run Block

- 1x power block
- 4x receptacles



### 84 System Hardwire Infeeds 8 Wire 4 Circuit

- 1x power block
- 8x receptacles
- 1x jumper cable

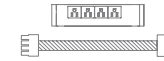

### 84 System Hardwire Infeeds 8 Wire 4 Circuit

- 1x power block
- 8x receptacles



Length (inches)		
72"	108"	144"
<b>72HWINF84</b> <b>231</b>	<b>108HWINF84</b> <b>296</b>	<b>144HWINF84</b> <b>363</b>

Single/Inline Desk Power Blocks					
Length (inches)					
48"	54"	60"	66"	72"	78"
<b>EK48SB8W4C</b> <b>372</b> SEE NOTE 1	<b>EK54SB8W4C</b> <b>382</b>	<b>EK60SB8W4C</b> <b>393</b>	<b>EK66SB8W4C</b> <b>405</b>	<b>EK72SB8W4C</b> <b>416</b>	<b>EK78SB8W4C</b> <b>426</b>

<b>EKEORSSB</b> <b>197</b>					
-------------------------------	--	--	--	--	--

Bench Desk Power Blocks					
Length (inches)					
48"	54"	60"	66"	72"	78"
<b>EK48DSB8W4C</b> <b>467</b> SEE NOTE 2	<b>EK54DSB8W4C</b> <b>479</b>	<b>EK60DSB8W4C</b> <b>490</b>	<b>EK66DSB8W4C</b> <b>499</b>	<b>EK72DSB8W4C</b> <b>512</b>	<b>EK78DSB8W4C</b> <b>522</b>

<b>EKEORDSB</b> <b>279</b>					
-------------------------------	--	--	--	--	--

Note 1: If ordering 120 degree single desks, you must specify a 48" single desk electrical kit.

Note 2: If ordering 120 degree back to back bench desks, you must specify bench desk electrical kit.

All prices listed in USD \$

# FINISHES

## CHEMISTRY FINISHES – Standard Top Finishes – TFL



Carini Walnut



Autumn



Strata Oak



Urban Maple



Highland Oak



Winter Oak

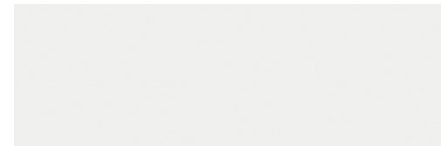

White



Light Gray



Denim



Clay

CHEMISTRY FINISHES

CONTRASTING EDGE BAND



Ply Effect Edging

All TFL (Edge 69) tops come with a matching edge band as standard. Contrasting edge band can be specified. Please contact customer service if you require a contrasting edge band.

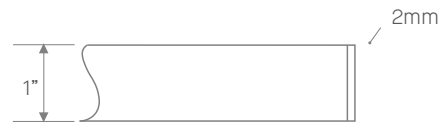

FRAME / LEG FINISHES



Black



White

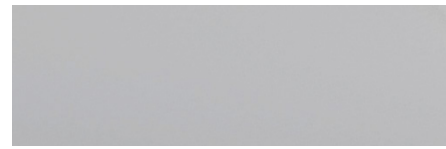

Silver

STANDARD PANEL FINISHES – Acrylic



Clear



Opaque Crystal



Opaque White



Opaque Green



Opaque Blue

GLASS SCREEN FINISHES



Clear



Gray Smoked

Large grid area for notes.