

**SENATOR**

**PODS**

PODS

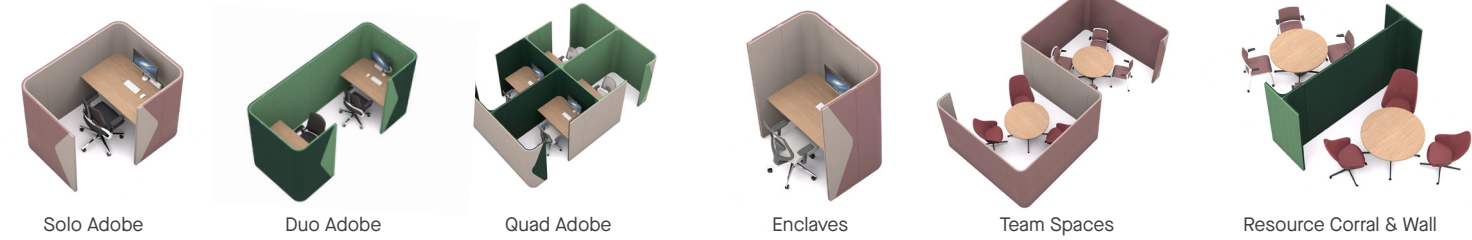

# SPACE WITHIN A SPACE

Within open plan office environments it is more common today for employees to share resources such as printers and scanners. Aside from the general ambient noise of an

office it is generally accepted that it is these kind of devices whirring into life that provide much of the acoustic and visual distraction of colleagues utilizing them.



**DESIGN**  
Senator

Our team of talented in house designers are responsible for creating elegant, innovative furniture designs which not only look beautiful, but minimise the impact on the world around us.

They come from all over the world, but are based in our Design Center located in a quiet Lancashire village just outside the Ribble Valley. Our dedicated facility is over three floors which include studios, a materials test center and prototyping lab.

**STANDARD FEATURES** (\*Selected models only)

- Internal Steel frame with multi layered foam construction
- Vertical panels upholstered in Camira Blazer fabric (two-tone is standard)
- Quick release panel connector system
- Leveling adjusters
- 1" TFL work surface\*
- Work surface power incorporating power outlets, powered USBs.\*
- Integral under work surface vertical cable management\*

- Low voltage LED task light\*
- Center panel able to support monitor\*
- Integral seat and backrest\*

**OPTIONAL FEATURES** (\*Selected models only)

- Dart accent color
- Coat Hanger
- Name Plate
- Two-tone upholstery on integrated seat units\*

**ACCESSORIES**

- Monitor Arms
- PU Desk Accessories
- Desk Top Accessories
- CPU Holders
- Electrical Accessories

**MATERIAL CONTENT**

Components are constructed of the following

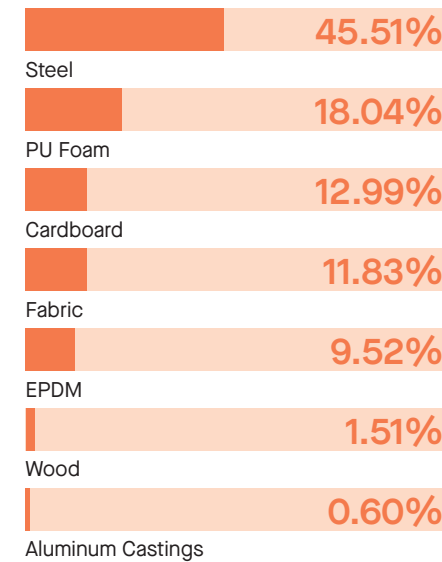

**RECYCLED CONTENT**

Contains up to 39.75% of Recycled Material

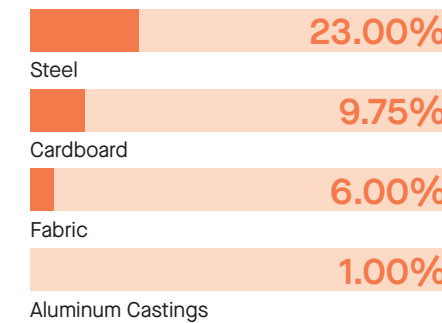

**RECYCLABILITY**

The range is 99% recyclable

99%

STATEMENT OF LINE

SOLO ABODE PODS

● Available  
□ Not available

Solo Abode & Solo Abode+  
79" Depth

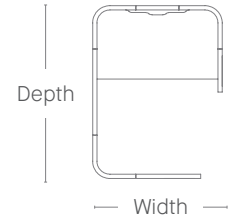

	Width (inch)	
Height (inch)	59"	69"
55"	●	●
71"	●	●

DUO & QUAD ABODE PODS

● Available  
□ Not available

Duo Abode Back to Back  
138" Depth

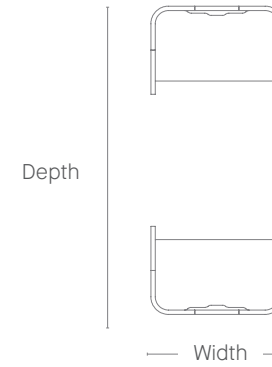

	Width (inch)
Height (inch)	59"
55"	●
71"	●

Solo Abode Exec  
79" Depth

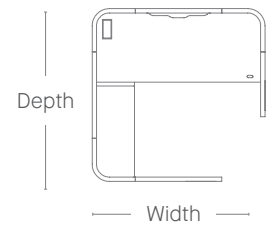

	Width (inch)
Height (inch)	79"
55"	●
71"	●

Duo Abode  
175" Depth

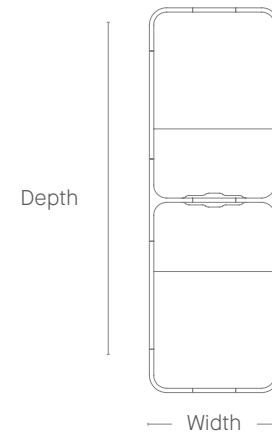

	Width (inch)
Height (inch)	59"
55"	●
71"	●

Solo Abode Lodge  
118" Depth

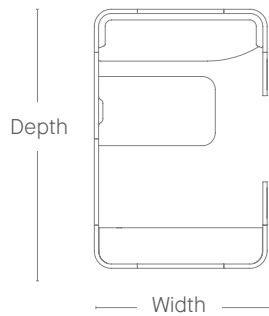

	Width (inch)
Height (inch)	79"
55"	●
71"	●

Quad Abode  
175" Depth

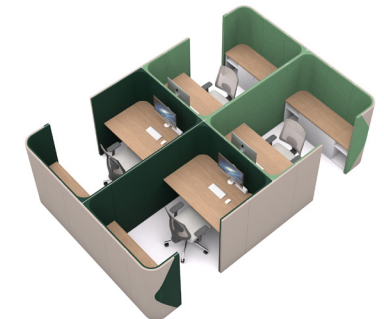
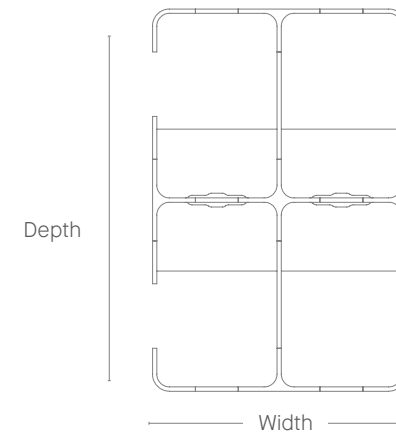

	Width (inch)
Height (inch)	116"
55"	●
71"	●

ENCLAVES

● Available  
□ Not available

Enclave One  
39" Depth

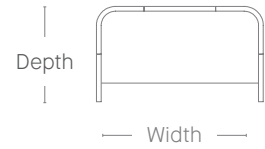

Height (inch)	Width (inch)
55"	59" ●
71"	59" ●

Enclave Two  
39" Depth

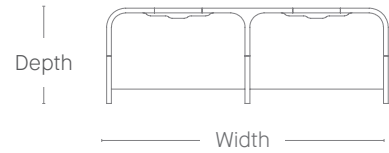

Height (inch)	Width (inch)
55"	116" ●
71"	116" ●

Enclave Three  
39" Depth

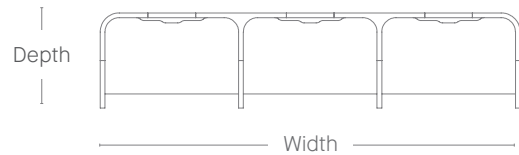

Height (inch)	Width (inch)
55"	173" ●
71"	173" ●

ENCLAVES

● Available  
□ Not available

Four Tandem  
156" Depth

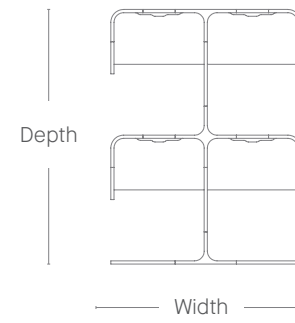

Height (inch)	Width (inch)
55"	116" ●
71"	116" ●

Windmill  
116" Depth

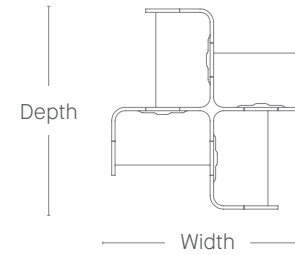

Height (inch)	Width (inch)
55"	116" ●
71"	116" ●

Four Person Back to Back  
77" Depth

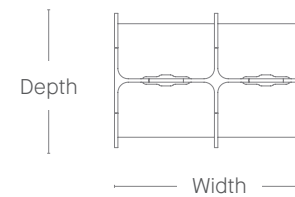

Height (inch)	Width (inch)
55"	116" ●
71"	116" ●

TEAM SPACES AND TEAM SPACES+

● Available  
 □ Not available

Team Spaces  
 98" Depth

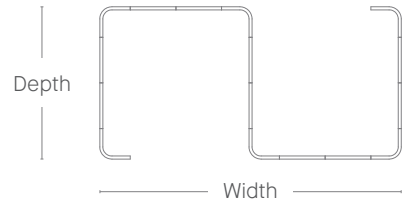

Height (inch)	Width (inch)
55"	194" □
71"	●

Team Spaces+  
 118" Depth

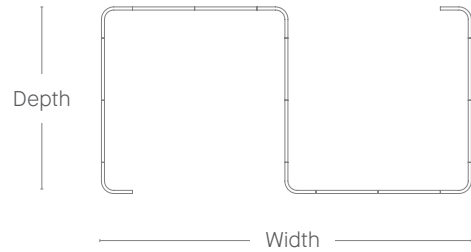

Height (inch)	Width (inch)
55"	234" □
71"	●

RESOURCE CORRAL AND WALL

● Available  
 □ Not available

Resource Corral  
 39" Depth

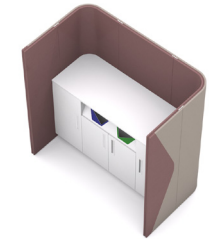
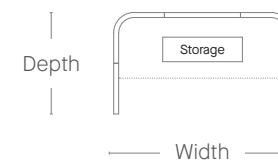

Height (inch)	Width (inch)
55"	69" □
71"	●

Wall  
 118" Depth

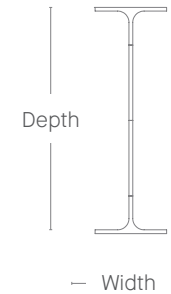

Height (inch)	Width (inch)
55"	37.50" □
71"	●

STATEMENT OF LINE

PODS

SOLO ABODE

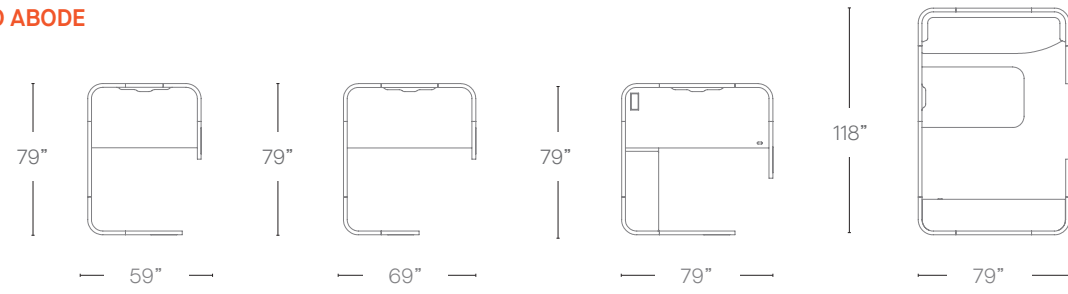

DUO & QUAD ABODE

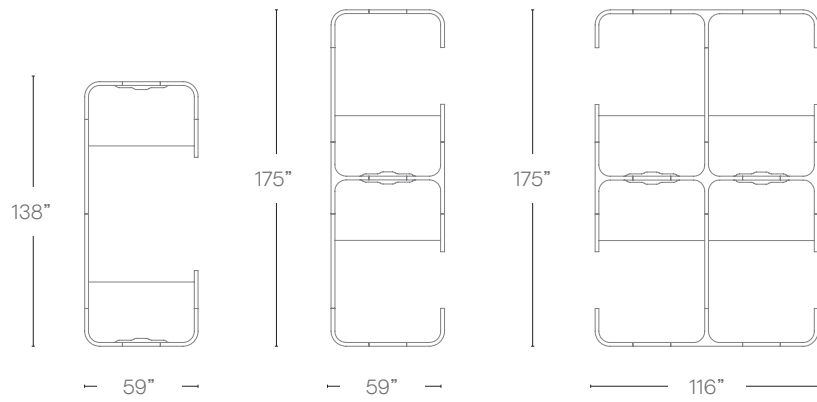

ENCLAVES

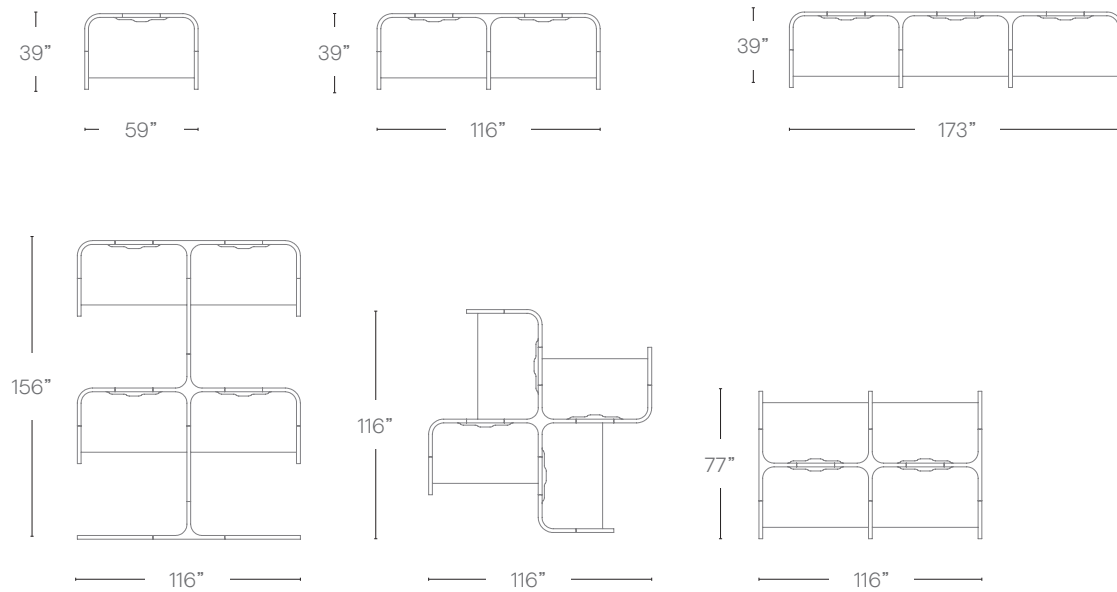

STATEMENT OF LINE

PODS

TEAM SPACES AND TEAM SPACES+

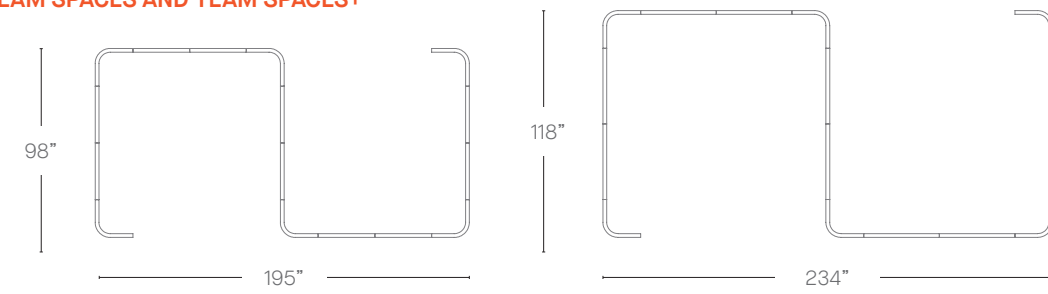

RESOURCE CORRAL AND WALL

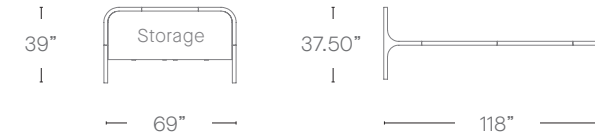

STORAGE

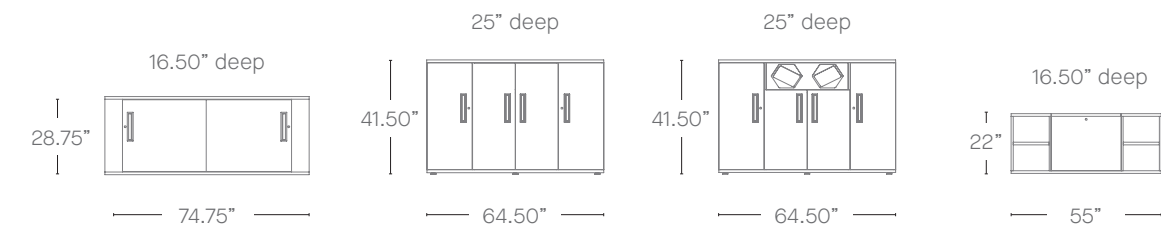

PRODUCT PRICING

PRODUCT PRICING

PODS

- Standard feature
- Not available
- Optional feature

	PDSA14L PDSA14R	PDSAP14L PDSAP14R	PDSE14L PDSE14R	PDSL14 PDSL18	PDBDA14 PDBDA18	PDDA14 PDDA18	PDQA14 PDQA18	PDEN114 PDEN118	PDEN214 PDEN218	PDEN314 PDEN318	PDEN4IN14 PDEN4IN18	PDEN4BB14 PDEN4BB18	PDEN4W14 PDEN4W18	PDTS18 Team Spaces	PDTSP18 Team Spaces+	PDWA18 Wall	PDRC18 Resource Corral
	Solo Abode	Solo Abode+	Solo Abode Exec	Solo Abode Lodge	Duo Abode Back to Back	Duo Abode	Quad Abode	Enclave One	Enclave Two	Enclave Three	Enclave Four Tandem	Enclave Four Person Back to Back	Enclave Windmill				
Weight	□	□	□	□	□	□	□	□	□	□	□	□	□	□	□	□	□
Internal steel frame with multi layered foam construction	●	●	●	●	●	●	●	●	●	●	●	●	●	●	●	●	●
Vertical panels upholstered in Camira Blazer fabric (two-tone is standard)	●	●	●	●	●	●	●	●	●	●	●	●	●	●	●	●	●
Quick release panel connector system	●	●	●	●	●	●	●	●	●	●	●	●	●	●	●	●	●
Leveling adjusters	●	●	●	●	●	●	●	●	●	●	●	●	●	●	●	●	●
1" TFL work surface, Edge 69	●	●	●	●	●	●	●	●	●	●	●	●	●	●	●	●	●
Integral under work surface vertical cable management	●	●	●	●	●	●	●	●	●	●	●	●	●	●	●	●	●
Integral seat and backrest	□	□	□	●	□	□	□	□	□	□	□	□	□	□	□	□	□
TFL storage unit	□	□	●	●	□	●	●	□	□	□	□	□	□	□	□	□	●
Dart accent color (otherwise dart will match interior fabric)	+\$50	+\$50	+\$50	+\$50	+\$50	+\$50	+\$50	+\$50	+\$50	+\$50	+\$50	+\$50	+\$50	+\$50	+\$50	+\$50	+\$50
Two-tone upholstery on integrated seat units (use the price for the highest grade of the fabric selected)	□	□	□	+\$100	□	□	□	□	□	□	□	□	□	□	□	□	□

ACCESSORIES

<b>HAPCH</b> Coat Hanger	\$116	
<b>HAPNP</b> Name Plate (Available in Black or White)	\$110	
<b>HAPWBA2</b> A2 Magnetic Dry Wipe Board with Hanger, 24" x 18" (Hanger available in Black or White)	\$232	
<b>HAPWBA3</b> A3 Magnetic Dry Wipe Board with Hanger, 18" x 13" (Hanger available in Black or White)	\$219	

\* Click here to see available Finishes.

Ships Semi-KD = Knock Down (Needs some assembly)



\* Click here to see available Fabrics.

To specify your pod...

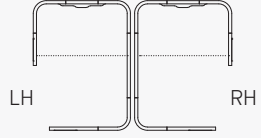
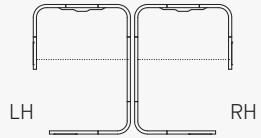

1. Check the Standard Features, Finishes and dimensions and select the version you require.
2. Choose the Fabric combination for the panels and the work surface, table top, or storage finish.
3. Select the Fabric Grade for the seat and backrest (where applicable). Refer to main price list for fabric options.
4. N.B. Pods comprise multiple elements; screens, work surface, storage and integrated seating (where applicable) each element is individually coded and priced above and must be added together to achieve the configuration as shown.

PRODUCT PRICING

PODS – Solo Abode & Solo Abode+

Code	SPECIFICATION	PLAN VIEW	PRICE
<b>PDSA14L</b> • Solo Abode (Left Hand) <b>PDSA14R</b> • Solo Abode (Right Hand)	Compact single person workspace, comprising seven mid height upholstered panels. Accompanying desk surface below. 59" w x 79" d x 55" h		12,905
<b>PDSA18L</b> • Solo Abode (Left Hand) <b>PDSA18R</b> • Solo Abode (Right Hand)	Compact single person workspace, comprising seven full height upholstered panels. Accompanying desk surface below. 59" w x 79" d x 71" h		15,101
<b>PRICE</b>			
<b>PDSAT</b> • Solo Abode worksurface 55" x 31.5"	Solo Abode worksurface incorporates a scallop to allow for a monitor arm and desk top power. Comes complete with cable tray and riser.	 x 1	1,297
<b>PDSAAET</b> • Solo Abode height adjustable worksurface 55" x 31.5"	Electric height adjustable worksurface, 22.5"–48.5" high incorporates a scallop to allow for a monitor arm and desk top power. Comes complete with cable tray and riser.	 x 1	1,799

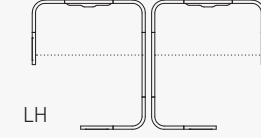
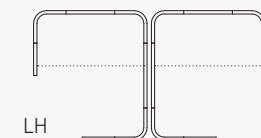

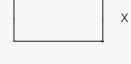
Code	SPECIFICATION	PLAN VIEW	PRICE
<b>PDSAP14L</b> • Solo Abode+ (Left Hand) <b>PDSAP14R</b> • Solo Abode+ (Right Hand)	Larger single person workspace, comprising seven mid height upholstered panels. Accompanying desk surface below. 69" w x 79" d x 55" h		12,917
<b>PDSAP18L</b> • Solo Abode+ (Right Hand) <b>PDSAP18R</b> • Solo Abode+ (Right Hand)	Larger single person workspace, comprising seven full height upholstered panels. Accompanying desk surface below. 69" w x 79" d x 71" h		15,101
<b>PRICE</b>			
<b>PDSAPT</b> • Solo Abode+ Worksurface 65" x 31.5"	Solo Abode+ worksurface incorporates a scallop to allow for a monitor arm and desk top power. Comes complete with cable tray and riser.	 x 1	1,362
<b>PDSAAEPT</b> • Solo Abode+ height adjustable worksurface 65" x 31.5"	Electric height adjustable worksurface, 22.5"–48.5" high incorporates a scallop to allow for a monitor arm and desk top power. Comes complete with cable tray and riser.	 x 1	1,850



\* Click here to see available Finishes.

Ships Semi-KD = Knock Down (Needs some assembly)

\* Click here to see available Fabrics.

To specify your pod...



1. Check the Standard Features, Finishes and dimensions and select the version you require.
2. Choose the Fabric combination for the panels and the work surface, table top, or storage finish.
3. Select the Fabric Grade for the seat and backrest (where applicable). Refer to main price list for fabric options.
4. N.B. Pods comprise multiple elements; screens, work surface, storage and integrated seating (where applicable) each element is individually coded and priced above and must be added together to achieve the configuration as shown.

PRODUCT PRICING

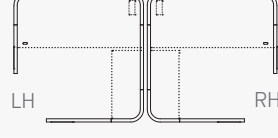
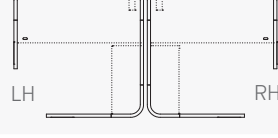
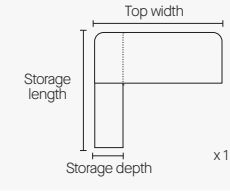
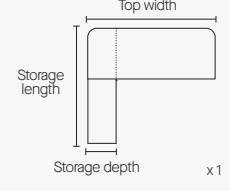
PODS – Solo Abode Exec & Solo Abode Lodge

Code	SPECIFICATION	PLAN VIEW	PRICE
<b>PDSE14L</b> • Solo Abode Exec (Left Hand) <b>PDSE14R</b> • Solo Abode Exec (Right Hand)	Generous single person exec workspace, comprising seven upholstered mid height panels. Accompanying fixed height or electric height adjustable work surface and integrated storage shown below. 79" w x 79" d x 55" h		14,107
<b>PDSE18L</b> • Solo Abode Exec (Left Hand) <b>PDSE18R</b> • Solo Abode Exec (Right Hand)	Generous single person exec workspace, comprising seven upholstered full height panels. Accompanying fixed height or electric height adjustable work surface and integrated storage shown below. 79" w x 79" d x 71" h		16,385
<b>PRICE</b>			
<b>PDSETL</b> • Executive Worksurface with Integrated Storage (Left Hand) <b>PDSETR</b> • Executive Worksurface with Integrated Storage (Right Hand)	Fixed height worksurface with integrated storage and flip top power. Storage unit comes complete with 1 x personal drawer 1 x filing drawer, open storage with shelves and visitor seat pad upholstered in Camira Blazer. Worksurface - 74.75" w x 31.5" d Storage - 74.75" w x 19.5" d	 x 1	5,988
<b>PDSEAE TL</b> • Height Adjustable Executive Worksurface with Integrated Storage (Left Hand) <b>PDSEAE TR</b> • Height Adjustable Executive Worksurface with Integrated Storage (Right Hand)	Electric height adjustable worksurface, 28.75"–48.5" high via an integrated desk switch. Built-in flip top power and storage unit comes complete with 1 x personal drawer, 1 x filing drawer, open storage with shelves and visitor seat pad upholstered in Camira Blazer. Worksurface - 74.75" w x 31.5" d Storage - 74.75" w x 19.5" d	 x 1	7,476

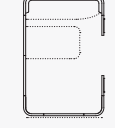
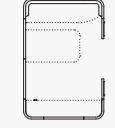
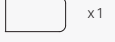

Code	SPECIFICATION	PLAN VIEW	PRICE
<b>PDSL14</b> • Solo Abode Lodge	Large single person workspace, comprising ten mid height panels. Accompanying desk, storage, and Solo lodge seating (for informal meetings) below. 79" w x 118" d x 55" h		19,324
<b>PDSL18</b> • Solo Abode Lodge	Large single person workspace, comprising ten mid height panels. Accompanying desk, storage, and Solo lodge seating (for informal meetings) below. 79" w x 118" d x 71" h		22,297
<b>PDSL T</b> • Solo Abode Lodge Worksurface	Single person work surface, fixed to the pod and supported by a single "I" leg. Surface incorporates a scallop to allow for desk top power and comes complete with riser. 53" x 31.50"	 x 1	1,437
<b>PDSL SL</b> • Solo Abode Lodge Storage Unit	Lockable sliding door storage offers a practical alternative to hinged doors. Comes complete with internal shelves and soft close fixings. 74.5" w x 16.5" d x 28.5" h	 x 1	2,719



Fabric Grade	0	1	2	3	4	5	6	7	8	9	C.O.M
<b>PDSL U</b> • Solo Abode Lodge Seat and Bench Elements 68.5" sw x 18" sd	–	2,589	2,766	3,006	3,298	3,591	3,949	4,360	4,828	5,362	2,589



PRODUCT PRICING

PODS – Duo Abode

Code	SPECIFICATION	PLAN VIEW	PRICE
<b>PDBDA14</b> • Duo Abode Back to Back	Two person back to back workspace, comprising ten mid height upholstered panels. Accompanying desk surfaces below.  59"w x 138"d x 55"h		17,926
<b>PDBDA18</b> • Duo Abode Back to Back	Two person back to back workspace, comprising ten full height upholstered panels. Accompanying desk surfaces below.  59"w x 138"d x 71"h		20,942
			<b>PRICE</b>
<b>PDSAT2</b> • Pair of Solo Abode workspaces 55" x 31.5"	Solo Abode workspace incorporates a scallop to allow for a monitor arm and desk top power. Comes complete with cable tray and riser.	x2	2,593
<b>PDSAAET2</b> • Pair of Solo Abode height adjustable workspaces 55" x 31.5"	Electric height adjustable workspace, 22.5"–48.5" high incorporates a scallop to allow for a monitor arm and desk top power. Comes complete with cable tray and riser.	x2	3,598



Code	SPECIFICATION	PLAN VIEW	PRICE
<b>PDDA14</b> • Duo Abode	Two single person workspaces adjoined by shared panels, comprising thirteen mid height upholstered panels. Accompanying desk surfaces below. Optional storage available below.  59"w x 175"d x 55"h		25,698
<b>PDDA18</b> • Duo Abode	Two single person workspaces adjoined by shared panels, comprising thirteen full height upholstered panels. Accompanying desk surfaces below. Optional storage available below.  59"w x 175"d x 71"h		30,096
			<b>PRICE</b>
<b>PDSAT2</b> • Pair of Solo Abode workspaces 55" x 31.5"	Solo Abode workspace incorporates a scallop to allow for a monitor arm and desk top power. Comes complete with cable tray and riser.	x2	2,593
<b>PDSAAET2</b> • Pair of Solo Abode height adjustable workspaces 55" x 31.5"	Electric height adjustable workspace, 22.5"–48.5" high incorporates a scallop to allow for a monitor arm and desk top power. Comes complete with cable tray and riser.	x2	3,598
<b>PDASF2</b> • Pair of Abode Storage Units 55" w x 31.5" d x 22" h	Personal storage with lockable soft close lid. Suitable for large personal belongings. Complete with two open storage units with adjustable shelves.	x2	3,034

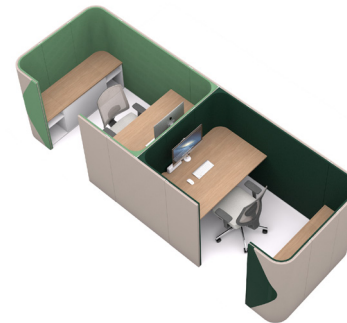

\* Click here to see available Finishes.

\* Click here to see available Fabrics.

Ships Semi-KD = Knock Down (Needs some assembly)

PRODUCT PRICING

PODS – Quad Abode

Code	SPECIFICATION	PLAN VIEW	PRICE
<b>PDQA14</b> • Quad Abode	Four single person workspaces adjoined by shared panels, comprising twenty one mid height upholstered panels. Accompanying desk surfaces and optional storage available below.  116"w x 175"d x 55"h		42,182
<b>PDQA18</b> • Quad Abode	Four single person workspaces adjoined by shared panels, comprising twenty one full height upholstered panels. Accompanying desk surfaces and optional storage available below.  116"w x 175"d x 71"h		50,004
			<b>PRICE</b>
<b>PDSAT4</b> • Four Solo Abode workspaces 55" x 31.5"	Solo Abode workspace incorporates a scallop to allow for a monitor arm and desk top power. Comes complete with cable tray and riser.	x4	5,815
<b>PDSAAET4</b> • Four Solo Abode height adjustable workspaces 55" x 31.5"	Electric height adjustable workspace, 22.5"–48.5" high incorporates a scallop to allow for a monitor arm and desk top power. Comes complete with cable tray and riser.	x4	7,238
<b>PDASF4</b> • Four Abode Storage Units 55" w x 31.5" d x 22" h	Personal storage with lockable soft close lid. Suitable for large personal belongings. Complete with two open storage units with adjustable shelves.	x4	6,067

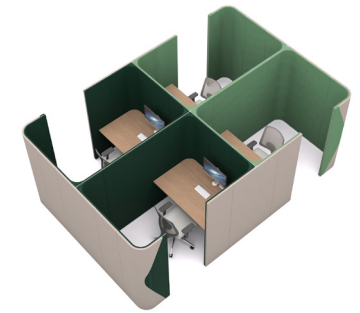

To specify your pod...

1. Check the Standard Features, Finishes and dimensions and select the version you require.
2. Choose the Fabric combination for the panels and the work surface, table top, or storage finish.
3. Select the Fabric Grade for the seat and backrest (where applicable). Refer to main price list for fabric options.
4. N.B. Pods comprise multiple elements; screens, work surface, storage and integrated seating (where applicable) each element is individually coded and priced above and must be added together to achieve the configuration as shown.

PRODUCT PRICING

PODS – Enclaves

Code	SPECIFICATION	PLAN VIEW	PRICE
<b>PDEN114</b> • Enclave One	Single person focus workspace comprises 5 mid height upholstered panels. Accompanying desk surfaces below. 59" w x 39" d x 55" h		9,356
<b>PDEN118</b> • Enclave One	Single person focus workspace comprises 5 full height upholstered panels. Accompanying desk surfaces below. 59" w x 39" d x 71" h		10,167
			<b>PRICE</b>
<b>PDSAT</b> • Solo workspace 55" x 31.5"	Solo Abode workspace incorporates a scallop to allow for a monitor arm and desk top power. Comes complete with cable tray and riser.	x1	1,297
<b>PDSAAET</b> • Solo Abode height adjustable workspace 55" x 31.5"	Solo Abode adjustable workspace between 22.5"–48.50" incorporates a scallop to allow for a monitor arm and desk top power. Comes complete with cable tray and riser.	x1	1,799



Code	SPECIFICATION	PLAN VIEW	PRICE
<b>PDEN214</b> • Enclave Two	Two person focus workspaces ajointed by shared panels, comprising eight mid height upholstered panels. Accompanying desk surfaces below. 116" w x 39" d x 55" h		14,642
<b>PDEN218</b> • Enclave Two	Two person focus workspaces ajointed by shared panels, comprising eight full height upholstered panels. Accompanying desk surfaces below. 116" w x 39" d x 71" h		17,682
			<b>PRICE</b>
<b>PDSAT2</b> • Pair of Solo workspaces 55" x 31.5"	Solo Abode workspace incorporates a scallop to allow for a monitor arm and desk top power. Comes complete with cable tray and riser.	x2	2,593
<b>PDSAAET2</b> • Pair of Solo Abode+ electric height adjustable workspaces 55" x 31.5"	Solo Abode adjustable workspace between 22.5"–48.50" incorporates a scallop to allow for a monitor arm and desk top power. Comes complete with cable tray and riser.	x2	3,598



Code	SPECIFICATION	PLAN VIEW	PRICE
<b>PDEN314</b> • Enclave Three	Three person focus workspaces ajointed by shared panels, comprising eleven mid height upholstered panels. Accompanying desk surfaces below. 173" w x 39" d x 55" h		20,510
<b>PDEN318</b> • Enclave Three	Three person focus workspaces ajointed by shared panels, comprising eleven full height upholstered panels. Accompanying desk surfaces below. 173" w x 39" d x 71" h		23,876
			<b>PRICE</b>
<b>PDSAT3</b> • Three Solo workspaces 55" x 31.75"	Solo Abode workspace incorporates a scallop to allow for a monitor arm and desk top power. Comes complete with cable tray and riser.	x3	3,889
<b>PDSAAET3</b> • Three Solo Abode+ electric height adjustable workspaces 55" x 31.5"	Solo Abode adjustable workspace between 22.5"–48.50" incorporates a scallop to allow for a monitor arm and desk top power. Comes complete with cable tray and riser.	x3	5,396



PRODUCT PRICING

PODS – Enclaves

Code	SPECIFICATION	PLAN VIEW	PRICE
<b>PDEN4IN14</b> • Enclave Four Tandem	Four person workspaces ajointed by shared panels, comprising nineteen mid height upholstered panels. Accompanying desk surfaces below. 116" w x 156" d x 55" h		37,810
<b>PDEN4IN18</b> • Enclave Four Tandem	Four person workspaces ajointed by shared panels, comprising nineteen full height upholstered panels. Accompanying desk surfaces below. 116" w x 156" d x 71" h		43,937
			<b>PRICE</b>
<b>PDSAT4</b> • Four Solo workspaces 55" x 31.5"	Solo Abode workspace incorporates a scallop to allow for a monitor arm and desk top power. Comes complete with cable tray and riser.	x4	5,185
<b>PDSAAET4</b> • Four Solo Abode+ electric height adjustable workspaces 55" x 31.5"	Solo Abode adjustable workspace between 22.5"–48.50" incorporates a scallop to allow for a monitor arm and desk top power. Comes complete with cable tray and riser.	x4	7,238



Code	SPECIFICATION	PLAN VIEW	PRICE
<b>PDEN4BB14</b> • Enclave Four Person Back to Back	Four person enclave back to back cluster adjointed by shared panels, comprising eleven mid height upholstered panels. Accompanying desk surfaces below. 116" w x 77" d x 55" h		22,540
<b>PDEN4BB18</b> • Enclave Four Person Back to Back	Four person enclave back to back cluster ajointed by shared panels, comprising eleven full height upholstered panels. Accompanying desk surfaces below. 116" w x 77" d x 71" h		26,130
			<b>PRICE</b>
<b>PDSAT4</b> • Four Solo workspaces 55" x 31.5"	Solo Abode workspace incorporates a scallop to allow for a monitor arm and desk top power. Comes complete with cable tray and riser.	x4	5,185
<b>PDSAAET4</b> • Four Solo Abode+ electric height adjustable workspaces 55" x 31.5"	Solo Abode adjustable workspace between 22.5"–48.50" incorporates a scallop to allow for a monitor arm and desk top power. Comes complete with cable tray and riser.	x4	7,238



\* Click here to see available Finishes.

Ships Semi-KD = Knock Down (Needs some assembly)



\* Click here to see available Fabrics.

To specify your pod...

1. Check the Standard Features, Finishes and dimensions and select the version you require.
2. Choose the Fabric combination for the panels and the work surface, table top, or storage finish.
3. Select the Fabric Grade for the seat and backrest (where applicable). Refer to main price list for fabric options.
4. N.B. Pods comprise multiple elements; screens, work surface, storage and integrated seating (where applicable) each element is individually coded and priced above and must be added together to achieve the configuration as shown.

PRODUCT PRICING

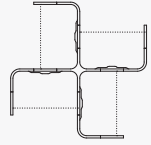
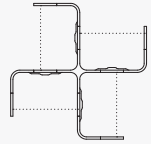

PODS – Enclaves

Code	SPECIFICATION	PLAN VIEW	PRICE
<b>PDEN4W14</b> · Enclave Windmill	Four-person Enclave Windmill cluster adjoined by shared panels, comprising thirteen mid height upholstered panels. Accompanying desk surfaces below. 116" w x 116" d x 55" h		23,750
<b>PDEN4W18</b> · Enclave Windmill	Four-person Enclave Windmill cluster adjoined by shared panels, comprising thirteen full height upholstered panels. Accompanying desk surfaces below. 116" w x 116" d x 71" h		27,863
<b>PDSAT4</b> · Four Solo worksurfaces 55" x 31.5"	Solo worksurface incorporates a scallop to allow for a monitor arm and desk top power.	 x4	5,185
<b>PDSAAET4</b> · Four Solo Abode+ electric height adjustable worksurfaces 55" x 31.5"	Solo Abode worksurface incorporates a scallop to allow for a monitor arm and desk top power. Comes complete with cable tray and riser.	 x4	7,238



PRODUCT PRICING

PODS – Resource Corral

Code	SPECIFICATION	PLAN VIEW	PRICE
<b>PDRC18</b> · Resource Corral	Corral for hiding away utility or electrical items such as printers, coat racks etc. Comprises five full height upholstered panels. Optional storage options available below. 69" w x 39" d x 71" h		10,399
<b>TFL</b>			
<b>PDRCDR</b> · Resource Corral Storage	Storage unit comprises four cupboards with height adjustable shelves and lockable doors. 64.50" w x 25" d x 41.5" h		2,088
<b>PDRCRS</b> · Resource Corral Recycling Storage	Storage unit comprises two lockable cupboards and two recycle compartments with integrated bins. Recycling consists of 1 x paper and 1 x plastic labelled compartments. 64.50" w x 25" d x 41.5" h		3,557

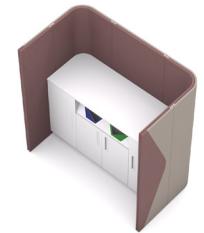

PODS – Team Spaces and Wall

Code	SPECIFICATION	PLAN VIEW	PRICE
<b>PDTSP18</b> · Team Spaces	Double meeting space optimizes interior space to accommodate a variety of furniture solutions. Team Space comprises sixteen full height upholstered panels. 194" w x 98" d x 71" h		35,533

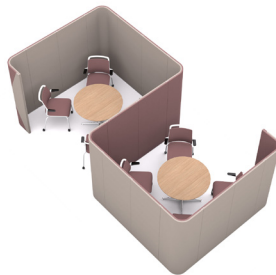

Code	SPECIFICATION	PRICE
<b>PDDTL</b> · Desktop Light	Freestanding desktop light in black, featuring a micro switch dimmer	POA
<b>ADPSC</b> · White or Black · 2 power outlets · 1 powered USB-A · 1 powered USB-C · 10 ft power cord with 3-prong plug	Above desk power, clamp mount <i>SEE NOTE 1</i>	423



Note 1: Available in White or Black. Please specify when ordering.

\* Click here to see available Finishes.

*Ships Semi-KD = Knock Down (Needs some assembly)*

\* Click here to see available Fabrics.

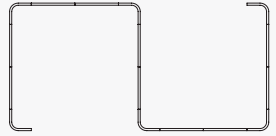
Code	SPECIFICATION	PLAN VIEW	PRICE
<b>PDTSP18</b> · Team Spaces+	Large double meeting space optimizes interior space to accommodate a variety of furniture solutions. Team Space comprises sixteen full height upholstered panels. 234" w x 118" d x 71" h		38,694

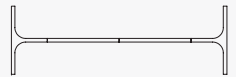

Code	SPECIFICATION	PLAN VIEW	PRICE
<b>PDWA18</b> · Wall	A freestanding wall used to divide space. Wall comprises four full height upholstered panels. 37.5" w x 118" d x 71" h		13,969



To specify your pod...

1. Check the Standard Features, Finishes and dimensions and select the version you require.
2. Choose the Fabric combination for the panels and the work surface, table top, or storage finish.
3. Select the Fabric Grade for the seat and backrest (where applicable). Refer to main price list for fabric options.
4. N.B. Pods comprise multiple elements; screens, work surface, storage and integrated seating (where applicable) each element is individually coded and priced above and must be added together to achieve the configuration as shown.

# FINISHES

## FINISHES

### PODS

#### FINISH OPTIONS

Vertical panels upholstered in Camira Blazer fabric two tone is standard

#### BLAZER FABRIC FINISHES

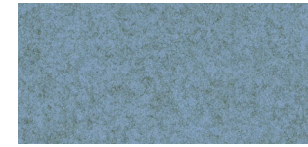

Plymouth



Fairfield

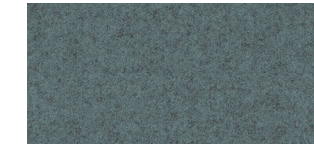

Latymer

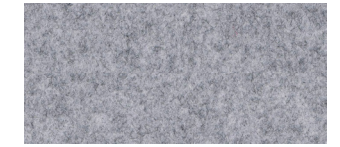

Silcoates



Silverdale

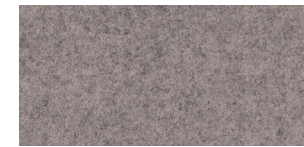

St Andrews



Trevelyan

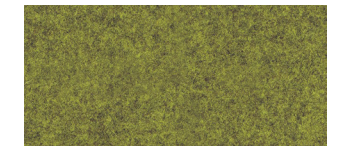

Ulster



Wellington



Wesley

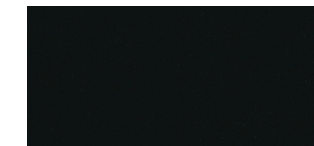

Napier

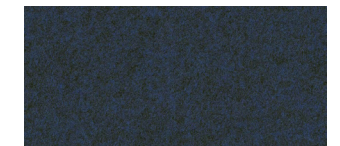

Newcastle



Newport

#### FRAME / LEG FINISHES



Black



White

Color images above are for reference only. Please verify with actual color sample.

PODS STANDARD TOP & STORAGE FINISHES – TFL



Carini Walnut



Autumn



Strata Oak



Urban Maple



Highland Oak



Winter Oak

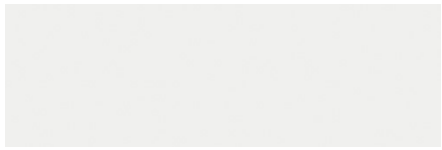

White



Light Gray



Denim

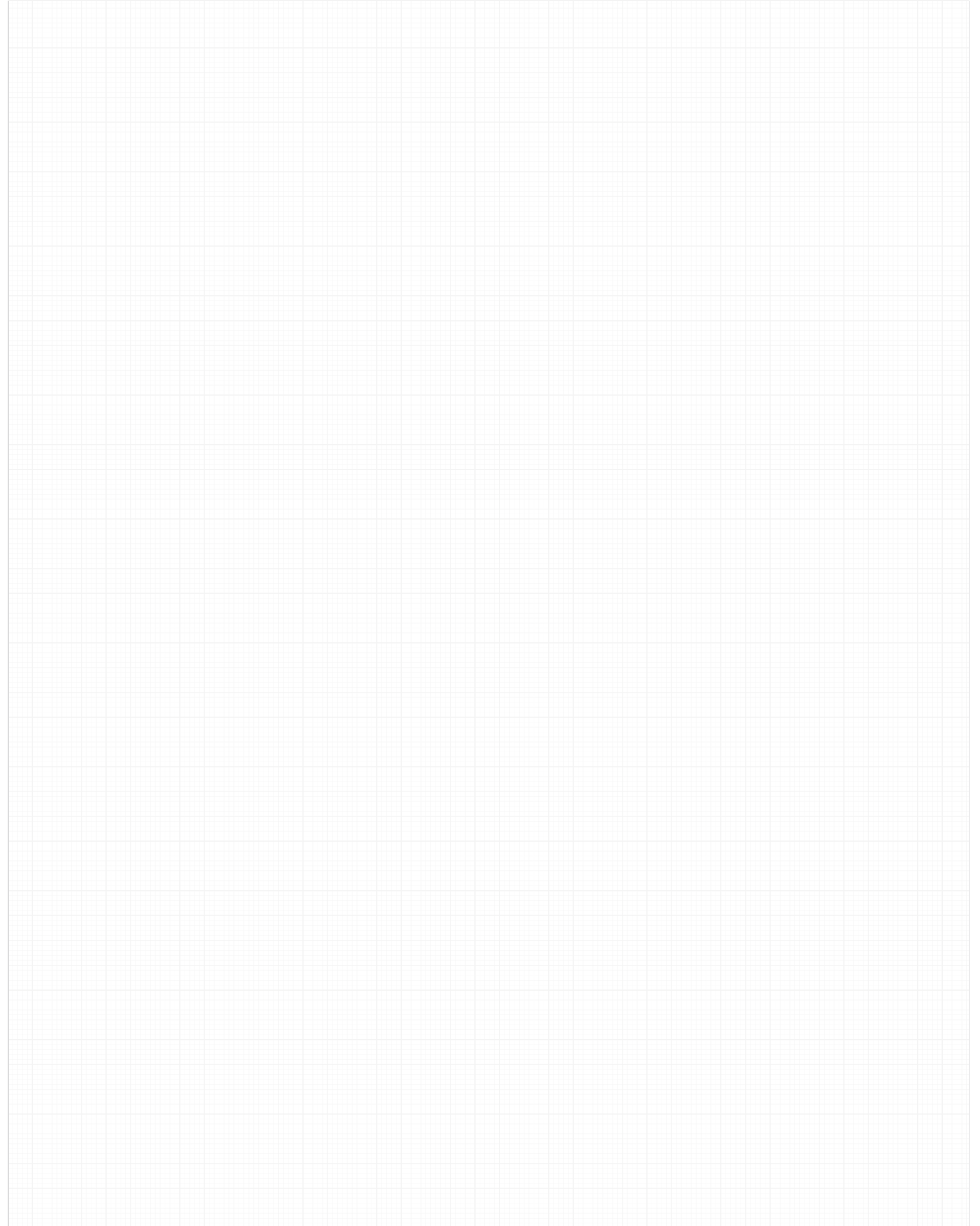

Color images above are for reference only. Please verify with actual color sample.